

Hitachi Cross-OS File Exchange Code Converter User's Guide

Hitachi Virtual Storage Platform G1000
Hitachi Virtual Storage Platform
Hitachi Universal Storage Platform V/VM
Hitachi TagmaStore® Universal Storage Platform
Hitachi TagmaStore® Network Storage Controller

FASTFIND LINKS

[Document Organization](#)

[Product Version](#)

[Getting Help](#)

[Contents](#)

© 2007-2014 Hitachi, Ltd. All rights reserved.

No part of this publication may be reproduced or transmitted in any form or by any means, electronic or mechanical, including photocopying and recording, or stored in a database or retrieval system for any purpose without the express written permission of Hitachi, Ltd.

Hitachi, Ltd., reserves the right to make changes to this document at any time without notice and assumes no responsibility for its use. This document contains the most current information available at the time of publication. When new or revised information becomes available, this entire document will be updated and distributed to all registered users.

Some of the features described in this document might not be currently available. Refer to the most recent product announcement for information about feature and product availability, or contact Hitachi Data Systems Corporation at <https://portal.hds.com>.

Notice: Hitachi, Ltd., products and services can be ordered only under the terms and conditions of the applicable Hitachi Data Systems Corporation agreements. The use of Hitachi, Ltd., products is governed by the terms of your agreements with Hitachi Data Systems Corporation.

Notice on Export Controls. The technical data and technology inherent in this Document may be subject to U.S. export control laws, including the U.S. Export Administration Act and its associated regulations, and may be subject to export or import regulations in other countries. Reader agrees to comply strictly with all such regulations and acknowledges that Reader has the responsibility to obtain licenses to export, re-export, or import the Document and any Compliant Products.

Hitachi is a registered trademark of Hitachi, Ltd., in the United States and other countries. Hitachi Data Systems is a registered trademark and service mark of Hitachi, Ltd., in the United States and other countries.

Archivas, Essential NAS Platform, Hi-Track, ShadowImage, Tagmaserve, Tagmasoft, Tagmasolve, Tagmastore, TrueCopy, Universal Star Network, and Universal Storage Platform are registered trademarks of Hitachi Data Systems Corporation.

AIX, AS/400, DB2, Domino, DS6000, DS8000, Enterprise Storage Server, ESCON, FICON, FlashCopy, IBM, Lotus, MVS, OS/390, RS/6000, S/390, System z9, System z10, Tivoli, VM/ESA, z/OS, z9, z10, zSeries, z/VM, and z/VSE are registered trademarks or trademarks of International Business Machines Corporation.

All other trademarks, service marks, and company names in this document or website are properties of their respective owners.

Microsoft product screen shots are reprinted with permission from Microsoft Corporation.



Contents

Preface	vii
Intended Audience	viii
Product Version.....	viii
Document Revision Level	viii
Changes in this Revision	viii
Document Organization	ix
Referenced Documents.....	x
Document Conventions.....	xi
Convention for Storage Capacity Values.....	xii
Accessing Product Documentation	xii
Getting Help.....	xiii
Comments	xiii
Overview of Code Converter	1-1
Overview of Code Converter	1-2
Code Converter Process.....	1-3
Code Converter Functions	2-1
Alphanumeric Character Conversion Function.....	2-3
Double-Byte Character Conversion Function.....	2-4
Non-Conversion Function (Simple Transmission)	2-5
Output Suppression Function	2-6
Numeric Conversion Function.....	2-7
Code Conversion Functions	2-8
Undefined Character Code Processing (Single-byte)	2-8
Undefined Character Code Processing (Double-byte).....	2-9
Shift Code Deletion Processing (Double-Byte and Single-Byte Combination) ..	2-10
Shift Code Insertion Processing (Double-Byte and Single-Byte Combination) .	2-11
Shift Code Insertion Suppression Processing (Double-Byte and Single-Byte Combination)	2-12

Short Output Field Processing	2-13
System Requirements and Installation	3-1
System Requirements	3-2
Overview of Code Converter Installation	3-3
Installation Media for UNIX-based Systems	3-4
Installation Media for Windows-based Systems.....	3-6
Installation and Uninstallation for UNIX Systems.....	3-7
Installing for UNIX Systems	3-7
Uninstalling for UNIX Systems.....	3-8
Upgrading or Downgrading.....	3-8
Installation and Uninstallation for Windows Systems.....	3-9
Installing for Windows Systems	3-9
Uninstalling for Windows Systems.....	3-9
Upgrading and Downgrading	3-10
License Key Input.....	3-11
License Key for UNIX Systems	3-11
License Key for Windows Systems.....	3-11
Using FX Code Converter.....	4-1
FX Code Converter User Process Flow	4-2
Database Data File Record Format.....	4-4
Code Conversion Using Fixed-Length Records.....	4-5
Code Conversion Using Variable-Length Records.....	4-5
Creating a Field Definition File	4-11
Using the Parameter Definition File to Associate Field Definition Files	4-16
Edit Option File	4-17
Mainframe-to-Open System Character Code Conversion.....	5-1
Overview of Character Code Conversion.....	5-2
Alphanumeric Field conversion (CHAR:OPK4)	5-3
Double-byte Character Field Conversion (KANJI:OPK1)	5-4
Double Byte Character Field Conversion (KANJI:OPK2)	5-5
Customizing the Code Conversion Table.....	5-6
Open-to-Mainframe Character Code Conversion.....	6-1
Overview.....	6-2
Alphanumeric Field Conversion (CHAR:OPK9)	6-3
Double Byte Character Field Conversion (KANJI:OPK6)	6-4
Double Byte Character Field Conversion (KANJI:OPK7)	6-5

Numeric Conversion	7-1
MTO Numeric Value Conversion Overview	7-2
Packed Decimal Conversion (NUM:OPA1)	7-3
Sign	7-4
Zero Suppression	7-5
Decimal Point	7-5
All-space Fields	7-6
Zoned Decimal Conversion (NUM:OPA2)	7-7
Sign	7-7
Zero Suppression	7-8
Decimal Point	7-9
All-space Fields	7-9
0-only Fields	7-9
Customizing the Code Conversion Table	8-1
Operation Overview	8-2
Utility Features	8-3
Definition Statement Syntax	8-4
Definition Statement Syntax Rules	8-4
Definition Statement Details	8-5
Command Syntax for UNIX Systems	8-7
Command Syntax for Windows Systems	8-8
Examples of the ccnv Utility	8-9
Customizing Character Conversion	8-9
Converting Private Characters	8-10
Outputting Code Conversion Table Information	8-11
Outputting to a File	8-12
Troubleshooting	9-1
Troubleshooting	9-2
Error Codes	9-3
ccnv Messages	9-3
FX Code Converter Error Codes and Basic Troubleshooting Guidelines	9-10
Calling the Support Center	9-17
Edit Option File	A-1
Edit Option File	A-1

HOSTBIG5.....	B-1
EBCDIC-ASCII Code Conversion.....	C-1
Acronyms and Abbreviations	



Preface

This document describes and provides instructions for installing and using Hitachi Cross-OS File Exchange (FX) Code Converter for the Hitachi RAID storage systems. The Hitachi RAID storage systems include the following models:

- Hitachi Virtual Storage Platform G1000 (VSP G1000)
- Hitachi Virtual Storage Platform (VSP)
- Hitachi Universal Storage Platform V/VM
- Hitachi TagmaStore Universal Storage Platform (USP)
- Hitachi TagmaStore Network Storage Controller (NSC)

Please read this document carefully to understand how to use this product, and maintain a copy for reference purposes.

This preface includes the following information:

- [Intended Audience](#)
- [Product Version](#)
- [Document Revision Level](#)
- [Changes in this Revision](#)
- [Document Organization](#)
- [Referenced Documents](#)
- [Document Conventions](#)
- [Convention for Storage Capacity Values](#)
- [Accessing Product Documentation](#)
- [Getting Help](#)
- [Comments](#)

Intended Audience

This document is intended for system administrators, Hitachi Data Systems representatives, and authorized service providers who are involved in installing, configuring, and operating the Hitachi RAID storage systems.

Readers of this document should be familiar with the following:

- Data processing and RAID storage systems and their basic functions.
- The Hitachi RAID storage systems and the user manual for the storage system (for example, *Hitachi Virtual Storage Platform G1000 Product Overview*, *Hitachi Virtual Storage Platform User and Reference Guide*).
- The graphical user interface (GUI) for the Hitachi RAID storage systems and the user manual for the GUI (for example, *Storage Navigator Users Guide*, *Hitachi Command Suite User Guide*).
- The applicable operating systems and application software for the open-systems hosts.

Product Version

This document revision applies to FX version 01-XX-68/00 and later.

Document Revision Level

Revision	Date	Description
MK-94RD253-P	February 2007	Preliminary Release
MK-94RD253-00	April 2007	Initial Release, supersedes and replaces MK-94RD253-P
MK-94RD253-01	May 2007	Revision 1, supersedes and replaces MK-94RD253-00
MK-94RD253-02	September 2007	Revision 2, supersedes and replaces MK-94RD253-01
MK-94RD253-03	October 2010	Revision 3, supersedes and replaces MK-94RD253-02
MK-94RD253-04	April 2014	Revision 4, supersedes and replaces MK-94RD253-03

Changes in this Revision

- Added support for the Hitachi Virtual Storage Platform G1000.

Document Organization

The following table provides an overview of the contents and organization of this document. Click the [chapter title](#) in the left column to go to that chapter. The first page of each chapter provides links to the sections in that chapter.

Chapter	Description
Overview of Code Converter	Provides an overview of how Code Converter operates and the interactions it has with other Hitachi software.
Code Converter Functions	Describes Code Converter functions and operations and when they are used by an operator.
System Requirements and Installation	Describes the system and installation requirements for Code Converter, and provides instructions for installing Code Converter.
Using Code Converter	Describes the operational sequence, how users perform operations and use the functions of Code Converter.
Mainframe-to-Open Systems Character Code Conversion	Describes the mainframe-to-open (mto) character code conversion process.
Open Systems-to-Mainframe Character Code Conversion	Describes the open-to-mainframe (otm) character code conversion process.
Numeric Conversion	Describes the considerations involved in performing numeric value conversions.
Customizing the Code Conversion Table	Describes the procedures for customizing the code conversion table for use with your specific conversion requirements.
Troubleshooting	Provides troubleshooting information, error codes, and customer support contact information.
Appendix A: Edit Option File	Describes the error codes and messages in the Code Converter Edit Options file.
Appendix B: HOSTBIG5	Provides an example of a Code Conversion table and a table of EBCDIC-to-ASCII conversion values.
Appendix C: EBCDIC-ASCII Code Conversion	Lists the EBCDIC-ASCII code conversions performed by the default code conversion table that is provided with FX.

Referenced Documents

Hitachi Cross-OS File Exchange:

- *Hitachi Cross-OS File Exchange User's Guide*, MK-96RD647

Hitachi Virtual Storage Platform G1000:

- *Hitachi Command Suite User Guide*, MK-90HC172
- *Mainframe System Administrator Guide*, MK-92RD8016
- *Product Overview*, MK-92RD8051

Hitachi Virtual Storage Platform:

- *Storage Navigator User Guide*, MK-90RD7027
- *User and Reference Guide*, MK-90RD7042

Hitachi Universal Storage Platform V/VM:

- *Storage Navigator User's Guide*, MK-96RD621
- *User and Reference Guide*, MK-96RD635

Hitachi TagmaStore USP/NSC:

- *Storage Navigator User's Guide*, MK-94RD206
- *Universal Storage Platform User and Reference Guide*, MK-94RD231
- *Network Storage Controller User and Reference Guide*, MK-95RD279

Document Conventions





This document uses the following terminology conventions:

Convention	Description
Hitachi RAID storage system, storage system	Refers to all configurations and models of the Hitachi RAID storage systems unless otherwise noted.

This document uses the following typographic conventions:

Convention	Description
Regular text bold	In text: keyboard key, parameter name, property name, hardware label, hardware button, hardware switch In a procedure: user interface item
<i>Italic</i>	Variable, emphasis, reference to document title, called-out term
screen text	Command name and option, drive name, file name, folder name, directory name, code, file content, system and application output, user input
< > angle brackets	Variable (used when italic is not enough to identify variable)
[] square brackets	Optional value
{ } braces	Required or expected value
vertical bar	Choice between two or more options or arguments

This document uses the following icons to draw attention to information:

Icon	Meaning	Description
	Tip	Provides helpful information, guidelines, or suggestions for performing tasks more effectively.
	Important	Provides information that is essential to the completion of a task.
	Caution	Warns that failure to take or avoid a specified action can result in adverse conditions or consequences (for example, loss of access to data).
	WARNING	Warns the user of severe conditions, consequences, or both (for example, destructive operation).

Convention for Storage Capacity Values

Physical storage capacity values (for example, disk drive capacity) are calculated based on the following values:

Physical capacity unit	Value
1 KB	1,000 (10^3) bytes
1 MB	1,000 KB or $1,000^2$ bytes
1 GB	1,000 MB or $1,000^3$ bytes
1 TB	1,000 GB or $1,000^4$ bytes
1 PB	1,000 TB or $1,000^5$ bytes
1 EB	1,000 PB or $1,000^6$ bytes

Logical storage capacity values (for example, logical device capacity) are calculated based on the following values:

Logical capacity unit	Value
1 block	512 bytes
1 cylinder	Mainframe: 870 KB Open-systems: § OPEN-V: 960 KB § Other than OPEN-V: 720 KB
1 KB	1,024 (2^{10}) bytes
1 MB	1,024 KB or $1,024^2$ bytes
1 GB	1,024 MB or $1,024^3$ bytes
1 TB	1,024 GB or $1,024^4$ bytes
1 PB	1,024 TB or $1,024^5$ bytes
1 EB	1,024 PB or $1,024^6$ bytes

Accessing Product Documentation

The user documentation for the Hitachi RAID storage systems is available on the Hitachi Data Systems Portal: <https://portal.hds.com>. Check this site for the most current documentation, including important updates that may have been made after the release of the product.

Getting Help

The Hitachi Data Systems customer support staff is available 24 hours a day, seven days a week. If you need technical support, log on to the Hitachi Data Systems Portal for contact information: <https://portal.hds.com>

Comments

Please send us your comments on this document: doc.comments@hds.com. Include the document title and number, including the revision level (for example, -07), and refer to specific sections and paragraphs whenever possible. All comments become the property of Hitachi Data Systems.

Thank you!

Overview of Code Converter

This chapter provides an overview of how Code Converter operates and the interactions it has with other Hitachi software.

- [Overview of Code Converter](#)
- [Code Converter Process](#)

Overview of Code Converter

The Code Converter, running on the Hitachi RAID storage systems using Hitachi Cross-OS File Exchange (FX), moves data between mainframe systems and open-systems servers. It enables the modification of data, including code conversion of various double-byte characters. It incorporates functions such as standard IBM double-byte code conversion.

The purpose of implementing the Code Converter is to build a mainframe/server data exchange system without having to develop a converter, as with IBM double-byte code conversion.

Note: The Hitachi Cross-OS File Exchange software consists of the File Access Library (FAL) and the File Conversion Utility (FCU) (FAL/FCU).

Code Converter Process

The Code Converter is a user's own coding (UOC) function that is called from FX File Conversion Utility. Figure 1-1 shows the positioning of the Code Converter and an outline of mainframe-to-open (mto) conversion operations, and Figure 1-2 shows open-to-mainframe (otm) conversion.

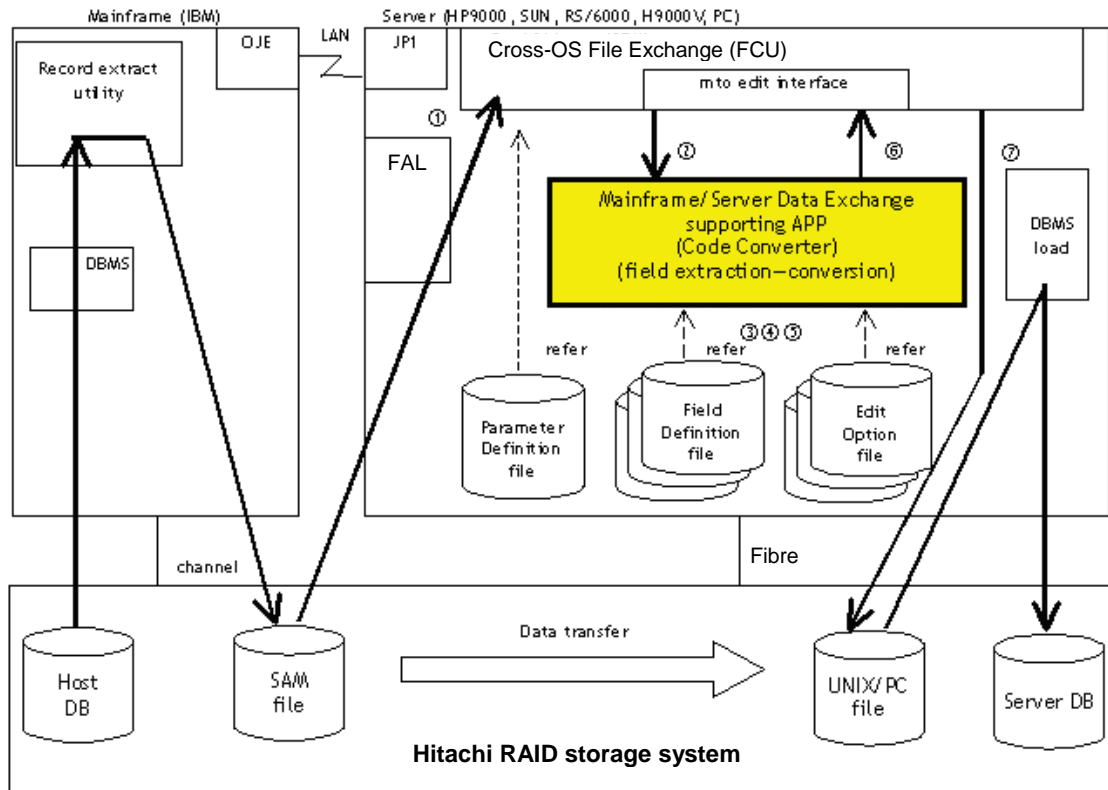

Figure 1-1 Mainframe-to-Open (mto) Conversion

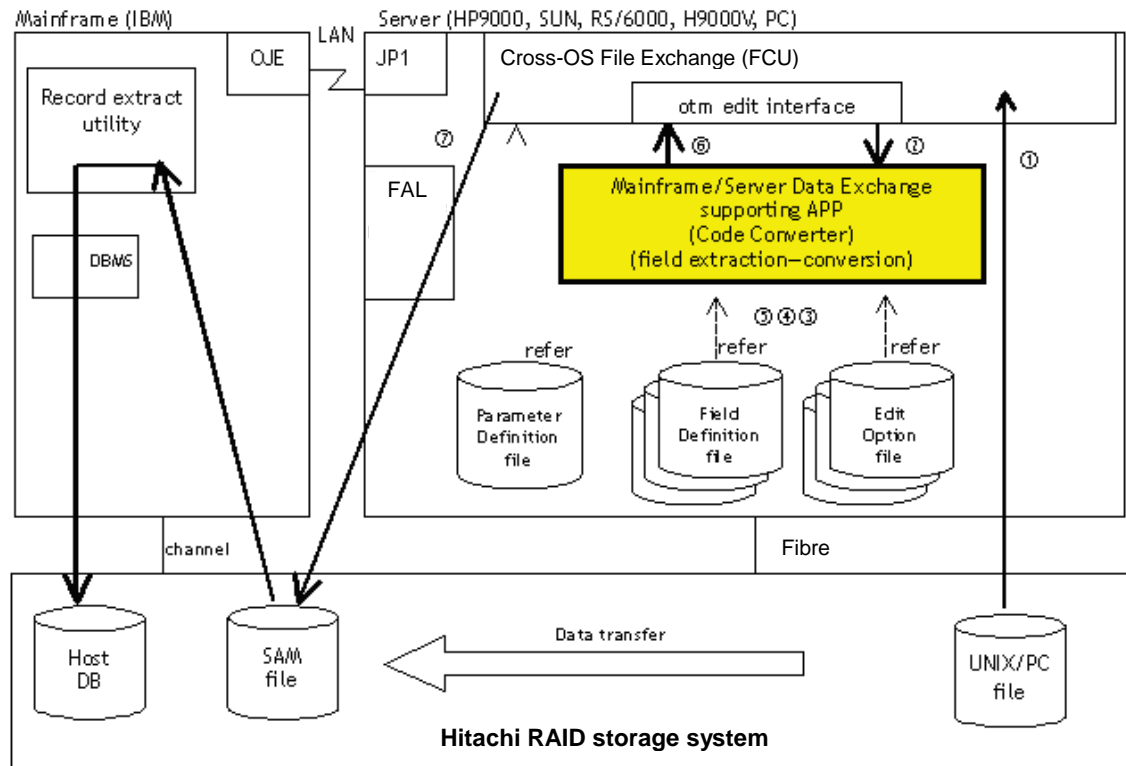

Figure 1-2 Open-to-Mainframe (otm) Conversion

Note 1: **JP1** and **OJE** (open job entry) are Hitachi-provided package products. They are required for communication between the mainframe and the open-systems servers to handle data transfer.

Note 2: A “field” represents a part of a record or can be the whole record, and is the basic processing unit of the FX Code Converter.

Basic flow of FX (mto) and Code Converter operations (refer to the circled numbers in Figure 1-1 and Figure 1-2):

1. The FX software reads the data of a mainframe FXmto volume.
2. If use of mto edit interface is declared with reference to the Parameter Definition file (which the user creates in advance), FX extracts the data for one record and passes the record data to Code Converter.
3. Code Converter extracts the data for one field and then determines the type of conversion specified referring to the Field Definition file (which the user creates in advance).
4. Perform conversion of double-byte characters etc. referring to the Field Definition file and the Edit Option file (standard file provided).
5. Repeat extraction processing and conversion processing of steps 3 and 4 for all fields in the record.

6. Code Converter returns the data after conversion to FX, after ending conversion processing of all fields for one record.
This process repeats iteratively from step 1 through step 6.
7. FX outputs the data for the record to the server file (UNIX, etc.).

Code Converter Functions

This chapter describes Code Converter's available functions, their concept of operations and when they are used by an operator.

- [Alphanumeric Character Conversion Function](#)
- [Double-Byte Character Conversion Function](#)
- [Non-Conversion Function \(Simple Transmission\)](#)
- [Output Suppression Function](#)
- [Numeric Conversion Function](#)
- [Code Conversion Functions](#)

Table 2-1 lists the Code Converter function specifications. The edit functions performed in connection with the alphanumeric and double-byte code conversions are covered in detail in [Code Conversion Functions](#).

Table 2-1 Code Converter Functions

Function	Specification	Remarks
Alphanumeric Character Conversion Function	Code conversion is performed only on single-byte field data characters. Mainframe à EBCDIC Open system à ASCII Note: Single-byte character codes are changed.	None
Double-Byte Character Conversion Function	Code conversion is performed on field data characters in which double-byte characters alone, or double-byte characters and single-byte characters are intermingled. Mainframe à IBM Traditional Chinese Open system à Big5 Note: double-byte character codes are changed.	None
Non-Conversion Function (Simple Transmission)	The data in the input field is not changed and is output.	Input data is not limited to characters.
Output Suppression Function	The data in the input field is not output.	The output field is shortened by the length of the non-conversion field that is not output.
Numeric Conversion Function	Code conversion is performed to the field data which consists only of numeric characters. Mainframe à packed decimal, zoned decimal Open system à numeric character A numeric character code is changed.	None

Alphanumeric Character Conversion Function

Code conversion is performed on a single-byte character data field. Figure 2-1 illustrates the process flow. The target coding system is as follows:

- Mainframe code set à EBCDIC
- Open-system code set à ASCII

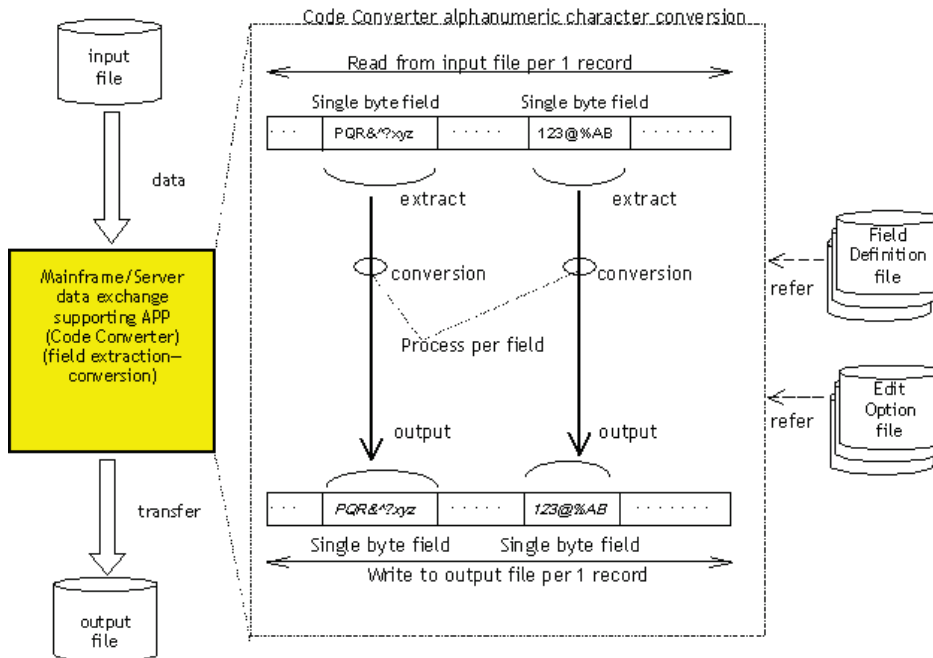

Figure 2-1 Alphanumeric Character Conversion Flow

Data is read from an input file per 1 record, the portion of the single-byte character field to convert is extracted, and the appointed alphanumeric character conversion is performed. Conversion is performed for every field, and the result is edited per 1 record and written to an output file.

The position from which single-byte character fields in a record are extracted and the output field length are determined by referring to the value specified in the "Field Definition file" created by the user (refer to [Creating a Field Definition File](#) for more information).

Detail specification (the type of conversion table to use etc.) of the alphanumeric character conversion method is controlled by the default specification parameter in the standard "Edit Option file" provided (refer to [Edit Option File](#) more information).

Double-Byte Character Conversion Function

Code conversion is performed on a data field which consists of the double-byte characters, or double-byte and single-byte characters that are intermingled. Figure 2-2 illustrates the process flow. The target coding system is as follows:

- Mainframe à IBM Traditional Chinese: In this case, EBCDIC single-byte characters are intermingled with double-byte characters
- Open system à Big5: In this case, ASCII single-byte characters are intermingled with double-byte characters.

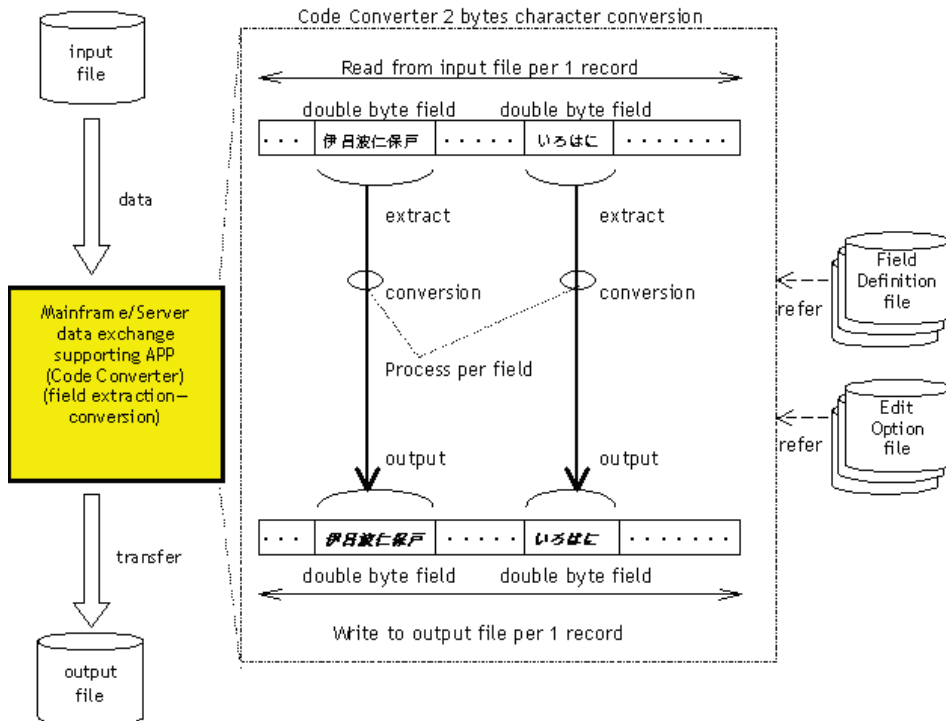

Figure 2-2 Double-byte Character Conversion Flow

Data is read from an input file per 1 record, the portion of the double-byte character field (single-byte character can be included in the field) to convert is extracted, and appointed double-byte character conversion is performed.

The conversion is as same as alphanumeric character conversion explained in [Alphanumeric Character Conversion Function](#).

Non-Conversion Function (Simple Transmission)

Data in input field is output without any processing. Input data is not limited to character codes. Figure 2-3 illustrates the process flow.

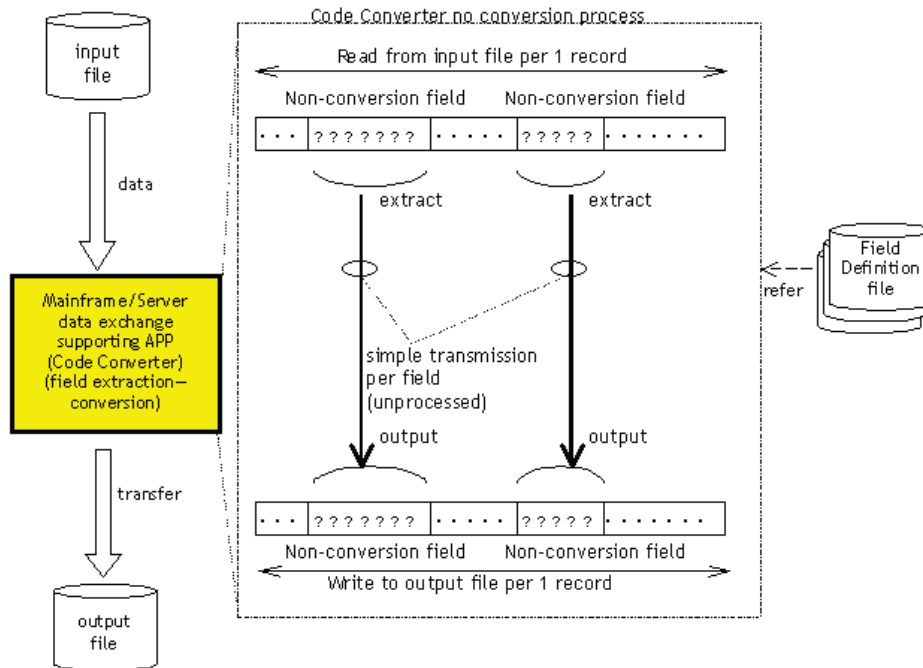

Figure 2-3 Non-conversion Process Flow

Data is read from an input file per 1 record, the portion of the non-conversion field (unprocessed) is extracted, and simple transmission is performed.

The position from which the non-conversion field in a record is extracted is determined by referring to the specified value in the "Field Definition file" created by the user (for details, see [Creating a Field Definition File](#)).

Note 1: For non-conversion fields, make sure that the output field length is the same as the input field length. If the description of output field length is omitted in the "Field Definition file", the default will be the same length as the input field.

Note 2: Since this processing method carries out only simple transmissions for non-conversion fields, the standard "Edit Option file" that is usually provided is not referred to here.

Output Suppression Function

Input field data is not output. The output record length is shortened and is not output. Figure 2-4 illustrates the process flow.

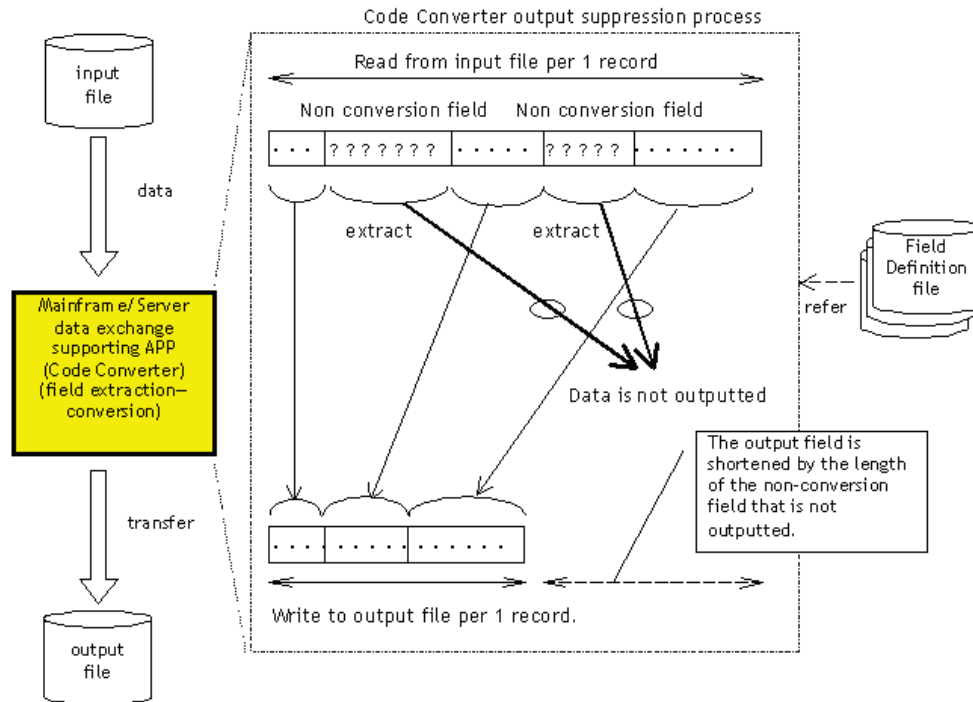

Figure 2-4 Output Suppression Function Flow

Data is read from an input file per 1 record; the portion of the output suppression field is extracted, and after reading, the data is discarded. The output field length of an output suppression field is always 0.

The position from which the output suppression field in a record is extracted is recognized by referring to the value specified in the "Field Definition file" created by the user (for details, see [Creating a Field Definition File](#)).

Note: Do not specify an output field length for the output suppression function. Since an output is suppressed, the standard "Edit Option file" provided is not referred to here.

Numeric Conversion Function

Code conversion is performed only on the numeric character data fields. Figure 2-5 illustrates the process flow. The target coding system is as follows.

- Mainframe à packed decimal or zoned decimal
- Open system à Numeric character

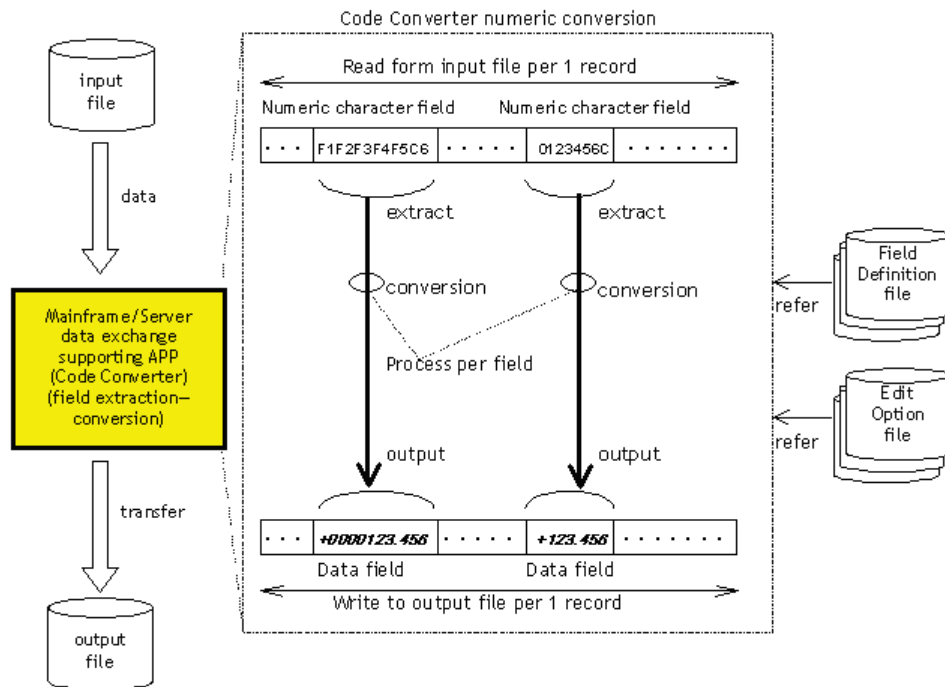

Figure 2-5 Numeric Conversion Function Process Flow

Data is read from an input file per 1 record, the portion of the numeric character field to convert is extracted, and the numeric character conversion is performed. Conversion is performed for every field, and the result is edited per 1 record, and written to an output file.

The position from which the numeric character field in a record is extracted and the output field length is determined by referring to the value specified in the "Field Definition file" created by the user (for details, see [Creating a Field Definition File](#)).

Specification of the details (sign position, the number of decimal digits, etc.) of the numeric character conversion method is controlled by the default specification parameter in the standard "Edit Option file" provided (for details, see [Edit Option File](#)).

Code Conversion Functions

Undefined Character Code Processing (Single-byte)

Figure 2-6 Illustrates the Single-byte undefined character code process.

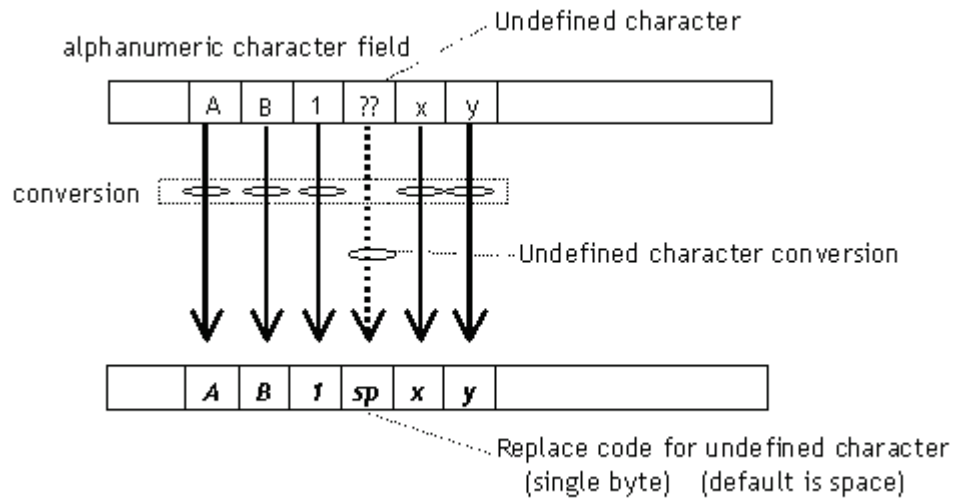

Figure 2-6 Undefined Character Code Processing (Single-byte)

In this situation, an undefined character (a valid character which is not defined in the conversion table) in an alphanumeric character conversion is replaced by a replacement code for undefined characters (single-byte space).

Undefined Character Code Processing (Double-byte)

Figure 2-7 illustrates the undefined character code process.

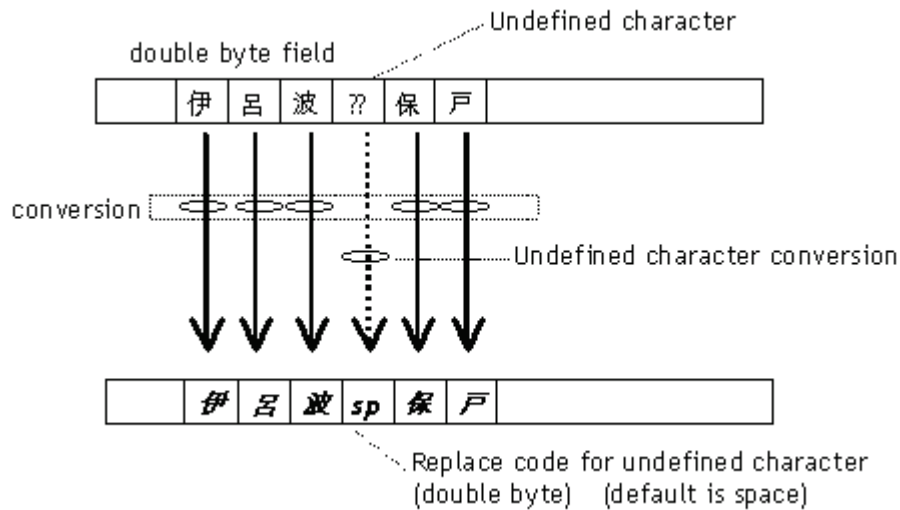

Figure 2-7 Undefined Character Code Processing (double-byte)

In this situation, an undefined character (a valid character which is not defined in the conversion table) in a double-byte character conversion is replaced by a replacement code for undefined characters (double-byte space).

When single-byte characters are intermingled with double-byte characters, either a single-byte space or a double-byte space is used as the replacement code according to the position in the field.

Shift Code Deletion Processing (Double-Byte and Single-Byte Combination)

Figure 2-8 illustrates the shift code deletion process.

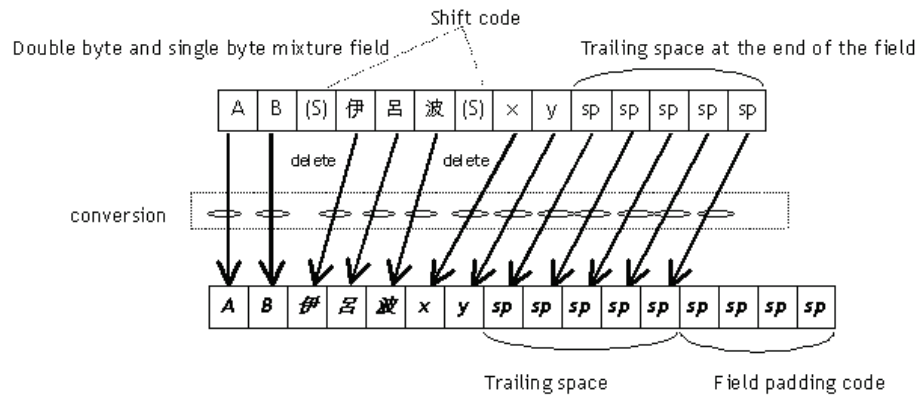

Figure 2-8 Shift Code Deletion Processing

When carrying out double-byte code conversion (double-byte and single-byte in the same field) from a coding system with a shift code to a coding system without a shift code, the shift codes are deleted. A shift code is a special code which shows the boundary of double-byte/single-byte characters. Data is left-aligned in the output field. Extra space in the output field is padded with the field padding code (double-byte or single-byte space).

Shift Code Insertion Processing (Double-Byte and Single-Byte Combination)

Figure 2-3 illustrates the shift code insertion process.

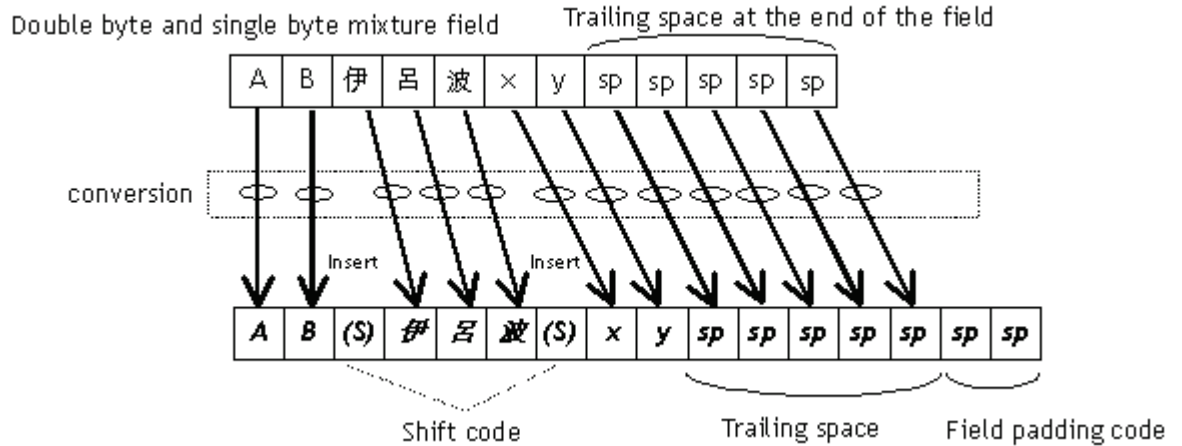

Figure 2-9 Shift Code Insertion Process

When carrying out double-byte code conversion (double-byte and single-byte in the same field) from a coding system without a shift code to a coding system with a shift code, a shift code can be inserted where necessary. A shift code is a special code which shows the boundary of double-byte/single-byte characters. If extra space still remains in the output field, it is filled up with a field padding code (double-byte/single-byte space).

Note: the end of input data is discarded when an output field area runs short as a result of inserting shift codes.

Shift Code Insertion Suppression Processing (Double-Byte and Single-Byte Combination)

Figure 2-10 illustrates the shift code insertion process.

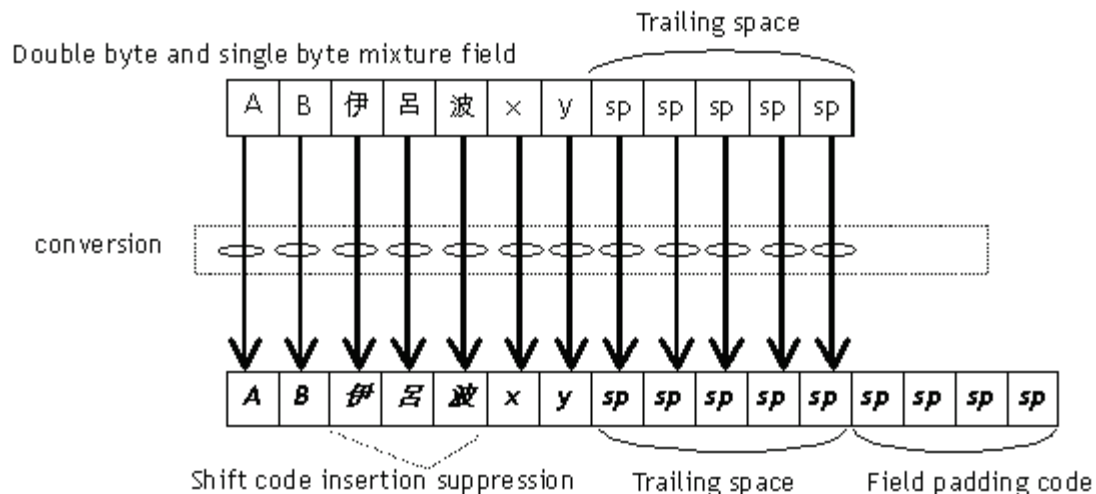

Figure 2-10 Shift Code Insertion Suppression Process

When double-byte code conversion (double-byte and single-byte in the same field) is carried out from a coding system without a shift code to a coding system with a shift code, the user can choose not to insert a shift code to the output field. A shift code is a special code which shows the boundary of double-byte/single-byte characters.

Note: It is necessary to additionally specify "TRAN_SHIFT_NO" for code conversion mode in the "Edit Option file". Normally, a shift code should be inserted.

Short Output Field Processing

Figure 2-11 illustrates the short output field process.

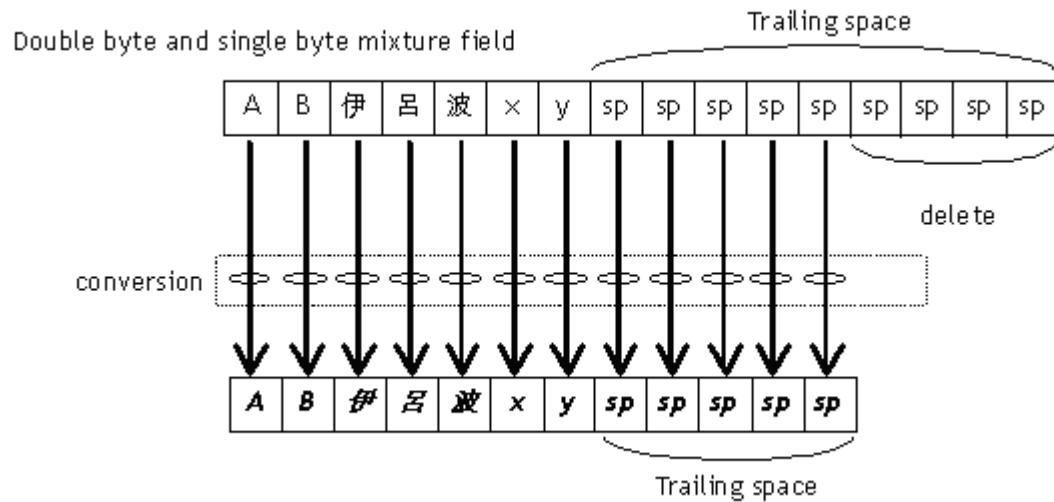

Figure 2-11 Short Output Field Processing

Note: the end of input data is discarded when the output field length specified in the "Field Definition file" is too short, or when the output field becomes short as a result of inserting shift codes.

System Requirements and Installation

This chapter describes the system and installation requirements for Code Converter. It also details how to install Code Converter on your system.

- [System Requirements](#)
- [Overview of the FX Code Converter Installation](#)
- [Installation Media for UNIX-based Systems](#)
- [Installation Media for Windows-based Systems](#)
- [Installing and Uninstalling for UNIX Systems](#)
- [Installation and Uninstallation for Windows Systems](#)
- [License Key Input](#)

System Requirements

The system requirements for the FX Code Converter are:

- FAL/FCU CD for the applicable open-system platform(s). See the *Hitachi Cross-OS File Exchange User's Guide* for details regarding the FAL/FCU software.

Note: FAL/FCU currently supports files larger than 2 GB.

- Hitachi RAID storage system:
 - FX Code Converter mto: the Hitachi RAID storage system must be configured with -B and/or -A FX volumes.
 - FX Code Converter otm: the Hitachi RAID storage system must be configured with -C and/or -A FX volumes.

Note: A license key is required for FX Code Converter operations. If you execute mto before inputting the license key code, a 0 byte file will be created. If this occurs, execute mto again after you have input the license key code. Use Storage Navigator to enter the license key. For instructions, see the *Storage Navigator User's Guide* for the storage system.

- Mainframe operating systems: MVS/ESA, MVS/XA

For the latest information on supported mainframe systems, contact your Hitachi Data Systems representative.

- UNIX operating systems: HP-UX, AIX, Solaris, Red Hat Linux, SUSE Linux

For the latest information on supported UNIX OS versions, contact your Hitachi Data Systems representative.

- PC server operating system: Microsoft Windows

For the latest information on supported Windows OS versions, contact your Hitachi Data Systems representative.

Overview of Code Converter Installation

Figure 3-1 shows an overview of the Code Converter installation process. In order to use Code Converter, you must first install the Cross-OS File Exchange software (File Conversion Utility, FCU), and then install Code Converter. For details on installing FCU, see the *Hitachi Cross-OS File Exchange User's Guide*.

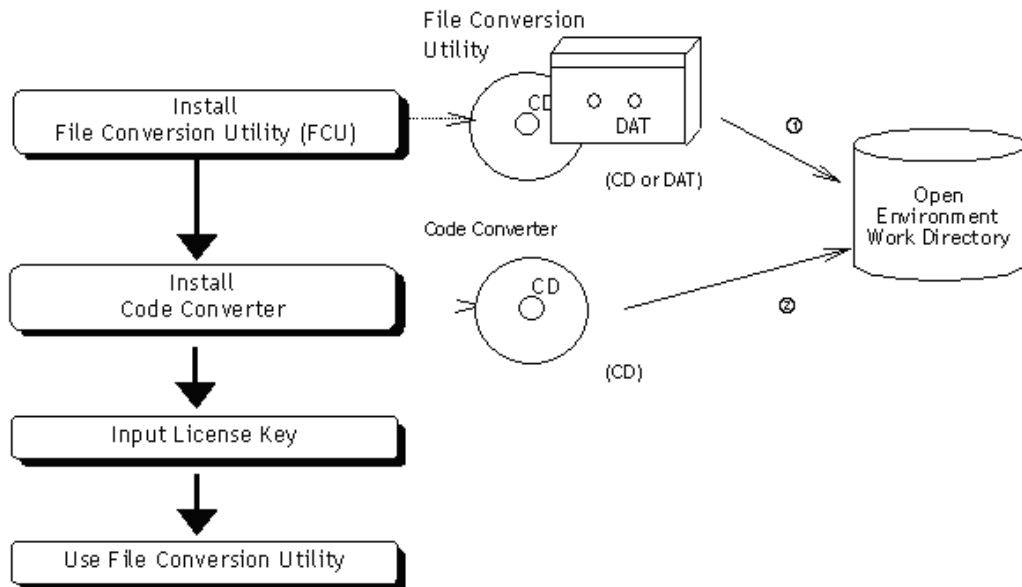

Figure 3-1 Installation Overview

Installation Media for UNIX-based Systems

Table 3-1 lists and describes the FX Code Converter Installation Utility files for use with UNIX systems. FX Code Converter provides these files in tar (tape archive) format. For information about supported operating systems, please contact your Hitachi Data Systems representative.

Table 3-1 Code Conversion Utility Files for UNIX Systems

File Name	Contents		Installation Location
libuoc.* (Note 1)	UOC double-byte conversion function's object (replace with a dummy object provided by FAL/FCU)		/usr/lib
codetran.ini	ini file used by the double-byte code conversion routine		FAL/FCU boot directory
HOSTBIG5.tbl	IBM Traditional Chineseà Big5 conversion table	standard table for mto conversion	
BIG5HOST.tbl	Big5à IBM Traditional Chinese conversion table	standard table for otm conversion	
EditOpFile	Edit Option file		
ccnv (Note 2)	Executable file for the ccnv command used to customize code conversion tables for all files contained in this table.		
ppkeyset	Executable file for inputting a license key code.		/usr/bin
libuoc.ver (Note 5)	Version information file		/usr/lib
uoc.c (Note 3)	Standard source provided	Files for creating user-defined UOC function that is used when not using Code Converter	FAL/FCU boot directory
uocerror.h (Note 3)	Standard header file provided		
libuoc.mak (Note 3)	Makefile		
uoc.exp (Notes 3, 4)	Module definition file		
<p>Notes:</p> <ol style="list-style-type: none"> 1. This file extension is used in place of ".*" depending on the platform as shown in Table 3-2. 2. Use ccnv listed here when customizing code conversion tables, such as adding user-defined characters or characters not in conversion table. 3. These files are not necessary when you use Code Converter. 4. uoc.exp is provided only in the AIX version. 5. Place libuoc.ver in /usr/lib/. 			

Table 3-2 File Extensions for UNIX-based Operating Systems

Type	Manufacturer	Operating System	File Extension
UNIX server	HP	HP-UX 11.0 or later	.sl
		HP-UX 11iV2 (IA-64) or late	.so
	IBM	AIX 5.2 or later	.a
	SUN	Solaris 8 or later	.so.1
Linux	Red Hat	Linux AS2.1 or later	.so.1
	SUSE	Linux ES9 or later	.so.1

Installation Media for Windows-based Systems

Table 3-3 lists and describes the FX Code Converter Installation Utility files for use with Windows systems. FX Code Converter provides these files in Windows install format (InstallShield). For information about supported operating system versions, please contact your Hitachi Data Systems representative.

Table 3-3 Code Conversion Utility Files for Windows Systems

File Name	Contents		Installation Location
uoc.dll	UOC double-byte conversion function's object (Replace with a dummy object provided by FAL/FCU)		FAL/FCU boot folder(C:\FCU)
codetran.ini	ini file used by the double-byte code conversion routine		
HOSTBIG5.tbl	IBM Traditional Chineseà Big5 conversion table	standard table for mto conversion	
BIG5HOST.tbl	Big5à IBM Traditional conversion table	standard table for otm conversion	
EditOpFile	Edit Option file		
ccnv.exe (Note 1)	Executable file for the ccnv command used to customize code conversion tables for all files contained in this table.		
ppkeyset.exe	Executable file for inputting a license key code.		
libuoc.ver (Note 3)	Version information file (Stored in the Windows system directory)		C:\WINDOWS
uoc.c (Note 2)	Standard source provided	File for creating user-defined UOC function that is used when not using Code Converter	FAL/FCU folder \UOC(C:\FCU\UOC)
uocerror.h (Note 2)	Standard header file provided		
uoc.mak (Note 2)	Makefile		
uoc.dsp (Note 2)	Project file		
uoc.def (Note 2)	def file		
<p>Notes:</p> <ol style="list-style-type: none"> 1. Use ccnv files listed here when customizing code conversion tables, such as adding user-defined characters or characters not in the conversion table. 2. These files are not necessary when you use Code Converter. These files are stored in the subdirectory "Uoc" that is created under the working directory of the installation directory. 3. This file is stored in a Windows system directory (e.g., c:\WINDOWS). 			

Installation and Uninstallation for UNIX Systems

This section discusses installation, uninstallation, and upgrade or downgrade of the FX Code Converter program using UNIX Systems.

Installing for UNIX Systems

To install Code Converter:

1. Log in to the open-systems server (UNIX server) as root.
2. To mount Code Converter, insert the CD into the drive.
3. Go to the working directory of the installation server, and then use the following tar command to copy all files in the installation media to the working directory. The Code Converter files listed in Table 3-1 are stored in the working directory of open systems. Enter the following, specifying the CD device file name as shown in Table 3-4.

```
#tar xvf xxxxxx/libuoc.tar
```

Table 3-4 CD Device File Names

OS	Installation Media	Device File Name
HP-UX 10.20 or later	CD	(Mount point)/PROGRAM/CONVERT/MAIN/HP_UX/
Tru64 UNIX V5.1 or later	CD	(Mount point)/PROGRAM/CONVERT/MAIN/DIGITAL/
AIX 4.3.3 or later	CD	(Mount point)/PROGRAM/CONVERT/MAIN/AIX/
Solaris 2.6 or later	CD	(Mount point)/PROGRAM/CONVERT/MAIN/SOLARIS/

Note: When you mount the CD, file names/directory names may not be displayed in all caps as shown in Table 3-4. You may also find a semicolon (;) plus one character, e.g., ';I', at the end of the file name. In these cases, you need to place single quotes around the file name. Check on the file name using the "ls" command.

4. Remove the CD for Code Converter from the drive.
5. Save libuoc.* in /user/lib under another file name. **Note:** Specify the file extension for your model according to Table 3-2.
6. Move the shared library to /usr/lib/: # mv -f libuoc.* /usr/lib
Note: Specify the file extension for your model according to Table 3-2.
7. Move the version information file to /usr/lib/:
mv -f libuoc.ver /usr/lib
Important: The FCU cannot operate unless this is done.
8. Move the inputting file for the license key to /usr/bin/:
mv -f ppkeyset /usr/bin
9. Log out, and then log in again. Code Converter is now installed.

Uninstalling for UNIX Systems

Note: Before uninstalling the FAL/FCU products, you must uninstall the Code Converter products.

To uninstall Code Converter:

1. Log in to the open-systems server (UNIX server) as root.
2. Delete all files described in Table 3-1 by using the “**rm**” command.
3. Delete the **libuoc** executable files and the version information files which have been installed on the **/usr/lib** directory. **Note:** Specify the file extension for your model according to Table 3-2.

```
# cd /usr/lib
# rm libuoc.* libuoc.ver
```

4. Rename the file that was saved under another file name at the installation procedure in [Installing for UNIX Systems](#) (step 5) to **libuoc.***. The FCU cannot operate unless this is done. Specify the file extension for your model according to Table 3-2.

Upgrading or Downgrading

To upgrade or downgrade Code Converter:

1. Log in to the open-systems server (UNIX server) as root.
2. Copy the files within the related files that are provided by Code Converter, if a user has changed, into a working directory.
3. Edit the option file (EditOpFile).
4. Install Code Converter from CD.
5. Restore the files from step 2.
6. Log out, and then log in again.

Code Converter is now upgraded/downgraded.

Installation and Uninstallation for Windows Systems

This section discusses installation, uninstallation, and upgrade or downgrade of the FX Code Converter program on Windows systems.

Installing for Windows Systems

To install Code Converter:

1. Start the computer.
2. Log in as administrator.
3. Insert the CD for Code Converter into the drive.
4. Double-click "**setup.exe**" on Explorer to run the Code Converter setup file:
 "**setup.exe**" is in the following directory:
 (CD drive)\PROGRAM\CONVERT\MAIN\WIN\DISK1.
5. Follow the instructions displayed and enter **/select user information, installation folder, program folder**, etc. Specify the same FCU directory as the destination directory.
6. When the "**InstallShield Wizard Complete**" window appears, click the **[Finish]** button to complete the Code Converter installation.

Uninstalling for Windows Systems

Note: Before uninstalling the FAL/FCU products, you must uninstall the Code Converter products.

To uninstall Code Converter:

1. Start the computer.
2. Log in as administrator.
3. Select **[Start]-[Settings]-[Control Panel]**.
4. Double-click **[Add/Remove Programs]**.
5. Select **[Code Converter]** from the list under **[Removes the Change or Remove Programs]**, and click the **[Change/Remove]** button to start uninstallation. Follow the instructions displayed.
6. When the "**Maintenance Complete**" window appears, click the **[Finish]** button to complete the uninstallation process.

Upgrading and Downgrading

To upgrade or downgrade Code Converter:

1. Start the computer.
2. Log in as administrator.
3. Copy files within the related files that are provided by Code Converter, if a user has changed, in a working directory.
4. Edit the option file (EditOpFile).
5. Install Code Converter from CD.
6. Restore files from step 3 above.

License Key Input

A license key is required for using the FX Code Converter.

License Key for UNIX Systems

Input the license key using the **ppkeyset** command. **Note: When you use** the AIX operating system, and you run the Code Converter program before inputting a license key, an error may occur during the **ppkeyset** command execution. Enter the **slibclean** command, and input the license key using the **ppkeyset** command.

Input the following commands from the command line, appropriate to each operating system and platform:

- **HP-UX:** ppkeyset <License key> /usr/lib/libuoc.sl
- **Solaris:** ppkeyset <License key> /usr/lib/libuoc.so.1
- **AIX:** ppkeyset <License key> /usr/lib/libuoc.a
- **Tru64 UNIX:** ppkeyset <License key> /usr/lib/libuoc.so

License Key for Windows Systems

1. Double click the "ppkeyset.exe" of install directory. The following message will appear in MS-DOS window:
"Please enter <License key> [**Installed Directory or File**]... or <**quit**> for exit"
2. Enter <license key> < Installed Directory>
3. Enter the following , if < **Installed Directory**> is a directory name with "space":
<license key> fal.dll falmt.dll
The following message will appear:
"Please enter <License key> [**Installed Directory or File**]... or <**quit**> for exit"
4. Enter "**quit**".

Using FX Code Converter

This chapter describes the operational sequence, how users perform operations and use the functions of Code Converter.

- [FX Code Converter User Process Flow](#)
- [Database Data File Record Format](#)

FX Code Converter User Process Flow

Figure 4-1 illustrates the process flow for the FX Code Converter.

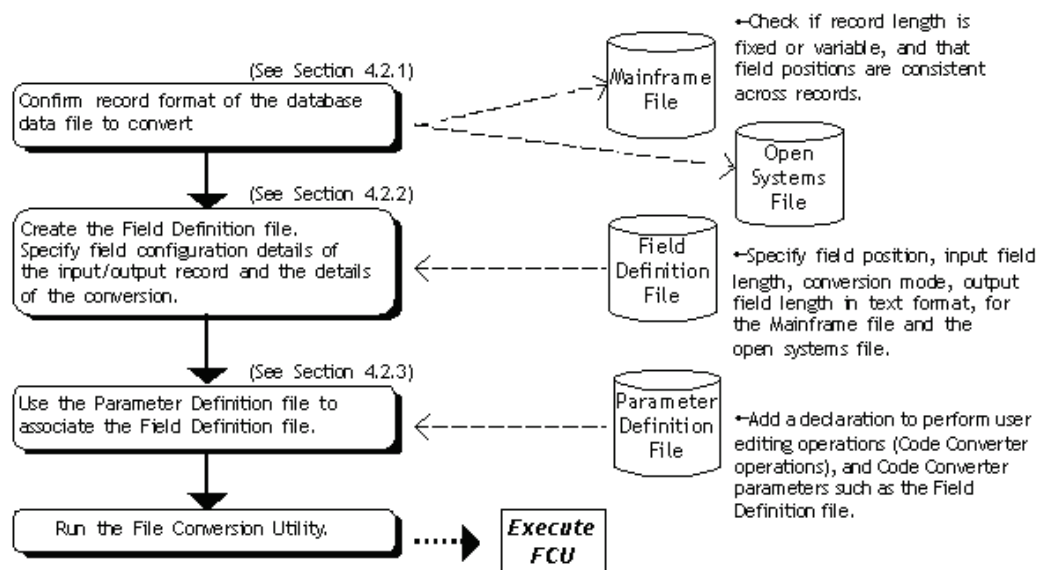

Figure 4-1 FX Code Converter User Process Flow

Code Converter process flow:

1. Confirm the record formats of the database data file to be converted.

Note: When using Code Converter to perform double-byte conversions, the database data file must be a sequential access method file (SAM) with fixed-length or variable-length records. Additionally, the field positions within the records must be fixed and consistent.

Confirm the record formats of the mainframe file and open-systems file.

2. Create a Field Definition file. Specify the field configuration details of the input/output record and the details of the conversion:
 - The position of the fields to be converted, the type of conversion to be performed on those fields, how the result should be edited and output to the output record, and the length of the output field are specified.
 - A Field Definition file is created for each record format (field configuration) found in the database data file to be converted. For each field in the input record, position, length, type of code conversion to be performed, and output length are specified in the prescribed format.
3. Use the Parameter Definition file to associate the Field Definition file.

- Parameter Definition files are used to associate Field Definition files with the database data file to be converted. The Parameter Definition file is used by the File Conversion Utility to specify the database data files for mto conversion or otm conversion (a pair of mainframe SAM file and open-systems UNIX/PC file).
 - Describe the Parameter Definition file in text file form.
4. Execute/run the File Conversion Utility.

Database Data File Record Format

When using Code Converter to perform conversions such as double-byte conversions, the database data file must be a sequential access method file (SAM) with fixed-length or variable-length records. In addition, the field positions within the records must be fixed and consistent. You must confirm the record formats of the mainframe file and the open-systems file.

Code Converter retrieves input data from a fixed position for each record. The field position within the record and the field length must be the same for all records, as shown in Figure 4-2 and Figure 4-3 (e.g., SAM file output by the DB2 REORG utility).

	control information (6Byte)	binary (4Byte)	Zone data (8Byte)	alphanumeric character (40Byte)	double byte character (20Byte)	packed decimal (6Byte)
Record1	X'00006B000301'	X'80000001'	00000001	ABCDEFGF **	日立	X'F00000000001'
Record2	X'00006B000302'	X'80000002'	00000002	BCDEFGH **	中国	X'F00000000002'
Record3	X'00006B000303'	X'80000003'	00000003	CDEFGHI **	日本	X'F00000000003'
Record4	X'00006B000304'	X'80000004'	00000004	DEFGHIJ **	韩国	X'F00000000004'

Figure 4-2 Field Position and Field Length Example 1

	control information (6Byte)	binary (4Byte)	Zone data (8Byte)	alphanumeric character (40Byte)	double byte character (20Byte)	packed decimal (6Byte)
Record1	X'00006B000301'	X'80000001'	00000001	ABCDEFGF **	日立	
Record2	X'00006B000302'	X'80000002'				
Record3	X'00006B000303'	X'80000003'	00000003	CDEFGHI **	日本	X'F00000000003'
Record4	X'00006B000304'	X'80000004'	00000004			

Figure 4-3 Field Position and Field Length Example 2

Figure 4-4 illustrates the record formats supported and conversion modes provided by the FX Code Converter.

conversion	Mainframe record	convert	UNIX/PC record	Refer to
mto	fixed-length record	→	fixed-length record	(1)
	variable-length record	→	variable-length record	(2)(a)
otm	fixed-length record	←	fixed-length record	(1)
	variable-length record	←	variable-length record	(2)(b)
	fixed-length record	←	variable-length record	(2)(c)

Figure 4-4 Record Form and Code Conversion Form Conversion

Code Conversion Using Fixed-Length Records

Figure 4-5 shows the mto (mainframe-to-open) and otm (open-to-mainframe) code conversion when mainframe records and open-systems records both have fixed-length formats.

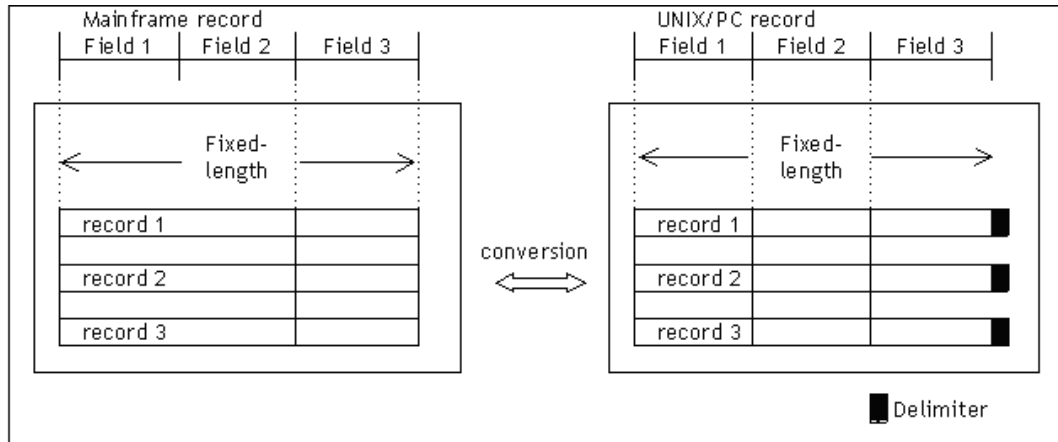

Figure 4-5 Code Conversion Outline for Fixed-length Records

Code Conversion Using Variable-Length Records

The following actions must be performed when converting variable-length records:

1. Specify all delimiters.
2. Ensure that the total of field lengths specified in the Field Definition file equals the maximum record length of the mainframe record length – (minus) 4.
3. Ensure that the fields specified in the Field Definition file end within the mainframe record.

Note: When the last field has a variable length ("end" is specified for input field length), numeric conversion cannot be performed on the field. Numeric codes (packed decimal/zoned decimal) are treated as being in fixed-length fields.

Converting Variable Length Mainframe Records to Variable Length UNIX/PC Records (mto)

Code conversion is performed on each field in the variable-length mainframe record, and the result is output as a variable-length UNIX/PC record.

Note: Make sure to specify a delimiter in the end statement of the Field Definition file.

- **Fixed field length:** Figure 4-6 shows how mto code conversion is performed when the fields specified in the field definition statement have a fixed length (when “end” is not specified for the input field length). The record length of variable-length mainframe records must be short as the maximum record length – (minus) 4.

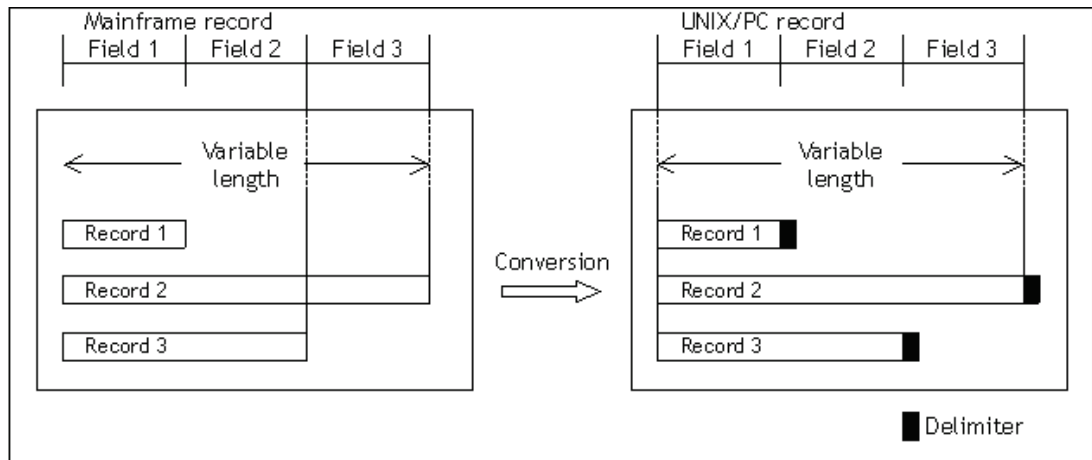

Figure 4-6 Code Conversion in Variable Length Records (“end” not specified for field length)

- Record 1: Code conversion is performed on Field 1 only. Fields 2 and 3 are not processed.
 - Record 2: Code conversion is performed on Fields 1 through 3.
 - Record 3: Code conversion is performed on Fields 1 and 2. Field 3 is not processed.
- **Last field = variable length:** Figure 4-7 shows how otm (open-systems-to-mainframe) code conversion is performed, when the last field specified in the field definition statement has a variable length (when “end” is specified for the input field length). The record length of variable-length mainframe records must be short as the maximum record length - 4.

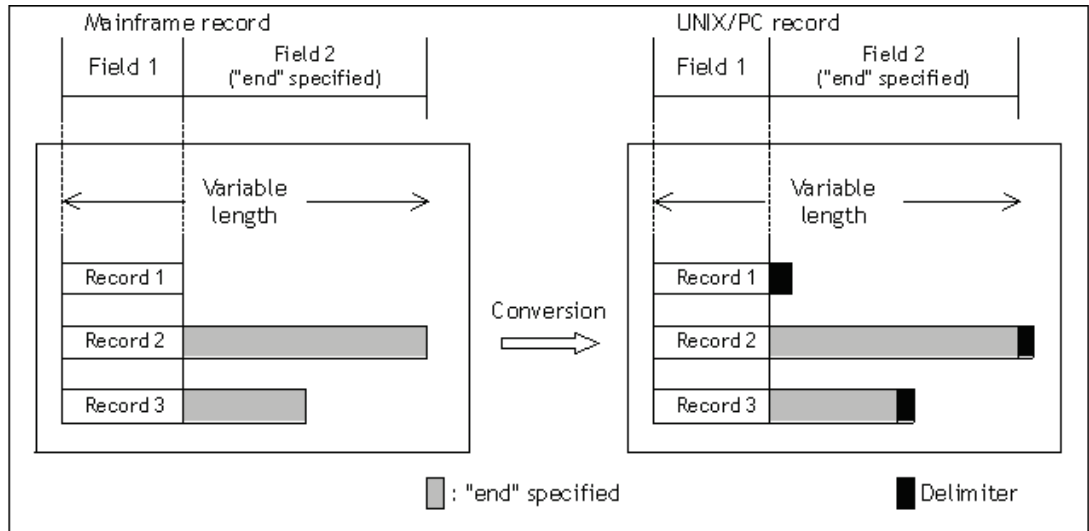

Figure 4-7 Code Conversion in Variable Length Records (with "end" specified for field length)

- You can specify "end" in the field definition statement only when the field is the last field of the record. When "end" is specified, code conversion for the last field starts at the beginning of the field and ends at the end of the record. In Figure 4-7 "end" is specified for Field 2, indicated by the grey areas.

Converting Variable-Length UNIX/PC Records to Variable-Length Mainframe Records (otm)

After removing the delimiters in the variable-length UNIX/PC records, code conversion is performed on each field, and the result is output to the mainframe in variable-length record format. The output record length after conversion must equal to (the maximum record length defined for the mainframe record - 4).

- **Fixed field length:** Figure 4-8 shows how otm code conversion is performed when the fields specified in the Field Definition file have a fixed length (when "end" is not specified for the input field length). Delimiters are not output to the mainframe records. The record length of variable-length mainframe records must be as short as the maximum record length - 4.

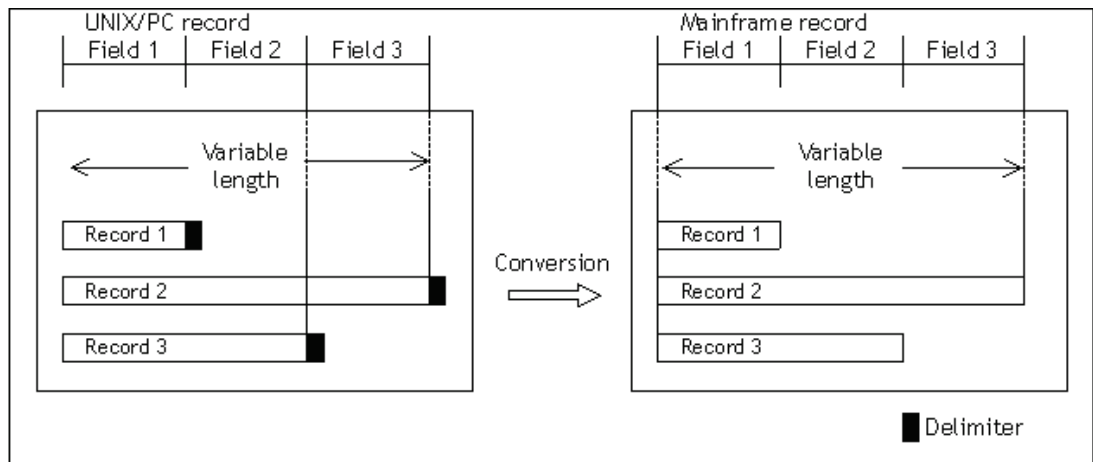

Figure 4-8 Overview of Code Conversion in Variable Length Records ("end" not specified for field length)

- Record 1: Code conversion is performed on Field 1 only. Fields 2 and 3 are not processed.
- Record 2: Code conversion is performed on Fields 1 through 3.
- Record 3: Code conversion is performed on Fields 1 and 2. Field 3 is not processed.
- **Last field = variable length:** Figure 4-9 shows how otm (open-systems-to-mainframe) code conversion is performed, when the last field specified in the Field Definition file has a variable length (when "end" is specified for the input field length).

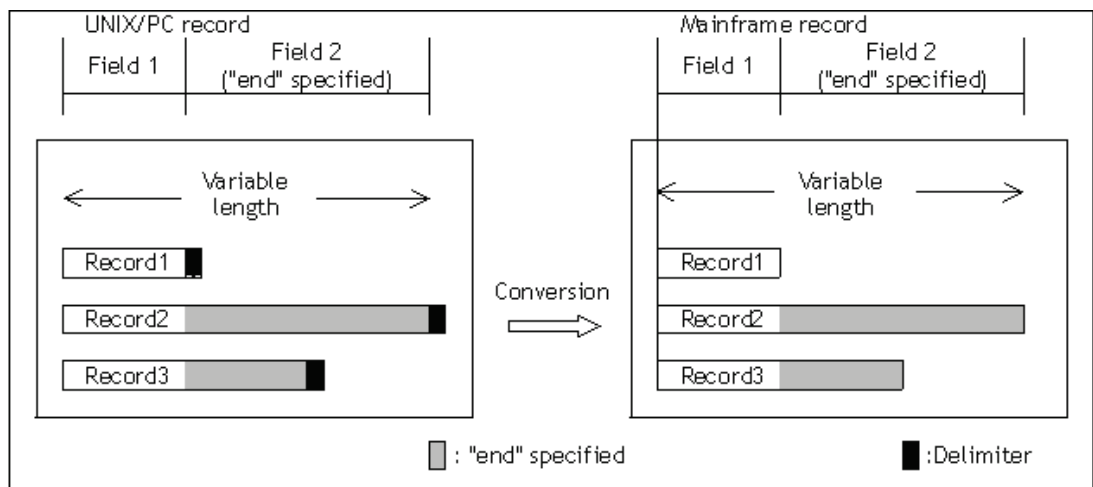

Figure 4-9 Overview of Code Conversion in Variable Length Records (with "end" specified for field length)

- You can specify "end" in the Field Definition file only when the field is the last field of the record. When "end" is specified, code conversion for the last field starts at the beginning of the field and ends at the end of the record. In Figure 4-9, "end" is specified for Field 2, indicated by the grey areas.

Converting Variable Length UNIX/PC Records to Fixed Length Mainframe Records (otm)

After removing the delimiters in the variable-length UNIX/PC records, code conversion is performed on each field, and the result is output to the mainframe in fixed-length record format.

Padding and delimiter must be specified in the end statement of the Field Definition file.

After code conversion, the extra space in the mainframe record is padded with padding code specified. The extra space in each field is filled with the field padding code specified in the Edit Option file. The total length of output fields defined in the field definition must be less than the fixed length of the mainframe record.

Note: Mainframe records with padding cannot be reconverted to UNIX/PC records using mto conversion.

- **Fixed field length:** Figure 4-10 shows how otm code conversion is performed when the fields specified in the field definition statement have a fixed length (when "end" is not specified for the input field length). Delimiters are not output to the mainframe records.

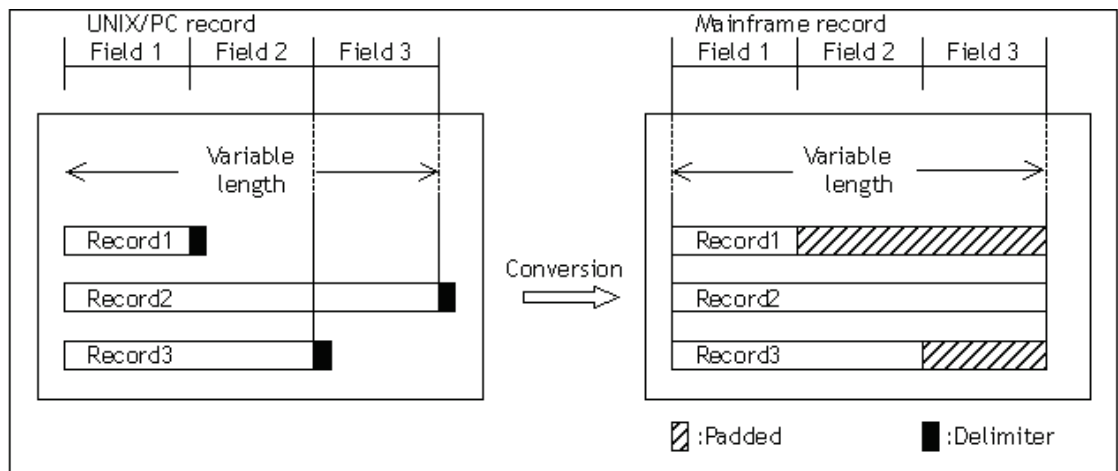

Figure 4-10 Overview of Code Conversion in Variable Length Records ("end" not specified for field length)

- Record 1: Code conversion is performed on Field 1 only. The rest of the mainframe record is padded with a padding code. Fields 2 and 3 are not processed.

- Record 2: Code conversion is performed on Fields 1 through 3.
- Record 3: Code conversion is performed on Fields 1 and 2. The rest of the mainframe record is padded with a padding code. Field 3 is not processed.
- **Last field = variable length:** Figure 4-11 shows how otm (open-systems-to-mainframe) code conversion is performed, when the last field specified in the Field Definition file has a variable length (when “end” is specified for the input field length).

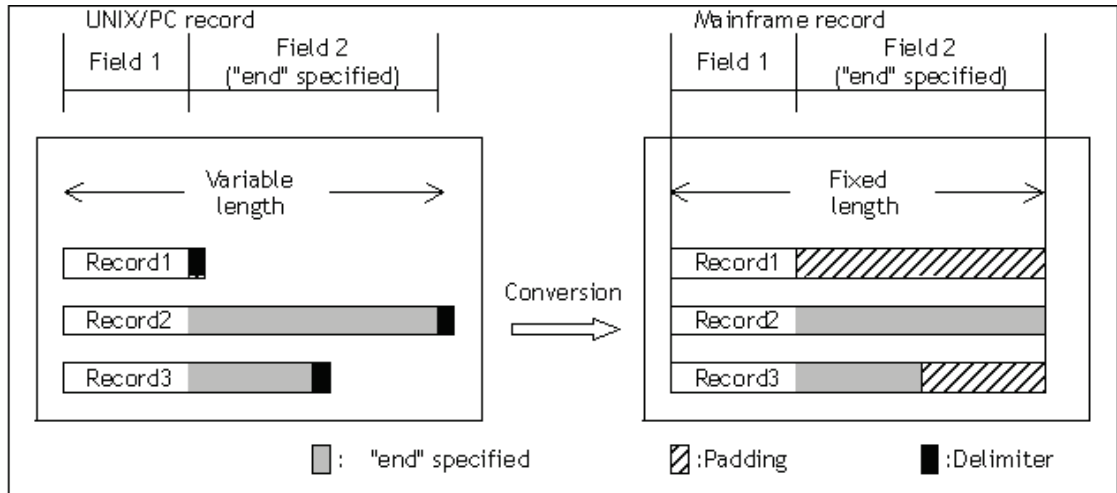

Figure 4-11 Overview of Code Conversion in Variable Length Records (with “end” specified for field length)

- Record 1: Code conversion is performed on Field 1 only. The rest of the mainframe record is padded with a padding code. Field 2 is not processed.
- Record 2: Code conversion is performed on Fields 1 and 2.
- Record 3: Code conversion is performed on Fields 1 and 2. The rest of the mainframe record is padded with a padding code.

Creating a Field Definition File

Create a Field Definition file to specify the position of the fields to be converted, the type of conversion to be performed on those fields, how the result should be edited and output to the output record, and the length of the output field.

A Field Definition file is created for each record format (field configuration) found in the database data file to be converted. For each field in the input record, specify its position, length, type of code conversion to be performed, and output length, in the format described below.

Use editors such as "vi" to create the Field Definition file as a text file. The maximum file size is 1,000 lines, including comments. To use the file, store it in the current directory of the open systems (UNIX/PC server).

The Field Definition file consists of field definition statements, an end statement, and comments.

Field Definition Statement

Specify a line of field definition statement for each field in the input record in the order they appear, starting from the first field of the record (Figure 4-12).

```
fld Δ relative_byte_position Δ input_field_length Δ field_attribute Δ [output_field_length]
```

Δ : indicates one or more bytes of space

[] : indicates optional parameter

Figure 4-12 Field Definition Statement

- **fld:** Keyword (reserved word) to indicate a field definition statement.
- **relative_byte_position:** Specify a relative byte position within the record to indicate where the field begins, using a decimal value starting from 0.
- **input_field_length:** Specify the byte length of the input (source) field using a decimal value.
- **field_attribute:** Specify the type of code conversion to be performed on the field as follows:
 - Suppress output : SKIP
 - No code conversion: NOP
 - Alphanumeric character conversion: CHAR:OPnn (for OPnn, see Figure 4-4).
 - Double-byte character conversion: KANJI:OPnn (for OPnn, see Figure 4-4).
 - Numeric conversion: NUM:OPnn (for OPnn, see Table 4-5)

- **output_field_length:** Specify the byte length of the field's output (target) area, using a decimal value. This parameter can be omitted if the length is the same as the byte length of the input field. **Note:** This parameter must be omitted for fields with no code conversion and fields that suppress output.

If the field is the last field in the record, and if the rest of the record is included in this last input field, the byte length of the input field can be specified with "end" as shown below. Since you do not need to specify a specific value, this allows you to create a field definition statement/Field Definition file for multiple datasets/records that is the same except the length of the last field (see Figure 4-13).

```
fld Δrelative_byte_position Δ end Δ field_attribute Δ [output_field_length]
Δ : indicates one or more bytes of space
[] : indicates optional parameter
```

Figure 4-13 Last Field In The Record

- **end:** the rest of the record from where this field begins is defined as an input field. The field length depends on the record format, as follows:
 - Fixed-length record: (byte length of input field) = (input record length) - (relative byte position within the record)
 - Variable-length record: (byte length of input field) = (the length after code conversion)

Note: You cannot perform numeric conversion on a variable-length record field with "end" specified. Numeric conversion can only be performed on fixed-length records.

End Statement

A line of end statement is written at the end, after field definition statements are specified for all fields in the input record (Figure 4-14).

```
end Δ [Delimiter=delimiter_code][,Padding=padding_code]
Δ : indicates one or more bytes of space
[] : indicates optional parameter
```

Figure 4-14 End Statement

- **end:** Keyword (reserved word) to indicate that all Field definition statements have been written.
- **Delimiter=delimiter_code:** Specify a delimiter code as follows, if a delimiter is added to the end of the open-systems records:

- To add CR=(0D) - Delimiter=CR
- To add LF=(0A) - Delimiter=LF
- To add CRLF=(0D0A) - Delimiter=CRLF (only for Windows)
- **Padding=padding_code:** When converting variable-length open-systems records to fixed-length mainframe records, specify a padding code with a 2-digit hexadecimal character, to fill the space between the last field to convert and the end of the mainframe record.

Note: When adding a delimiter, the output record length increases/decreases accordingly.

Take this into consideration when specifying the output length. Note that when the input record contains binary data in addition to single-byte and/or double-byte characters, the binary data may have data that matches the delimiter specified. This may prevent correct recognition of delimiters to isolate records.

Comments

Comments can be included as necessary, within a field definition statement (at the end of the statement), or separately as a comment statement (Figure 4-15). Table 4-1 indicates the tables that show the conversion mode parameters for each field attribute.

- When including a comment within a field definition statement, add the comment after the required items of the statement (5 parameters).
- When the byte length of the output field is omitted, “#” can be specified in its place to indicate that subsequent data is a comment.
- When “#” is specified at the beginning of a line, the entire line becomes a comment.
- Blank lines are also treated as comments.

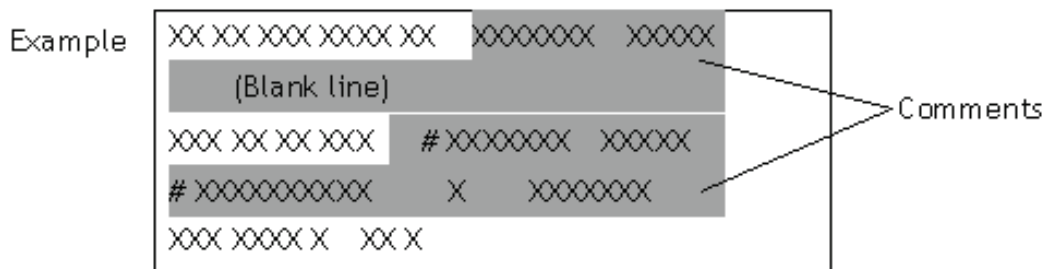

Figure 4-15 Including Comments in a Field Definition File

Table 4-1 Conversion Mode Parameters by Type of Conversion and Field Attribute

Type of conversion	Field attribute	OPnn table
Suppress output	SKIP	-
No code conversion	NOP	-
Alphanumeric character conversion	CHAR:OPnn	Table 4-2
Double-byte character conversion	KANJI:OPnn	
Numeric conversion	NUM:OPnn	Table 4-3
Suppress output	SKIP	-

Conversion Modes For Open Systems Using Big5

Table 4-2 lists the attribute options for use with the IBM Traditional Chinese Code System.

Table 4-2 Field Attribute Options for the IBM Traditional Chinese Code System

Open System (Double Byte Code Big5) (Single Byte Code ASCII)		Conversion mode parameter	
		mto conversion	otm conversion
Mainframe (Double byte: IBM Traditional Chinese) (Single byte: EBCDIC)	Double Byte Only	KANJI:OPK1	KANJI:OPK6
	Double Byte and Single Byte	KANJI:OPK2	KANJI:OPK7
Alphanumeric character conversion	Single Byte only	CHAR:OPK4	CHAR:OPK9

Indication Parameter Of Conversion Mode When Field Is Value

Table 4-3 lists the field attribute options for the numeric-based coding scheme.

Table 4-3 List of Field Attribute Options for Numeric-based Coding Scheme

Open System (character data)		Conversion mode parameter	
		mto conversion	otm conversion
Mainframe (Packed decimal data) (Zoned decimal data)	Packed decimal	NUM:OPA1	NUM:OPA6
	Zoned decimal	NUM:OPA2	NUM:OPA7

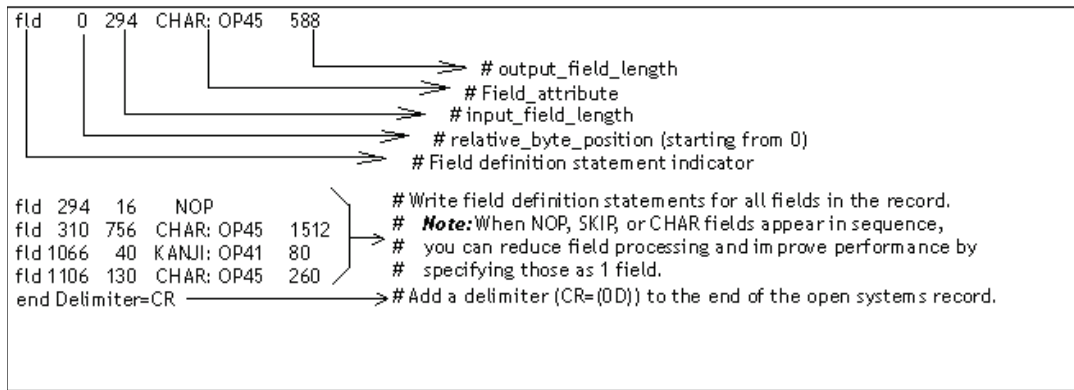

Figure 4-16 Example of a Field Definition File

In the example in Figure 4-16 the input record length is $294 + 16 + 756 + 40 + 130 = 1,236$ bytes and the output record length is $588 + 16 + 1,512 + 80 + 260 = 2,456$ plus 1 byte for delimiter, thus 2,457 bytes.

- The **first** field contains the first 294 bytes of data. Single-byte alphanumeric character conversion is performed before output. Conversion is performed according to conversion mode information for [CHAR:OP45] specified in the Edit Option file. The output field length is 588 bytes.
- The **second** field is the 16 bytes of data that follow the first field. No code conversion is performed, and data is output without any change. The output field length is 16 bytes.
- The **third** field is the 756 bytes of data that follow the second field. Single-byte alphanumeric character conversion is performed before output. Conversion is performed according to conversion mode information for [CHAR:OP45] specified in the Edit Option file. The output field length is 1512 bytes.
- The **fourth** field is the 40 bytes of data that follow the third field. Only double-byte code conversion is performed before output. Conversion is performed according to conversion mode information for [KANJI:OP41] specified in the Edit Option file. The output field length is 80 bytes.
- The **fifth** field is the 130 bytes of data that follow the fourth field. Single-byte alphanumeric character conversion is performed before output. Conversion is performed according to conversion mode information for [CHAR:OP45] specified in the Edit Option file. The output field length is 260 bytes.

Using the Parameter Definition File to Associate Field Definition Files

Parameter Definition files are used to associate Field Definition files with the database data file to be converted. The Parameter Definition file is used by the File Conversion Utility to specify the database data files for mto conversion or otm conversion (a pair of mainframe SAM file and open-systems UNIX/PC file).

Add a declaration to perform user editing operations (Code Converter operations), as well as Code Converter parameters such as the Field Definition file, to the Parameter Definition file. The Parameter Definition file is also created by the user as a text file, following a prescribed format.

Adding Parameters to the Parameter Definition File

Add two parameters as follows:

- **USER-EDIT:** This is a reserved keyword declaring that user editing operations (Code Converter operations) are to be performed. At the end of the existing Parameter Definition file, enter one or more single-byte spaces, and then specify this keyword exactly as shown.
- **Field Definition file name and Edit Option file name:** These are the Code Converter parameters. Add `./` to the name of the Field Definition file created as described in section 4.2.2 and to the name of the Edit Option file (EditOpFile), join the two names with a `,` (comma), then add this after USER-EDIT in following one or more single-byte spaces. Do not enter any spaces between the Field definition file name and the Edit Option file name.

Figure 4-17 shows the parameter definition file being used to associate the field definition file.

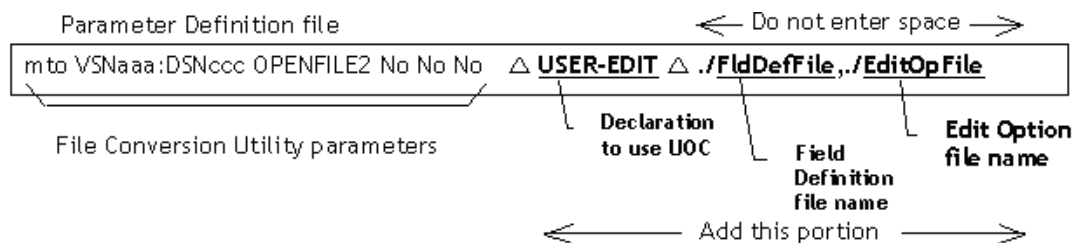

Figure 4-17 Using the Parameter Definition File to Associate the Field Definition File

Edit Option File

The Edit Option File defines the details for all the code conversion modes supported by Code Converter (Table 4-2, Table 4-3). It is located on the current directory of the open-systems environment (UNIX/PC server).

Users may want to customize this file, such as changing the space code used for replacing the undefined character code to a special code. For this reason, a brief explanation of what is defined in the Edit Option file is presented in Figure 4-18.

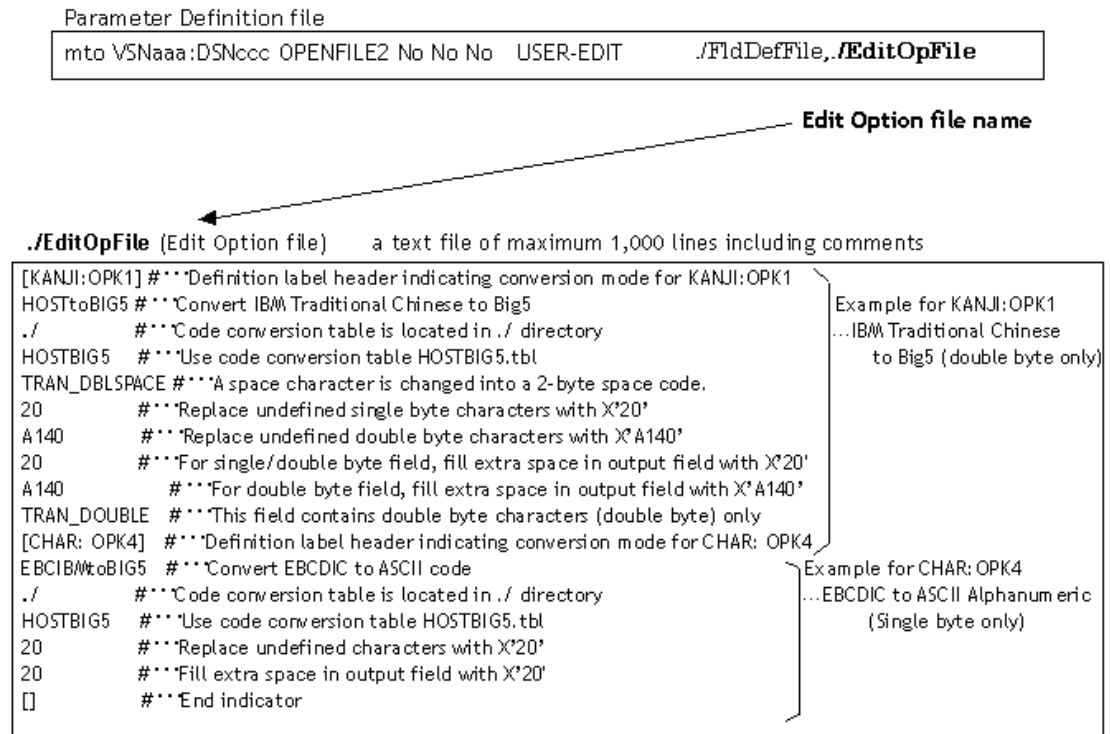

Figure 4-18 Specifying Conversion Mode in the Edit Option File

For each line in the Edit Option file, the part of the line after the necessary item (1 parameter), as well as any data following "#", are treated as comments. Blank lines are also treated as comments.

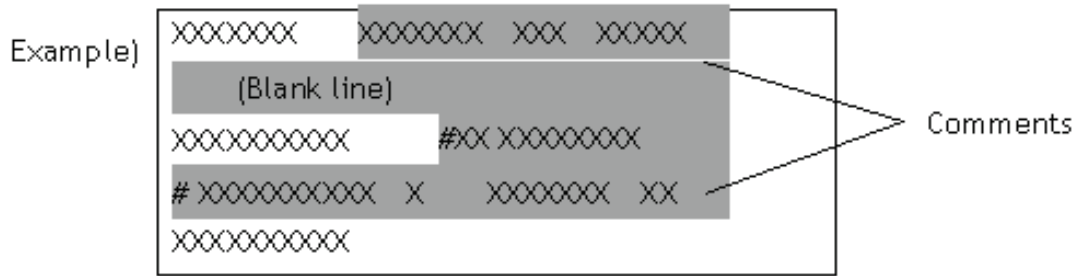

Figure 4-19 Including Comments in the Edit Option File

Conversion Mode Format Details

- The Edit Option file includes conversion mode information such as those for alphanumeric character conversions and double-byte code conversions. Information appears in no particular order for every conversion mode (OPnn) used in the Field Definition file.
- Information for each conversion mode starts with a definition label header specified in the format “[CHAR:OPnn]”, “[KANJI:OPnn]”, or “[NUM:OPnn]”, and continues until the next definition label header “[xxxx:OPnn]” appears. The end of information is indicated with the end indicator (two characters “[]”).
- Conversion mode parameters are specified one parameter per line, for the prescribed number of parameters as shown in Table 4-4 through Table 4-6. Parameters are specified in the order of the line number shown in these tables. Note these line numbers only count lines with effective information, and do not include lines that only contain comments.
- The last line contains the end indicator (“[]”), which indicates the end of the Edit Option file.

Table 4-4, Table 4-5, and Table 4-6 list the conversion mode parameters used by the FX Code Converter.

Table 4-4 Conversion Mode Parameters for Alphanumeric Character Conversion “[CHAR:OPnn]” (number of parameters: 6)

Conversion Mode Parameter		Parameter value	Description
Type of code conversion	mto	EBCIBMtoBIG5	Convert IBM EBCDIC to ASCII
	otm	BIG5toEBCIBM	Convert ASCII to IBM EBCDIC
Tables directory		Alphanumeric string	Specifies where the code conversion tables are located.
Conversion table name		Alphanumeric string	Specifies the code conversion table to use for this field.
Replace code for undefined characters		2-digit hexadecimal character	Specifies the code to replace undefined characters.
Field padding code		2-digit hexadecimal character	Specifies the code to fill the extra space in output field.
Code conversion option		Code conversion option	Allows 0-byte length records for datasets with variable-length records in mto conversion. Allows 0-byte length records in otm conversion. This line can be omitted when not specifying TRAN_NOREC.

Table 4-5 Conversion Mode Parameters for Double-Byte Code Conversion “[KANJI:OPnn]” (number of parameters: 9)

Conversion Mode Parameter		Parameter Value	Description
Type of code conversion	mtm	HOSTtoBIG5	Convert double-byte characters from IBM Traditional Chinese character to Big5
	otm	BIG5toHOST	Convert double-byte characters from Big5 to IBM Traditional Chinese character
Tables directory		Alphanumeric string	Specifies where the code conversion tables are located.
Conversion table name		Alphanumeric string	Specifies the code conversion table to use for this field.
Code conversion option		TRAN_EBCDIC	Single-byte code in the record
		TRAN_SGLSPACE	Convert spaces to single-byte space code
		TRAN_DBLSPACE	Convert spaces to double-byte space code
		TRAN_START_SINGLE	This record starts with a single-byte character*
		TRAN_START_DOUBLE	This record starts with a double-byte character*
		TRAN_SHIFT_NO	Do not insert shift code
		TRAN_SHIFT_SPACE	In otm conversion, add shift code to single-byte spaces within double-byte character strings
		TRAN_SHIFT_DBLCHAR	In otm conversion, add shift code to double-byte character strings. (Specifies double-byte and single-byte mixture)
		TRAN_NOREC	Allows 0-byte length records for datasets with variable-length records in mtm conversion. Allows 0-byte length records in otm conversion.
TRAN_NOPAD		Do not fill in field padding code for deleted SO/SI codes	
Replace code for undefined single-byte characters		Replace code for undefined single-byte characters	Replace code for undefined single-byte characters
Replace code for undefined double-byte characters		4-digit hexadecimal character	Specifies the code to replace undefined double-byte characters.
Specifies the code to replace undefined double-byte characters.		2-digit hexadecimal character	Specifies the code to fill the extra space in output field when both single-byte and double-byte codes exist.
Double-byte field padding code		4-digit hexadecimal character	Specifies the code to fill the extra space in output field when only double-byte codes exist.
Single-byte/double-byte		TRAN_DOUBLE	This field contains double-byte codes only.
		TRAN_MIX	This field contains both single and double-byte codes.

**Table 4-6 Conversion Mode Parameters for Numeric Conversion
“[NUM:OPnn]” (number of parameters: 7)**

Conversion Mode Parameter		Parameter value	Description
Type of code conversion	mto	PACKtoCHAR	Convert packed decimals to characters
		ZONEtoCHAR	Convert zoned decimals to characters
	otm	CHARtoPACK	Convert characters to packed decimals
		CHARtoZONE	Convert characters to zoned decimals
Sign position		TRAN_SIGN_F	Leading sign
		TRAN_SIGN_E	Trailing sign
		TRAN_SIGN_V	Insert sign before effective digits(only applicable to zero suppressed fields)
		TRAN_SIGN_NON	Unsigned
Decimal digits		1-digit decimal character	Specifies the number of decimal digits between 0 and 9
Zero suppression		TRAN_NON_SUPPRESS	Does not perform zero suppression
		TRAN_ZERO_SUPPRESS	Performs zero suppression
Type of plus sign*		TRAN_SIGN_PLUS_C	Indicated with C (otm conversion only)
		TRAN_SIGN_PLUS_A	Indicated with A (otm conversion only)
		TRAN_SIGN_PLUS_E	Indicated with E (otm conversion only)
		TRAN_SIGN_PLUS_F	Indicated with F (otm conversion only)
Type of minus sign*		TRAN_SIGN_MINUS_D	Indicated with D (otm conversion only)
		TRAN_SIGN_MINUS_B	Indicated with B (otm conversion only)
All-space fields		TRAN_ALLSPACE_NORMAL	In otm conversion, a field that only contains spaces generates an error. In mto conversion, fields that only contains 0 outputs a 0
		TRAN_ALLSPACE_ZERO	In otm conversion, fields that only contains spaces outputs a 0
* Parameter applicable to otm conversion. In mto conversion, signs are determined automatically.			

Mainframe-to-Open System Character Code Conversion

This chapter describes the mto character code conversion process.

- .. [Overview of Character Code Conversion](#)
- .. [Alphanumeric Field conversion \(CHAR:OPK4\)](#)
- .. [Double-byte Character Field Conversion \(KANJI:OPK1\)](#)
- .. [Double Byte Character Field Conversion \(KANJI:OPK2\)](#)
- .. [Customizing the Code Conversion Table](#)

Overview of Character Code Conversion

The single-byte code conversion process changes code from EBCDIC to ASCII. The double-byte code conversion process is from IBM Traditional Chinese to Big5.

Code Converter provides the following types of character code conversion for each field data type, as shown in Table 5-1.

Table 5-1 Code Conversion Data Types and Field Types

Input field data type	Character code conversion	Field type and conversion mode
EBCDIC	EBCDIC to ASCII	CHAR:OPK4
IBM Traditional Chinese	IBM Traditional Chinese to Big5	KANJI:OPK1
EBCDIC and IBM Traditional Chinese	EBCDIC and IBM Traditional Chinese mixture data to ASCII and Big5 code conversion	KANJI:OPK2

All code conversion uses the above code conversion tables. IBM Traditional Chinese code is converted to Big5 code type.

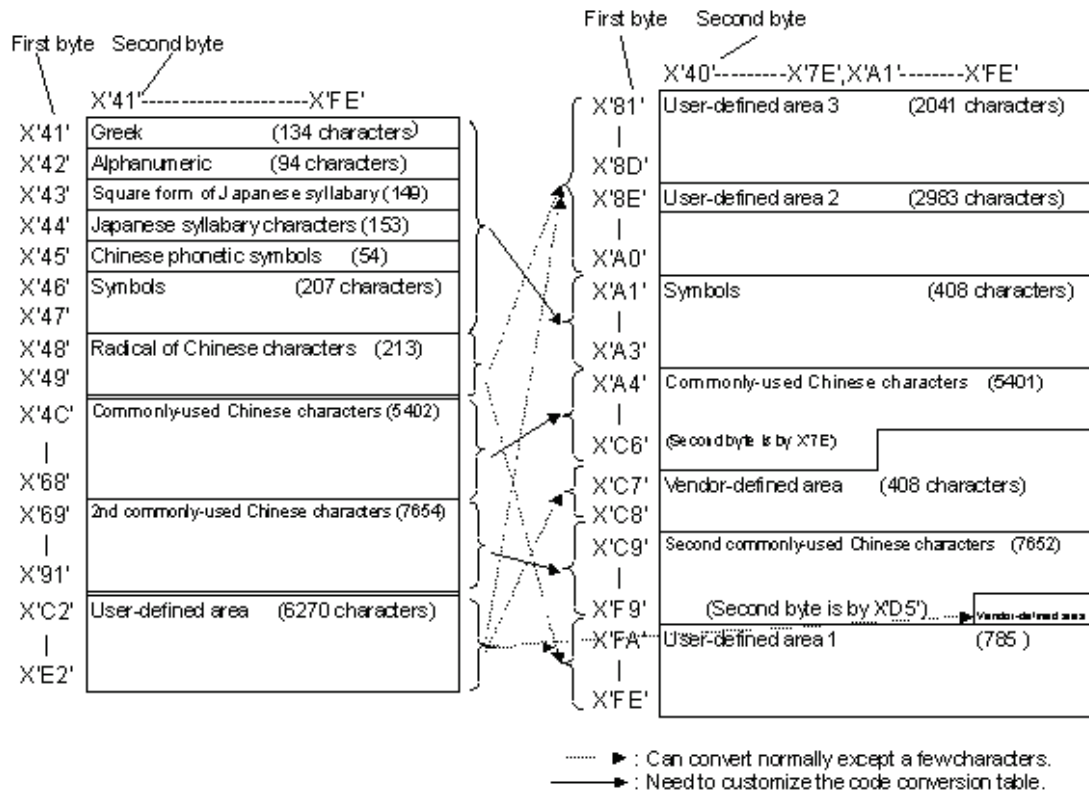

Figure 5-1 Converting IBM Traditional Chinese Code to BIG5 Code

Alphanumeric Field conversion (CHAR:OPK4)

All specified field data convert assume single-byte code. Code conversion follows the code conversion table shown in Appendix C. The following are exceptions:

- **Undefined character:** An undefined character (valid character is not defined in the conversion table) will be replaced by X'FF'. Undefined characters can be replaced by a single-byte character if it is so specified in the Edit Option file.
- **Shift code:** Shift code (X'0E': double-byte code start, X'0F': single-byte start) is treated the same way as an undefined character.

Double-byte Character Field Conversion (KANJI:OPK1)

All data conversion operations assume double-byte code. The following are exceptions:

- **Undefined character:** An undefined character (valid character is not defined in the conversion table) conversion will be replaced by **X'FFFF'**. An undefined character can be replaced by a double-byte character if it is so specified in the Edit Option file.
- **Unjustified character:** An unjustified character (first byte : **X'41'** through **X'49'**, **X'4C'** through **X'91'**, **X'C2'** through **X'E2'** second byte : **X'40'** through **X'FD'**) is treated same way as an undefined character. The space character (**X'40'**) is excluded.
- **Shift code:** The shift character (**X'0E'**: double-byte code start, **X'0F'**: single-byte code start) is treated as a double-byte code. When performing code conversion with double-byte data following a shift code and another shift code, the data is treated as an unjustified character code.
- **Space character:** An even-numbered character (**X'40'**) is converted to a Big5 double-byte space character (**X'A140'**). A one byte space character (**X'40'**) is changed to an ASCII single-byte space character (**X'20'**). When specifying **TRAN_SGLSPACE** in the Edit Option file, all X'40' characters are changed to single-byte space characters (**X'20'**).

Double Byte Character Field Conversion (KANJI:OPK2)

Shift code is used for converting single-byte code double-byte code n. Single-byte code conversion is same as alphanumeric field conversion (OPK4). Double-byte conversion is same as double-byte character field conversion (OPK1). The following are exceptions.

- **Shift code:** The Big5 code set does not have a shift character. The shift code character is used for converting single-byte code and double-byte code. the shift code itself is not converted. When the shift code character is input, output data length becomes shorter than the original input data length, and **X'FF'** is added for shift code characters in the output data. When specifying field padding code in the Edit Option file, padding code can be replaced with specified single-byte code.
- **Assumption of shift code:** When the first byte of a field is not a shift code, data conversion is in single-byte format. When the first character of the field is double-byte, double-byte conversion will be assumed by specifying TRAN_START_DOUBLE in the Edit Option file.

Customizing the Code Conversion Table

When converting from IBM Traditional Chinese to Big5, the FX Code Converter uses standard code conversion table shown in Table 5-2. When using user-defined characters or using anything other than standard Big5 characters, you will need to customize the Code Conversion table.

Table 5-2 Big5 Code Conversion

File Name	Table Contents
HOSTBIG5	Include conversion information of EBCDIC and IBM Traditional Chinese to Big5

Open-to-Mainframe Character Code Conversion

This chapter describes open-system-to-mainframe (otm) character code conversion.

- [Overview](#)
- [Alphanumeric Field Conversion \(CHAR:OPK9\)](#)
- [Double Byte Character Field Conversion \(KANJI:OPK7\)](#)
- [Customizing the Code Conversion Table](#)

Overview

Single-byte code conversion involves changing code from ASCII to EBCDIC. Double-byte code conversion is from Big5 to IBM Traditional Chinese. The FX Code Converter provides the following types of character code conversion for each field data type, as shown in Table 6-1.

Table 6-1 otm Code Conversion

Input Field Data Type	Character Code Conversion	Field Type and Conversion Mode
ASCII	ASCII to EBCDIC	CHAR:OPK9
Big5	Big5 to IBM Traditional Chinese	KANJI:OPK6
ASCII and Big5	ASCII and Big5 mixture data to EBCDIC and IBM Traditional Chinese code conversion	KANJI:OPK7

All code conversion uses specified code conversion tables. Big5 code is converted to IBM Traditional Chinese.

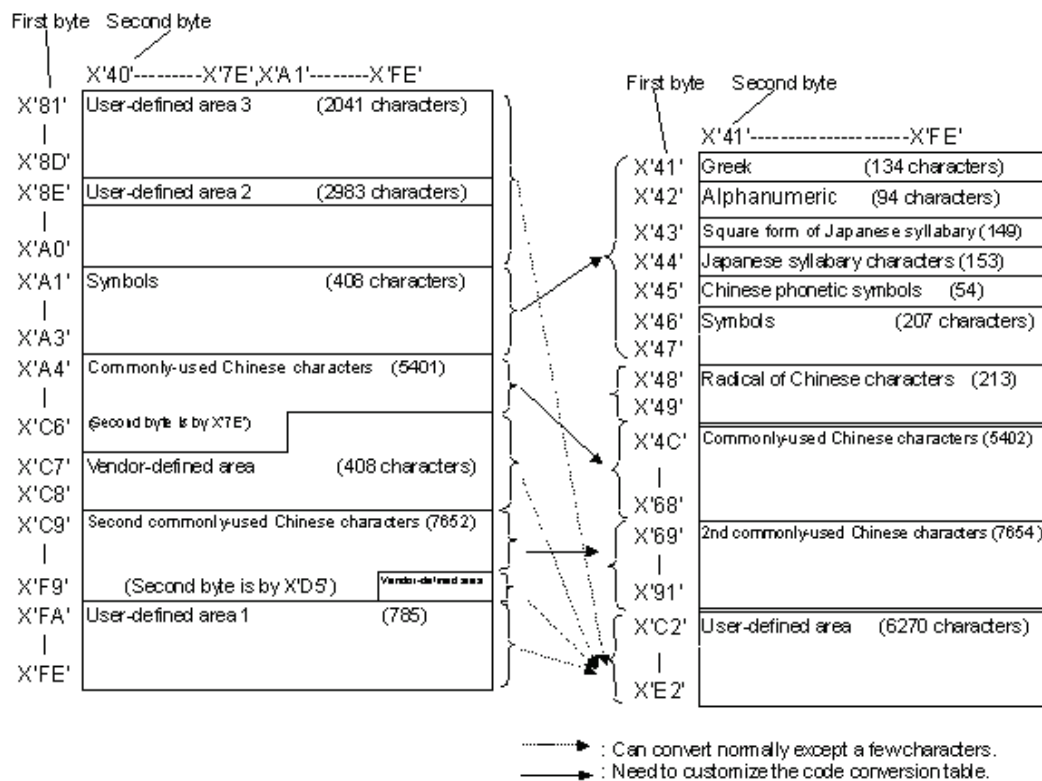

Figure 6-1 Converting from BIG5 Code to IBM Traditional Chinese Code

Alphanumeric Field Conversion (CHAR:OPK9)

All specified field data conversion assumes single-byte code. Code conversion follows the code conversion table shown in Table 6-2. Undefined characters are exceptions. An undefined character (a valid character is not defined in the conversion table) is a conversion is replaced by **X'FF'**. An undefined character can replace single-byte code by specifying single-byte in the Edit Option file.

Double Byte Character Field Conversion (KANJI:OPK6)

All data conversion assumes double-byte code. The following are exceptions.

- **Undefined character:** Undefined characters (valid characters not defined in the conversion table) are replaced by **X'FFFF'**. Undefined characters can replace double-byte code by specifying double-byte in the Edit Option file.
- **Unjustified character:** An unjustified character (first byte: **X'81'** through **X'FE'**, second byte: **X'40'** through **X'7E'**, **X'A1'** through **X'FE'**) is same as an undefined character. The space character (**X'20'**) is excluded.

Double Byte Character Field Conversion (KANJI:OPK7)

Single-byte conversion is the same as alphanumeric field conversion (OPK9). Double-byte conversion is same as double-byte character field conversion (OPK6). The following is an exception.

- Shift code: IBM Traditional Chinese code uses Shift code (**X'0E'**: double-byte code start, **X'0F'**: single-byte code start) to convert single-byte code and double-byte code. The converted code will be no longer than the previous unconverted code because shift code is padded. When converted code is longer than the allowable record length, an error is generated.
Note: when you specify **TRAN_NOSHIFT** in the Edit Option file, shift code is not padded. Customizing the Code Conversion Table

When converting code from Big5 to IBM Traditional Chinese, the FX Code Converter uses the standard code conversion table shown in Table 6-2. When using user-defined characters or using anything other than the standard Big5 characters, you will need to customize the code conversion table. For further information on customizing the Code Conversion table, refer to [Customizing the Code Conversion Table](#).

Table 6-2 Standard Code Conversion Table

File Name	Table Contents
BIG5HOST	Include conversion information of ASCII and Big5 to IBM Traditional Chinese.

Numeric Conversion

This chapter describes the considerations involved in performing numeric value conversions.

- [MTO Numeric Value Conversion Overview](#)
- [Packed Decimal Conversion \(NUM:OPA1\)](#)
- [Zoned Decimal Conversion \(NUM:OPA2\)](#)

MTO Numeric Value Conversion Overview

Numeric values are stored in mainframe systems as packed decimal or zoned decimal. The FX Code Converter provides the following types of numeric value conversion for each field data type, as shown in Table 7-1.

Table 7-1 Types of Numeric Value Conversion

Input Field Data Type	Numeric Value Conversion	Field Type and Conversion Mode
Packed decimal	Packed decimal data converted to character data	NUM:OPA1
Zoned decimal	Zoned decimal data converted to character data	NUM:OPA2

Numeric value conversion output is right-aligned. If an output field is not large enough for the converted value (the effective length of the converted field is longer than the output field length), an error is generated (error code: 757).

Conversely, if there is extra space in the output field (the effective length of the converted value is shorter than the output field length), the extra space preceding the effective field data is padded with 0 or a blank space(s).

Packed Decimal Conversion (NUM:OPA1)

Packed decimal conversion divides 1 byte of numeric (packed decimal) data in the specified field into top 4 bits and bottom 4 bits, then converts each group into 1 byte of character data, resulting in total of 2 bytes of character data. If the 1 byte of packed decimal data is out of range (top/bottom 4 bits: **X'A'** to **X'F'**), a wrong data error is generated (error code: 760). Packed decimal conversion is performed according to the options specified in the Edit Option file.

Sign

The bottom 4 bits in the last byte of packed decimal data contain the sign bits. Sign bits are recognized as follows:

- Sign bits indicating A, C, E, or F: plus
- Sign bits indicating B or D: minus
- Sign bits indicating a value other than above (0 through 9): wrong data (error code: 760)

The sign is inserted into the sign position specified in the Edit Option file.

Note: When the sign position is specified as “unsigned”, no minus sign is inserted for negative values (whose sign bits indicate B or D).

- Leading sign:

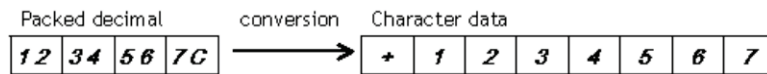

Figure 7-1 Conversion When “Leading sign” is Specified

- Trailing sign:

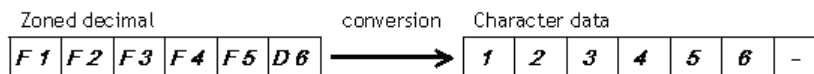

Figure 7-2 Conversion When “Trailing Sign” is Specified

- Insert sign before effective digits:

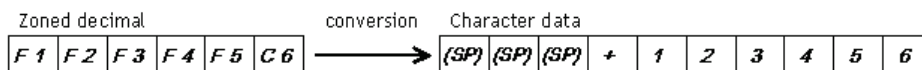

Figure 7-3 Conversion When “Insert Sign Before Effective Digits” Is Specified

- Unsigned:

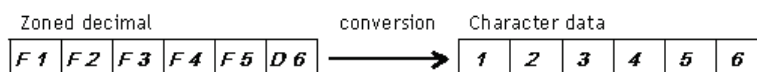

Figure 7-4 Conversion When “Unsigned” is Specified

Zero Suppression

Zero suppression replaces leading zeroes preceding the effective digits in the output field with spaces. Zero suppression is performed according to the option specified in the Edit Option file. Zeroes are suppressed in relation to sign position, as shown in the following examples.

- No zero suppression, Leading Sign:

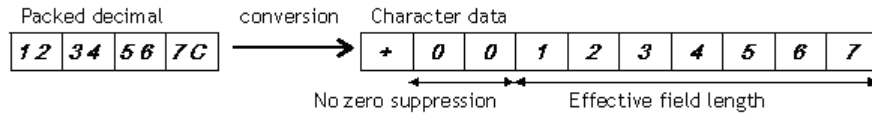

Figure 7-5 Conversion When "No zero suppression", "Leading sign" is Specified

- Zero suppression, Trailing sign:

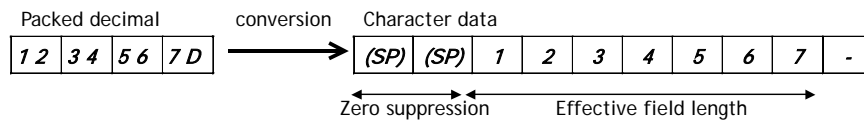

Figure 7-6 Conversion When "Zero suppression", "Trailing sign" is Specified

Decimal Point

A decimal point is inserted according to the number of decimal point specified in the Edit Option file. When 0 is specified, there will be no decimal point, and no decimal point is inserted.

- Decimal point: 3, Zero suppression, Insert sign before effective digits:

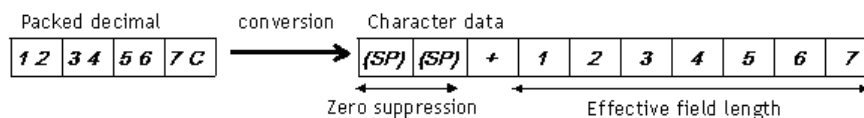

Figure 7-7 Conversion for Decimal Point = 3, "Zero suppression" and "Trailing sign" Specified

- Decimal point: 0, No zero suppression, Unsigned:

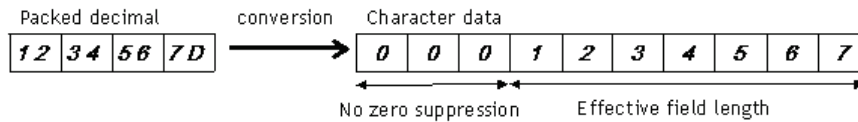

Figure 7-8 Conversion for Decimal Point = 0, “No zero suppression” and Unsigned” Specified

All-space Fields

All-space fields contain only spaces (all data is X'40') unconditionally generate a data error (error code: 760).

0-only fields: Fields that contain only 0 are converted according to the “All-space field” option in the Edit Option file. When the option to convert 0 in 0-only fields to 0 (TRAN_ALLSPACE_NORMAL) is specified, 0 is converted to 0 as in normal numeric value conversions. When the option to convert 0 in 0-only fields to spaces (TRAN_ALLSPACE_ZERO) is specified, all 0's are converted to spaces (X'20'), as shown in Figure 7-9. The sign position, zero suppression, and the number of decimal point specified in the Edit Option file, as well as the sign of the input data, are ignored.

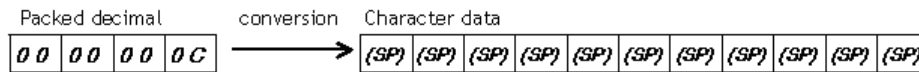

Figure 7-9 Conversion of 0 in a 0-only Field to Spaces

Zoned Decimal Conversion (NUM:OPA2)

Zoned decimal conversion takes 1 byte of numeric (zoned decimal) data in the specified field and converts the bottom 4 bits into 1 byte of character data. If the 1 byte of zoned decimal data is out of range (bottom 4 bits: **X'A to X'F**), a data error is generated (error code: 760). Zoned decimal conversion is performed according to the options specified in the Edit Option file.

Sign

The bottom 4 bits in the last byte of zoned decimal data contain the sign bits. Sign bits are recognized as follows:

- Sign bits indicating A, C, E, or F: plus
- Sign bits indicating B or D: minus
- Sign bits indicating a value other than above (0 through 9): wrong data (error code: 760)

The sign is inserted into the sign position specified in the Edit Option file.

Note: when the sign position is specified as "unsigned", no minus sign is inserted for negative values (whose sign bits indicate B or D).

- Leading Sign:

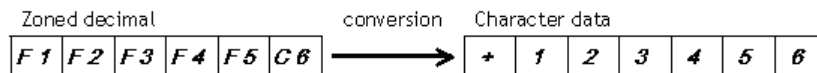

Figure 7-10 Conversion When "Leading sign" is Specified

- Trailing sign:

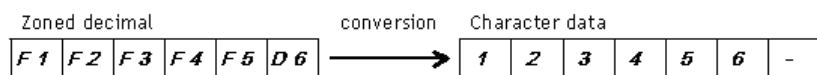

Figure 7-11 Conversion When "Trailing sign" is Specified

- Insert sign before effective digits:

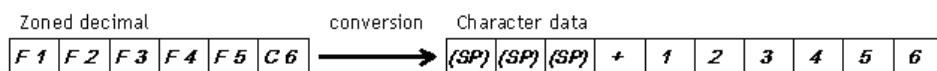

Figure 7-12 Conversion When "Insert sign before effective digits" is Specified

- Unsigned:

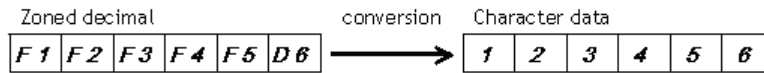

Figure 7-13 Conversion When “Unsigned” is Specified

Zero Suppression

Zero suppression replaces leading zeroes preceding the effective digits in the output field to spaces. Zero suppression is performed according to the option specified in the Edit Option file. Zeroes are suppressed in relation to sign position, as shown in the examples that follow.

- No zero suppression, Leading Sign:

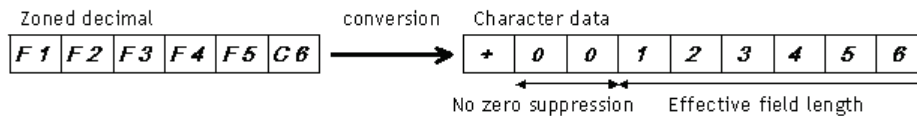

Figure 7-14 Conversion When “No zero suppression”, “Leading sign” is Specified

- Zero suppression, Trailing sign:

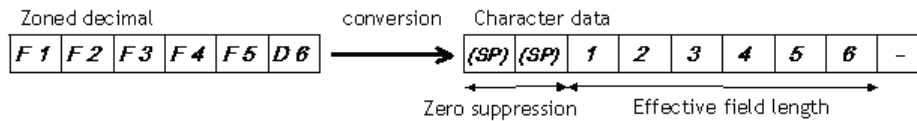

Figure 7-15 Conversion When “Zero suppression”, “Trailing sign” is Specified

Decimal Point

A decimal point is inserted according to the number of decimal point specified in the Edit Option file. When **0** is specified, there will be no decimal point, and no decimal point is inserted.

- Decimal point: 3, Zero suppression, Insert sign before effective digits:

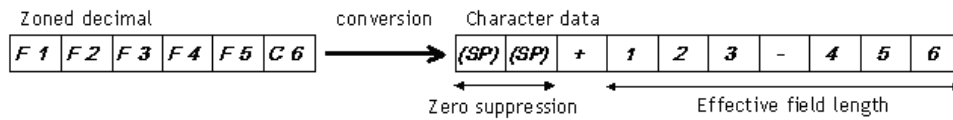

Figure 7-16 Conversion for Decimal Point = 3, "Zero suppression" and "Insert before effective digits" Specified

- Decimal point: 0, No zero suppression, Unsigned:

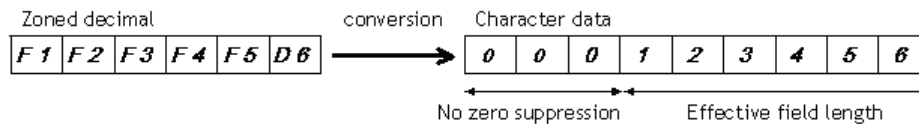

Figure 7-17 Conversion for Decimal Point = 0, "No zero suppression" and "Unsigned" Specified

All-space Fields

Fields that only contain spaces (all data is **X'40'**) unconditionally generates a data error (error code: 760).

0-only Fields

Fields that contain only **0** are converted according to the "All-space field" option in the Edit Option file.

When the option to convert 0 in 0-only fields to 0 (TRAN_ALLSPACE_NORMAL) is specified, 0 is converted to 0 as in normal numeric value conversions.

When the option to convert 0 in 0-only fields to spaces (TRAN_ALLSPACE_ZERO) is specified, all 0's are converted to spaces (**X'20'**), as shown in Figure 7-18. The sign position, zero suppression, and the number of decimal digits specified in the Edit Option file, as well as the sign of the input data, is ignored.

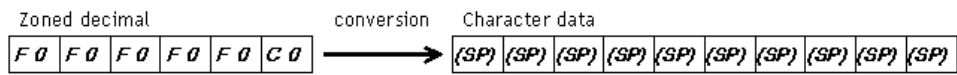

Figure 7-18 Conversion of 0 in a 0-only Field to Spaces



Customizing the Code Conversion Table

This chapter describes the procedures for customizing the code conversion table for use with your specific conversion requirements.

- [Operation Overview](#)
- [Utility Features](#)
- [Definition Statement Syntax](#)
- [Command Syntax for UNIX Systems](#)
- [Command Syntax for Windows Systems](#)
- [Examples of the ccnv Utility](#)

Operation Overview

Figure 8-1 illustrates the code conversion table customization process.

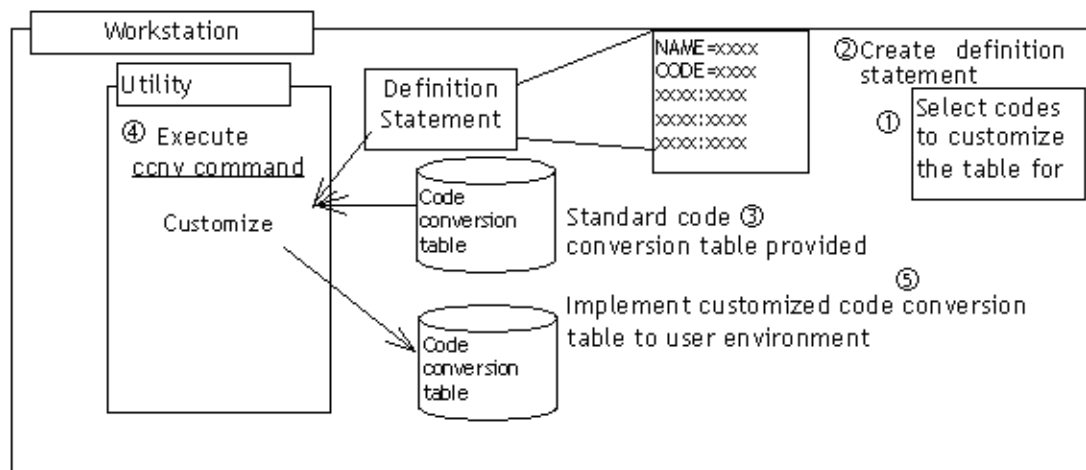

Operation Procedures

- ① Select the type of conversion and code to customize the table for, according to the user environment.
- ② Use an editor on the workstation (e.g. vi) to write definition statements specifying how the table is to be customized.
- ③ Place the code conversion table to customize in the directory where the customize utility is to be executed.
- ④ Execute customization by using the utility command (`ccnv`).
- ⑤ The customized code conversion table generated in the directory where the utility command was executed. Move this table to the user's environment (output directory can be changed by option).
- ⑥ Change the code conversion table directory and table name in Code Converter.

Figure 8-1 Overview of the ccnv Utility

Utility Features

The **ccnv** utility provides features necessary to customize code conversion tables. These are described below:

- **Table customization:** Customizes the specified code conversion table according to the user's customization information (definition statements) specified by the user. The standard code conversion table cannot be modified. This feature is also used for conversion of user-defined characters. See the example in section 10.5 for details.
- **Table information output:** Outputs information on the code conversion table such as the type of conversion, creation date, and date last modified.
- **Table dump output:** Outputs code conversion table dump results to a file. The contents of this dump output only concerns the codes, and do not include internal information such as header information contained in the code conversion table. The resulting file name is the code conversion table name with ".dmp" appended to the end as the file extension.
- **Standard table generation:** Re-generates the standard code conversion table provided. Use this feature when the standard code conversion table is modified or deleted unintentionally or by hard disk failures.

Definition Statement Syntax

This section describes the syntax of the definition statement used by the ccnv utility command to customize the code conversion table.

Definition Statement Syntax Rules

- Use single-byte alphanumeric characters to specify the definition statement (except comments).
- Types of definition statements (Table 8-1):

Table 8-1 Definition Statements

Definition Statement	Description
NAME statement	Specifies name of the code conversion table to customize.
TYPE statement	Specifies the type of conversion to customize.
CODE statement	Specifies the character code to customize.
Code customization statement	Specifies how the character code is converted.
Comments	Enter comments.

- Start position of the definition statement: Although there are no rules regarding the start position, it is recommended to keep the statement on one line, within 120 columns.
- Order of definition statements: The definition statements must be specified in the order shown in Figure 8-2.

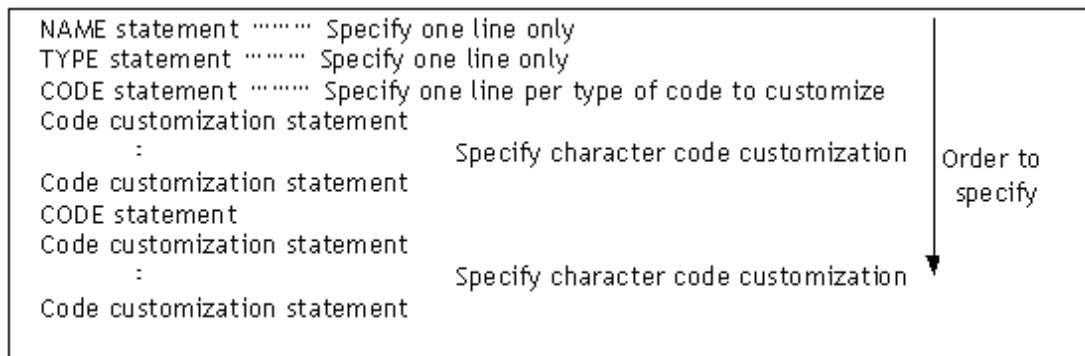

Figure 8-2 Order of Definition Statements

Definition Statement Details

- NAME statement
 - Syntax: `NAME=code_conversion_table_name_to_generate`
 - Parameters: Specify the code conversion table name to generate in alphanumeric characters. The maximum length is 255 characters, and the name must begin with an alphabet. When modifying an existing code conversion table and not creating a new one, specify '*'.
- TYPE statement
 - Syntax: `TYPE=type_of_conversion`
 - Parameters: Specify the type of code conversion to customize. Table 8-2 shows the options that can be specified.

Table 8-2 Syntax Options

Option	Description
HOSTtoBIG5	Customize the code conversion table to convert IBM Traditional Chinese to Big5
BIG5toHOST	Customize the code conversion table to convert Big5 to IBM Traditional Chinese

- CODE statement
 - Syntax: `CODE=type_of_code`
 - Parameters: Specify the type of code to customize. When none is specified, it is assumed from the type of conversion in the code conversion table passed by the -t option of the ccnv utility command. Table 8-3 shows the options that can be specified in the CODE statement.

Table 8-3 CODE Statement Options

Type of Conversion	Option	Description
HOSTtoBIG5	T_HOST	Customize table for IBM Traditional Chinese code
	EBCDIC	Customize table for EBCDIC code
BIG5toHOST	<u>BIG5</u>	Customize table for Big5 code
	ASCII	Customize table for ASCII code

- Code customization statement
 - Syntax: `Code_to_convert:Converted_code`
 When specifying more than one code, separate them with a comma (,). There are no rules regarding the columns to define the parameters, but each pair must be separated with a comma (,) or a line break.
 - Parameters: Specify `code_to_convert` from the code conversion table with hexadecimal. Specify the desired code after conversion in `converted_code`, also using hexadecimal. Table 8-4 shows the range of values that can be specified. Note that specifying any value outside this range generates an error.

Table 8-4 Range of Values

Code	Valid values	Remarks
EBCDIC	0x00—0xFF	Shift code raises an error
ASCII	0x00—0xFF	
T_HOST	First byte: 0x41—0x49, 0x4C—0x91, 0xC2—0xE2 Second byte: 0x41~0x7F, 0x81—0xFD0x4180	Value outside the valid range is an error
BIG5	First byte: 0x81—0xFE Second byte: 0x40—0x7E, 0xA1—0xFE	Value outside the valid is raises an error

- Comments: Enter comments.
 - Syntax: `#Comments`
 - Parameters: Anything entered between '#' and line break is treated as a comment.

Command Syntax for UNIX Systems

Use the **ccnv** command to customize code conversion tables. The syntax rules for the ccnv command are described below.

- **ccnv** command:

- Syntax: `ccnvΔ [option] Δ definition_statement_file_name`
(Δ indicates a single-byte space)
- Parameters: Specify the name of the definition statement file that defines the customization of the code conversion table. The file name must include the file extension “.txt”. When there is no file extension, an error message indicating that definition statements cannot be found is displayed.
- Command options:
 - D|-dΔdir: Specify the output directory for the code conversion table in dir. **Note:** This option can be used with other options for file output.
 - L|-l: Definition statements specified are additionally output to the result list. When this option is specified, lines with errors are output directly above the error message, and making corrections becomes easier.
 - P|-p: The generated code conversion table is dumped as a character based file. The table is output to the current directory where the command is executed, with a file name that includes the Code Conversion name and the file extension changed to “.dmp”. Use this file to review the customized table.
 - T|-t: Specifies the code conversion table name to customize. This option can be omitted when executing customization. It defaults to the standard table for the type of conversion specified in the definition statement.
 - I|-I: Outputs code conversion table information such as the creation date and date last modified to standard output.

Command Syntax for Windows Systems

Use the **ccnv.exe** utility to customize code conversion tables. This section describes the use of this utility (Figure 8-3).

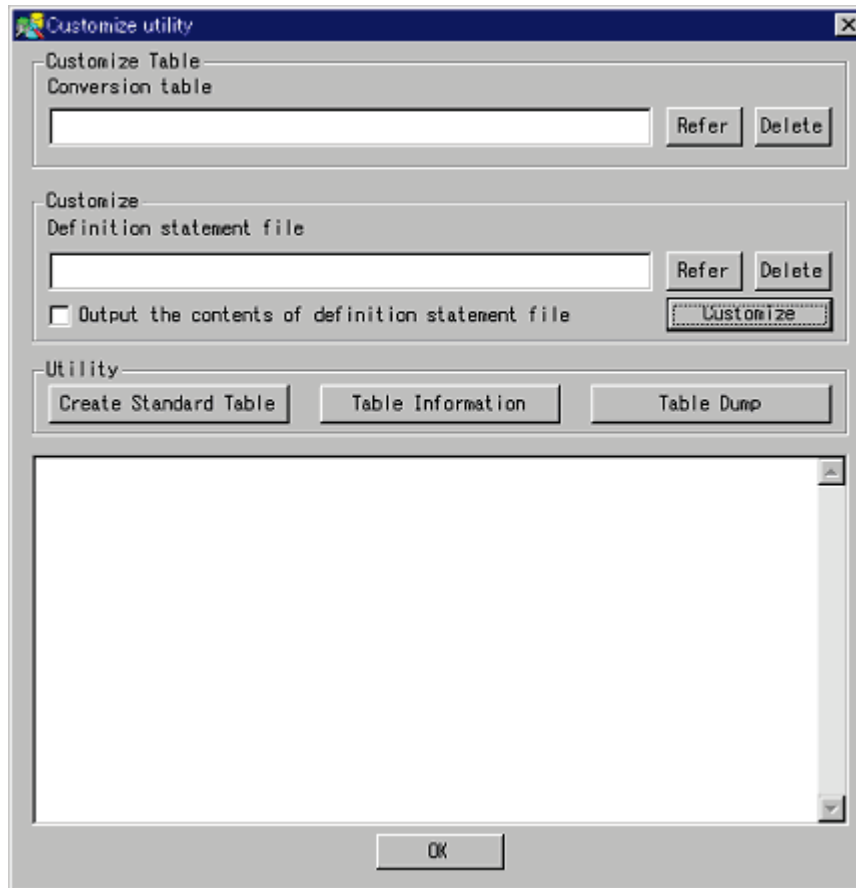

Figure 8-3 Using the ccnv Utility with Windows Systems

1. Execute customizing: Select the [Customize] button after selecting the conversion table file and the definition statement file.
2. Output table information: Select the [Table Information] button; the generated date and history will be displayed.
3. Output table dump: Select the [Table Dump] button, and then execute WordPad; a dump of the conversion table will be displayed.
4. Create Standard Table: Select the [Create Standard Table] button, then select "Create standard conversion table".

Examples of the ccnv Utility

Customizing Character Conversion

In the following example, EBCDIC code `x'00'` is converted to ASCII code `x'31'`; IBM Traditional Chinese code `x'5965'` and `x'5B99'` are converted to Big5 code `x'F8A6'` and `x'A4AA'` respectively.

```
NAME=TEST1.tbl           # Output table name
TYPE= HOSTtoBIG5        # Type of conversion
CODE=EBCDIC             # Code to customize
00:31                   # X'00 -> X'31
CODE= T_HOST           # Code to customize
5965:F8A6,             # X'5965 -> X' F8A6
5B99:A4AA             # X'5B99 -> X' A4AA
```

Figure 8-4 Definition Statement for EBCDIC to ASCII and Traditional Chinese to Big5 Code Conversion

```
$ ccnv test1.txt
* TABLE INFORMATION *  NEW TABLE NAME      : TEST1.tbl
                       CHANGE TABLE NAME: HOSTBIG5.tbl

TRANS TYPE   LENGTH  CODE AREA          CREATE DATE      CHANGE DATE
EBCDIC->ASCII 000256  0x00-0xFF         2002/06/04,14:51 0000/00/00,00:00 0
HOST->BIG5    043040  1byte:0x41-49    2002/06/04,14:51 0000/00/00,00:00 0
                0x4C-91
                0xC2-E2
                2byte:0x41-7F
                0x81-FD
                0x4180

CCNV-102I Code conversion table successfully generated.
CCNV-101I Utility terminated. Termination code = 0.
$
```

Figure 8-5 EBCDIC to ASCII and Traditional Chinese to Big5 Code Conversion: Execution Result

Converting Private Characters

User-defined characters are converted in IBM Traditional Chinese to Big5 code conversion. User-defined characters X'47B0', X'47B1', X'47B2' created on the mainframe computer are respectively converted to user-defined characters X'FA40', X'FA41', X'FA42' created on the workstation.

```
NAME=TEST2.tbl           # Output table name
TYPE= HOSTtoBIG5        # Type of conversion
CODE= T_HOST            # Code to customize
47B0:FA40,              # X'47B0 -> X'FA40
47B1:FA41,              # X'47B1 -> X'FA41
47B2:FA42               # X'47B2 -> X'FA42
```

Figure 8-6 Definition Statement for IBM Traditional Chinese to Big5 Code Conversion

```
$ ccnv test2.txt
* TABLE INFORMATION *  NEW TABLE NAME      : TEST2.tbl
                       CHANGE TABLE NAME: HOSTBIG5.tbl

TRANS TYPE   LENGTH   CODE AREA      CREATE DATE      CHANGE DATE
EBCDIC->ASCII 000256  0x00-0xFF      2002/06/04,14:52 0000/00/00,00:00 0
HOST->BIG5    043040  1byte:0x41-49  2002/06/04,14:52 0000/00/00,00:00 0
                0x4C-91
                0xC2-E2
                2byte:0x41-7F
                0x81-FD
                0x4180

CCNV-102I Code conversion table successfully generated.
CCNV-101I Utility terminated. Termination code = 0.
$
```

Figure 8-7 IBM Traditional Chinese to Big5 Code Conversion: Execution Result

Outputting Code Conversion Table Information

Code conversion table information is output to standard output. Enter the following command at the command line:

```
ccnv r -p r -t r HOSTBIG5.tbl
```

```
* TABLE INFORMATION * TABLE NAME: HOSTBIG5.tbl
```

TRANS TYPE	LENGTH	CODE AREA	CREATE DATE	CHANGE DATE
EBCDIC->ASCII	000256	0x00-0xFF	2002/06/04,11:48	0000/00/00,00:00 0
HOST->BIG5	043040	1byte: 0x41-49 0x4C-91 0xC2-E2 2byte: 0x41-7F 0x81-FD 0x4 180	2002/06/04,11:48	0000/00/00,00:00 0

```
CCNV-10WI Code conversion table information output succeeded.  
CCNV-10II Utility terminated. Termination code = 0.
```

Figure 8-8 Code Conversion Execution Result

Outputting to a File

Code conversion table dump information is output to a file. Enter the following command at the command line:

```
ccnv r -p r -t r HOSTBIG5.tbl
```

*** EBCDIC CODE TRANS TABLE ***										[ASCII]							
[EBCDIC]	+0	+1	+2	+3	+4	+5	+6	+7	+8	+9	+a	+b	+c	+d	+e	+f	0123456789abcdef
0x00	00	01	02	03	ff	09	ff	7f	ff	ff	ff	0b	0c	0d	0e	0f
0x10	10	11	12	13	ff	0a	08	ff	18	19	ff	ff	1c	1d	1e	1f
0x20	ff	ff	ff	ff	0a	17	1b	ff	ff	ff	ff	ff	05	06	07	
*** HOST CODE TRANS TABLE ***										[BIG5]							
[HOST]	+0	+1	+2	+3	+4	+5	+6	+7									0 1 2 3 4 5 6 7
0x4140	----	a35c	a35d	a35e	a35f	a360	a361	a362									α β γ δ ε ζ η
0x4148	a363	a364	a365	a366	a367	a368	a369	a36a									θ ι κ λ μ ν ξ ο
0x4150	a36b	a36c	a36d	a36e	a36f	a370	a371	a372									π ρ σ τ υ φ χ ψ
0x4158	a373	ffff	ffff	ffff	ffff	ffff	ffff	ffff									ω
0x4160	ffff	a344	a345	a346	a347	a348	a349	a34a									A B Γ Δ E Z H
0x4168	a34b	a34c	a34d	a34e	a34f	a350	a351	a352									Θ Ι Κ Λ Μ Ν Ξ Ο
0x4170	a353	a354	a355	a356	a357	a358	a359	a35a									Π Ρ Σ Τ Υ Φ Χ Ψ
0x4178	a35b	ffff	ffff	ffff	ffff	ffff	ffff	ffff									Ω
0x4180	ffff	ffff	ffff	ffff	ffff	ffff	ffff	ffff									
.																	
0x4c40	----	a440	a441	a442	a443	a444	a445	a446									一 乙 丁 七 乃 九 了
0x4c48	a447	a448	a449	a44a	a44b	a44c	a44d	a44e									二 人 儿 入 八 几 刀 ?
0x4c50	a44f	a450	a451	a452	a453	a454	a455	a456									力 七 十 卜 又 三 下 文
.																	

Figure 8-9 Execution Result

Troubleshooting

This chapter provides troubleshooting information for Code Converter, lists and describes the error codes, and provides instructions for contacting the Hitachi Data Systems Support Center.

- [Troubleshooting](#)
- [Error Codes](#)
- [Calling the Support Center](#)

Troubleshooting

For general troubleshooting information on the Hitachi RAID storage systems, please refer to the *User and Reference Guide* for the storage system.

If you have a problem with Code Converter operations, first make sure that the problem is not being caused by other software or hardware, and try rebooting the host server.

When errors are detected, error codes and messages are displayed and/or logged. Table 9-1 and Table 9-2 list the error codes for Code Converter and provide recommended action for resolving the error conditions.

Error Codes

ccnv Messages

For the error message CCNVn₁n₂n₃-s₁, the following applies:

- **n₁**: Indicates the program that output the message.
 - 1**: Message output by the utility.
- **n₂n₃**: Message sequence number.
- **s₁**: An alphabet to indicate who the message is for.
 - I**: Message for user.

Message text describes the error condition. **System action** describes actions taken by the system after the message is output, and **User Action** describes actions to be taken by the user once the message is received. Table 9-1 lists and describes the ccnv error messages and provides the system action and user action for the error conditions.

Table 9-1 Customizing the Code Conversion Table (ccnv): Error Messages

Error Code	Error Message and Description	System Action, User Action
CCNV101-I	Utility terminated. Termination code = termination_code. CCNV has terminated. The termination code is shown in decimal number. The termination codes indicate the following: 00: Successfully terminated. 08: Error found in definition statement. The statement was ignored to continue operation. 12: Definition statement could not be executed due to error. Operation aborted. Messages with a termination code other than 00 will be preceded by an error message indicating the error detail.	System action: Terminates operation.
CCNV102-I	Code conversion table successfully generated. A code conversion table was created with the specified name.	System action: Operation continues (Termination code 00).
CCNV103-I	Cannot generate code conversion table due to error. Failed to create code conversion table due to reasons indicated by the preceding error message.	System action: Proceeds to the next definition statement (Termination code 12). User action: Re-execute after reviewing the contents of the preceding message and making the necessary corrections.
CCNV104-I	Definition statement not specified. Cannot execute utility because there is no definition statement specified.	System action: Terminates operation (Termination code 12). User action: Specify the definition statements and re-execute.

Error Code	Error Message and Description	System Action, User Action
CCNV105-I	NAME statement is wrong value or not specified.	<p>System action: Terminates operation (Termination code 12).</p> <p>User action: Re-execute after checking the following:</p> <ul style="list-style-type: none"> § The table name is specified in 255 or less alphanumeric characters beginning with an alphabet. § NAME is specified.
CCNV106-I	TYPE statement is wrong value or not specified.	<p>System action: Terminates operation (Termination code 12).</p> <p>User action: Re-execute after checking the following:</p> <ul style="list-style-type: none"> § HOSTtoBIG5 or BIG5toHOST is specified for TYPE § TYPE is specified.
CCNV108-I	Code (code) to customize does not exist in the code conversion table.	<p>System action: Proceeds to the next definition statement (Termination code 08).</p> <p>User action: Check the code to customize, and then re-execute.</p>
CCNV109-I	The I/O error of the code conversion table occurred. An error occurred during input/output of the code conversion table.	<p>System action: Terminates operation (Termination code 12).</p> <p>User action: Re-execute after checking the following:</p> <ul style="list-style-type: none"> § The code conversion table to customize has a readable file attribute. § The code conversion table to customize exists. § A read-only table that has the same name as the output table exists in the same directory with an attribute. § The output directory of the table is read-only.
CCNV10A-I	Insufficient memory to generate the code conversion table.	<p>System action: Terminates operation (Termination code 12).</p> <p>User action: Re-execute after increasing available memory.</p>
CCNV10B-I	The parameter of CODE statement is mismatching with the parameter of a TYPE statement. Parameter option for CODE cannot be specified with the type of conversion specified.	<p>System action: Proceeds to the next definition statement (Termination code 12).</p> <p>User action: Re-execute after checking the options for TYPE and CODE.</p>
CCNV10C-I	Cannot find Definition statement file. The definition statement file specified in the command parameter does not exist in the directory where the utility is executed.	<p>System action: Terminates operation (Termination code 12).</p> <p>User action: Check that the definition statement file specified exists, and if it does not, re-execute after setting up the file.</p>
CCNV10D-I	The I/O error of Definition statement file occurred. An error occurred during input/output of the Definition Statement file.	<p>System action: Terminates operation (Termination code 12).</p> <p>User action: Check the condition of the Definition Statement file or the system, then re-execute.</p>

Error Code	Error Message and Description	System Action, User Action
CCNV10E-I	Cannot find the code conversion table to customize. The code conversion table specified with "-T" or "-t" parameter of the utility does not exist in the directory where the utility is executed.	System action: Terminates operation (Termination code 12). User action: Check that the code conversion table specified exists, then re-execute.
CCNV10F-I	CODE statement is wrong value. Operation is executed with CODE=code. Wrong value is specified for CODE statement.	System action: Proceeds to the next definition statement (Termination code 08). User action: Check that the value for CODE matches the type of conversion, then re-execute.
CCNV10G-I	Size of code (code) to customize is wrong. Wrong code specified for the code to be customized.	System action: Proceeds to the next definition statement (Termination code 08). User action: Re-execute after checking the following for the code to be customized: § A shift code is not specified for the code to be customized.
CCNV10H-I	Failed to generate code conversion table. Failed to generate code conversion table due to an unspecified error.	System action: Operation continues (Termination code 12).
CCNV10I-I	Cannot specify more than one NAME statement. More than one NAME statement is specified.	System action: Operation continues with the first NAME statement as the valid NAME statement (Termination code 08). User action: Check the NAME statement and re-execute with only the desired NAME statement specified.
CCNV102-I	Code conversion table successfully generated. A code conversion table was created with the specified name.	System action: Operation continues (Termination code 00).
CCNV103-I	Cannot generate code conversion table due to error. Failed to create code conversion table due to reasons indicated by the preceding error message.	System action: Proceeds to the next definition statement (Termination code 12). User action: Re-execute after reviewing the contents of the preceding message and making the necessary corrections.
CCNV104-I	Definition statement not specified. Cannot execute utility because there is no definition statement specified.	System action: Terminates operation (Termination code 12). User action: Specify the definition statements and re-execute.
CCNV105-I	NAME statement is wrong value or not specified.	System action: Terminates operation (Termination code 12). User action: Re-execute after checking the following: § The table name is specified in 255 or less alphanumeric characters beginning with an alphabet. § NAME is specified.

Error Code	Error Message and Description	System Action, User Action
CCNV106-I	TYPE statement is wrong value or not specified.	<p>System action: Terminates operation (Termination code 12).</p> <p>User action: Re-execute after checking the following:</p> <ul style="list-style-type: none"> § HOSTtoBIG5 or BIG5toHOST is specified for TYPE § TYPE is specified.
CCNV108-I	Code (code) to customize does not exist in the code conversion table.	<p>System action: Proceeds to the next definition statement (Termination code 08).</p> <p>User action: Check the code to customize, and then re-execute.</p>
CCNV109-I	<p>The I/O error of the code conversion table occurred.</p> <p>An error occurred during input/output of the code conversion table.</p>	<p>System action: Terminates operation (Termination code 12).</p> <p>User action: Re-execute after checking the following:</p> <ul style="list-style-type: none"> § The code conversion table to customize has a readable file attribute. § The code conversion table to customize exists. § A read-only table that has the same name as the output table exists in the same directory with an attribute. § The output directory of the table is read-only.
CCNV10A-I	Insufficient memory to generate the code conversion table.	<p>System action: Terminates operation (Termination code 12).</p> <p>User action: Re-execute after increasing available memory.</p>
CCNV10B-I	<p>The parameter of CODE statement is mismatching with the parameter of a TYPE statement.</p> <p>Parameter option for CODE cannot be specified with the type of conversion specified.</p>	<p>System action: Proceeds to the next definition statement (Termination code 12).</p> <p>User action: Re-execute after checking the options for TYPE and CODE.</p>
CCNV10C-I	<p>Cannot find Definition statement file.</p> <p>The definition statement file specified in the command parameter does not exist in the directory where the utility is executed.</p>	<p>System action: Terminates operation (Termination code 12).</p> <p>User action: Check that the definition statement file specified exists, and if it does not, re-execute after setting up the file.</p>
CCNV10D-I	<p>The I/O error of Definition statement file occurred.</p> <p>An error occurred during input/output of the Definition Statement file.</p>	<p>System action: Terminates operation (Termination code 12).</p> <p>User action: Check the condition of the Definition Statement file or the system, then re-execute.</p>
CCNV10E-I	<p>Cannot find the code conversion table to customize.</p> <p>The code conversion table specified with "-T" or "-t" parameter of the utility does not exist in the directory where the utility is executed.</p>	<p>System action: Terminates operation (Termination code 12).</p> <p>User action: Check that the code conversion table specified exists, then re-execute.</p>
CCNV10F-I	<p>CODE statement is wrong value. Operation is executed with CODE=code.</p> <p>Wrong value is specified for CODE statement.</p>	<p>System action: Proceeds to the next definition statement (Termination code 08).</p> <p>User action: Check that the value for CODE matches the type of conversion, then re-execute.</p>

Error Code	Error Message and Description	System Action, User Action
CCNV10G-I	Size of code (code) to customize is wrong. Wrong code specified for the code to be customized.	System action: Proceeds to the next definition statement (Termination code 08). User action: Re-execute after checking the following for the code to be customized: § A shift code is not specified for the code to be customized.
CCNV10H-I	Failed to generate code conversion table. Failed to generate code conversion table due to an unspecified error.	System action: Operation continues (Termination code 12).
CCNV10I-I	Cannot specify more than one NAME statement. More than one NAME statement is specified.	System action: Operation continues with the first NAME statement as the valid NAME statement (Termination code 08). User action: Check the NAME statement and re-execute with only the desired NAME statement specified.
CCNV10J-I	Cannot specify more than one TYPE statement. More than one TYPE statement is specified.	System action: Operation continues with the first TYPE statement as the valid TYPE statement (Termination code 08). User action: Check the TYPE statement and re-execute with only the desired TYPE statement specified.
CCNV10K-I	Failed to open file when generating the code conversion table. Encountered an error when opening a file while generating the code conversion table.	System action: Terminates operation (Termination code 12). User action: Check the output directory for the code conversion table, then re-execute.
CCNV10K-I	Failed to open file when generating the code conversion table. Encountered an error when opening a file while generating the code conversion table.	System action: Terminates operation (Termination code 12). User action: Check the output directory for the code conversion table, then re-execute.
CCNV10M-I	Failed to open the standard code conversion table. Encountered an error when opening a file while generating the standard code conversion table.	System action: terminates operation (Termination code 12). User action: Check the output directory for the code conversion table, then re-execute.
CCNV10N-I	The code to customize (code) does not match with the parameter of CODE statement. The code to customize specified does not match the code specified by CODE (e.g., double-byte code was specified as the code to customize while EBCDIC was specified for CODE).	System action: Proceeds to the next definition statement (Termination code 08). User action: Check CODE statement and the code to customize, and then re-execute.
CCNV10O-I	Line is longer than the maximum length. This line will be ignored. There is a line of definition statement over 120 columns.	System action: Proceeds to the next definition statement (Termination code 08). User action: Modify the definition statement to fit within 120 columns, and then re-execute.
CCNV10P-I	Unrecognizable definition exists in line line_no. The unrecognizable definition will be ignored. Unrecognizable character string is found in the definition statement indicated in the line of error message.	System action: Proceeds to the next definition statement (Termination code 08). User action: Review the definition statement in the line with error, then re-execute.

Error Code	Error Message and Description	System Action, User Action
CCNV10Q-I	Failed to output characters for code conversion table. File open failed when outputting characters for the code conversion table.	System action: Terminates operation (Termination code 12). User action: Check the output directory, then re-execute.
CCNV10S-I	Character output for code conversion table succeeded. Character output for the code conversion table completed successfully.	
CCNV10T-I	Cannot output characters for code conversion table due to error encountered. A critical error was encountered during operation.	System action: Terminates operation (Termination code 12). User action: Check the preceding error message to determine the cause of error, then re-execute
CCNV10U-I	Standard code conversion table generated successfully. The standard code conversion table output completed successfully.	System action: Terminates operation (Termination code 0).
CCNV10V-I	Cannot output standard code conversion table due to error encountered. A critical error was encountered during operation.	System action: Terminates operation (Termination code 12). User action: Check the preceding error message to determine the cause of error, and then re-execute.
CCNV10W-I	Code conversion table information output succeeded.	System action: Terminates operation (Termination code 0).
CCNV10Y-I	Cannot make changes to the standard code conversion table. The standard code conversion table provided cannot be changed.	System action: Terminates operation (Termination code 12). User action: Create a new table when customizing the standard code conversion table.
CCNV10Z-I	Version of the code conversion table is wrong.	System action: Terminates operation (Termination code 12). User action: Check the code conversion table, then re-execute.
CCNV110-I	Code conversion table is wrong. Code conversion table is corrupted, or a file other than a code conversion table is specified.	System action: Terminates operation (Termination code 12). User action: Use a valid code conversion table. If the table is corrupted for any reason, re-execute after regenerating the standard code conversion table.
CCNV111-I	Code conversion table to customize is not specified. Tried to output code conversion table information or code conversion table dump with options -I(-i) or -P(-p), but the code conversion table is not specified.	System action: Terminates operation (Termination code 12). User action: Specify the code conversion table with the -T(-t) option after options -I(-i) or -P(-p).
CCNV113-I	Encountered an unexpected error. Could not obtain necessary information during utility execution due to reasons such as memory corruption.	System action: Terminates operation (Termination code 12). User action: Check the system environment, then re-execute.

Error Code	Error Message and Description	System Action, User Action
CCNV114-I	<p>The range of codes before and after the conversion does not match.</p> <p>Tried to customize a table that converts into EUC code, but the converted code does not correspond to the EUC code range.</p>	<p>System action: Terminates operation (Termination code 12).</p> <p>User action: Correct code range to match EUC code set 1 or 3, and then re-execute.</p>
CCNV115-I	<p>Converted code (code) does not exist in the code conversion table.</p> <p>Converted code does not exist in the code conversion table. This statement is ignored.</p>	<p>System action: Proceeds to the next definition statement (Termination code 08).</p> <p>User action: Check the converted code, then re-execute.</p>
CCNV116-I	<p>The value specified for the converted code (code) is not right.</p>	<p>A coding scheme where the converted code is a double-byte code was specified a value larger than 2 bytes.</p>

FX Code Converter Error Codes and Basic Troubleshooting Guidelines

Table 9-2 lists and describes the FX Code Converter error codes and provides recommended action for resolving the error condition. When an error occurs and the cause cannot be identified, please gather the following information and contact your Hitachi Data Systems representative.

UNIX Systems:

- Error code number
- Parameter definition file
- Field definition file
- Edit Option File
- libuoc.ver (found in /usr/lib)
- Data collected both before and after data exchange
- Any appropriate FX troubleshooting information

Windows Systems:

- Error Code number
- Parameter definition file
- Field definition file
- Edit Option File
- libuoc.ver found in c:\WINDOWS
- Data collected both before and after data exchange
- Any appropriate FX troubleshooting information

Table 9-2 FX Code Converter Error Codes

Error Code	Error Message	Description	Action
-603	"Parameter : CODE_CONV select error(USER-EDIT)"	Specification of CODE_CONV which cannot be used by UOC function is wrong.	Do not specify CODE_CONV.
-604	"Parameter : DELIMITER select error(USER-EDIT)"	Specification of DELIMITER which cannot be used by UOC function is wrong.	Do not specify DELIMITER.
-605	"Parameter : EMPTY select error(USER-EDIT)"	Specification of EMPTY which cannot be used by UOC function is wrong.	Do not specify EMPTY.
-606	"Parameter : RDW select error(USER-EDIT)"	Specification of RDW which cannot be used by UOC function is wrong.	Do not specify RDW.

Error Code	Error Message	Description	Action
-607	"Parameter : DELIMITER(No) select error(USER-EDIT)"	The delimiter is not specified for the UOC function (otm).	Please specify delimiter in the Field Definition file.
-615	"Uoc information buffer : Allocation error"	Cannot allocate memory for UOC Control Information Table.	Select Error from the Help menu to view the system error code, and then check the operating system document for error details.
-616	"Edit log buffer : Allocation error"	Cannot allocate memory for UOC edit interface logging.	Select Error from the Help menu to view the system error code, and then check the operating system document for error details.
-617	"Output log buffer : Allocation error"	Cannot allocate memory for UOC output interface/pipe output interface logging.	Select Error from the Help menu to view the system error code, and then check the operating system document for error details.
-640	"Null pointer (fcuucRCedit) error"	Null pointer passed from FCU.	Please confirm the FCU configuration is correct.
-641	"Field definition file open error"	Cannot open the Field Definition file.	Select Error from the Help menu to view the system error code, and then check the operating system document for error details.
-642	"Edit option file open error"	Cannot open the Edit Option file.	Select Error from the Help menu to view the system error code, and then check the operating system document for error details.
-643	"Field definition file read error"	Cannot read the Field Definition file.	Select Error from the Help menu to view the system error code, and then check the operating system document for error details.
-644	"Edit option file read error"	Cannot read the Edit Option file.	Select Error from the Help menu to view the system error code, and then check the operating system document for error details.
-645	"Field definition file : Top point/field length over flow error"	The Field Definition file parameter specifies first byte position or field length that goes beyond the edit source buffer length.	Please check the Field Definition file.
-646	"Field definition file : Output field size over flow"	Output field length is larger than the maximum record length (32KB).	Please check the Field Definition file.
-647	"Edited size error"	The total size of the edited record is 0 byte.	Please check the Field Definition file.
-648	"Memory allocate error"	Cannot allocate memory for tracing.	Select Error from the Help menu to view the system error code, and then check the operating system document for error details.
-649	"Record format error"	The length of the dataset is not fixed.	Please check the dataset settings and installation of FAL/FCU.
-650	"Field definition file : Top point error"	Byte position of the Field Definition file parameter is wrong.	Please check the Field Definition file.

Error Code	Error Message	Description	Action
-651	"Field definition file : Field size error"	Field length of the Field Definition file parameter is wrong.	Please check the Field Definition file.
-652	"Field definition file : Item count error"	The number of the Field Definition file parameter is less than required.	Please check the Field Definition file.
-653	"Field definition file : Edit kind error"	Field attribute of Field Definition file parameter is wrong.	Please check the Field Definition file.
-655	"Memory allocate error"	Cannot allocate memory for reading field information.	Select Error from the Help menu to view the system error code, and then check the operating system document for error details.
-656	"Field definition file : Character is not #/fld/end error".	A value other than fld, end, or # is specified in the Field Definition file.	Please check the Field Definition file
-657	"Memory allocate error"	Cannot allocate memory for reading the Field Definition file.	Select Error from the Help menu to view the system error code, and then check the operating system document for error details.
-659	"Memory allocate error"	Cannot allocate memory for reading the Edit Option file.	Select Error from the Help menu to view the system error code, and then check the operating system document for error details.
-660	"Edit option file : Invalid format error"	Conversion mode or end indicator of the Edit Option file is wrong.	Please check the Edit Option file. (conversion mode need to close by "]")
-661	"Edit option file : Information over flow"	The Edit Option file contains too much information or does not contain a "[]".	Please check the Edit Option file.
-662	"Edit option file : Invalid format error"	Conversion mode of the Edit Option file is wrong.	Please check the Edit Option file.
-663	"Edit option file : Information count error"	Number of the Edit Option file parameter is insufficient.	Please check the Edit Option file.
-664	"Field definition file : Non end mark or non fld area error"	Field definition file does not have an "end" statement or statements that start with "fld".	Please check the Field Definition file.
-665	"Edit option file : Edit table option error"	Conversion mode specified in the Field Definition file is not defined in the Edit Option file.	Please check the Edit Option file and Field Definition file.
-666	"Edit option file : Edit kind or end mark error"	Edit block or "end" statement is missing.	Please check the Edit Option file.
-667	"Memory allocate error"	Cannot allocate memory for retrieving field information.	Select Error from the Help menu to view the system error code, and then check the operating system document for error details.
-668	"Memory allocate error"	Cannot allocate memory for retrieving the Field Definition file name.	Select Error from the Help menu to view the system error code, and then check the operating system document for error details.
-669	"Memory allocate error"	Cannot allocate memory for retrieving field information.	Select Error from the Help menu to view the system error code, and then check the operating system document for error details.

Error Code	Error Message	Description	Action
-670	"Memory allocate error"	Cannot allocate memory for retrieving the Edit Option file name.	Select Error from the Help menu to view the system error code, and then check the operating system document for error details.
-671	"Edit option file : Wrong type of code conversion in the 2 byte code conversion"	Double-byte code conversion in the Edit Option file contains a wrong type of code conversion.	Please check the Edit Option file.
-672	"Edit option file : Wrong replacement code for undefined 1 byte character in the 2 byte code conversion"	Double-byte code conversion in the Edit Option file contains a wrong replacement code for undefined single-byte characters.	Please check the Edit Option file.
-673	"Edit option file : Wrong replacement code for undefined 2 byte character in the 2 byte code conversion"	Double-byte code conversion in the Edit Option file contains a wrong replacement code for undefined double-byte characters.	Please check the Edit Option file.
-674	"Edit option file : Wrong code conversion option in the 2 byte code conversion"	Double-byte code conversion in the Edit Option file contains a wrong code conversion option.	Please check the Edit Option file.
-675	"Edit option file : Data string type kind error in the 2 byte code conversion"	Double-byte code conversion in the Edit Option file contains a wrong single-byte/double-byte.	Please check the Edit Option file.
-676	"Code conversion : Parameter error"	Wrong parameter in double-byte or single-byte code conversion.	Please confirm the FCU configuration is correct.
-677	"Code conversion : NOT COpen error"	Double-byte or single-byte code conversion error in "Copen" (pre-processing) operation.	Please check the Edit Option file directory.
-678	"Code conversion : Can not find exchange table error"	Conversion table does not exist for double-byte or single-byte code conversion.	Please check the code conversion table.
-679	"Code conversion : Interface area error"	Conversion routine interface error occurred in double-byte or single-byte code conversion.	Please confirm the FCU configuration is correct.
-680	"Code conversion : Invalid exchange table error"	Conversion table is wrong in double-byte or single-byte code conversion.	Please check the code conversion table.
-681	"Code conversion : Can not Area get for exchange table error"	Cannot allocate space to read conversion table for double-byte or single-byte code conversion.	Select Error from the Help menu to view the system error code, and then check the operating system document for error details.
-682	"Code conversion : Exchange table read error"	Conversion table read error occurred in double-byte or single-byte code conversion.	Select Error from the Help menu to view the system error code, and then check the operating system document for error details.
-683	"Code conversion : Exchange table I/O error"	Conversion table I/O error occurred in double-byte or single-byte code conversion.	Select Error from the Help menu to view the system error code, and then check the operating system document for error details.

Error Code	Error Message	Description	Action
-684	"Code conversion : Unmatched exchange kind and exchange table error"	Type of conversion does not match the code conversion table in double-byte or single-byte code conversion.	Please check the code conversion table.
-685	Code conversion : Broken exchange table error"	Conversion table area is broken in double-byte or single-byte code conversion.	Use ccnv to display and check the contents of the conversion table.
-686	"Code conversion : Memory allocate error"	Memory allocation failed during double-byte or single-byte code conversion.	Select Error from the Help menu to view the system error code, and then check the operating system document for error details.
-687	"Code conversion : Broken environment area error"	Environment area is broken in double-byte or single-byte code conversion.	Please confirm the FCU configuration is correct.
-688	"Code conversion : Exchange length error"	Conversion length error found during double-byte or single-byte code conversion (Field size to convert was 0).	Please check the Field Definition file.
-689	"Code conversion : Exchange code read/set non area error"	Area to refer/set code to convert was not specified in double-byte or single-byte code conversion.	Please confirm the FCU configuration is correct.
-690	"Code conversion : Other error"	Unexpected error occurred during double-byte or single-byte code conversion.	Please check the Field Definition file and Edit Option file.
-691	"Conflicting with input data"	Could not perform conversion because conversion mode conflicts with input data.	Please check input data and the Edit Option file.
-693	"Edit option file : Wrong type of code conversion in the 1 byte code conversion"	Single-byte code conversion in Edit Option file contains a wrong type of code conversion.	Please check the Edit Option file.
-694	"Edit option file : Wrong replacement code for undefined 1 byte character in the 1 byte code conversion"	Single-byte code conversion in Edit Option file contains a wrong replacement code for undefined single-byte characters.	Please check the Edit Option file.
-695	"Edit option file : Directory error for 2 byte code conversion in the 2 byte code conversion"	Table directory not specified for double-byte code conversion in the Edit Option file.	Please check the Edit Option file.
-696	"Edit option file : Directory error for 1 byte code conversion in the 1 byte code conversion"	Table directory not specified for single-byte code conversion in the Edit Option file.	Please check the Edit Option file.
-697	"Edit option file : Information space error"	Information not found in the Edit Option file.	Please check the Edit Option file and enter conversion information as necessary.
-698	"Field definition file : Information space error"	Field information not found in the Field Definition file.	Please check the Field Definition file and enter field information as necessary.

Error Code	Error Message	Description	Action
-700	"Memory allocate error"	Cannot allocate memory for extraction of field information.	Select Error from the Help menu to view the system error code, and then check the operating system document for error details.
-701	"Edit option file : Wrong 1 byte padding code in the 2 byte code conversion"	Double-byte code conversion in the Edit Option file contains a wrong single-byte field padding code.	Please check the Edit Option file.
-702	"Edit option file : Wrong 2 byte padding code in the 2 byte code conversion"	Double-byte code conversion in the Edit Option file contains a wrong double-byte field padding code.	Please check the Edit Option file.
-703	"Edit option file : Wrong 1 byte padding code in the 1 byte code conversion"	Single-byte code conversion in the Edit Option file contains a wrong single-byte field padding code.	Please check the Edit Option file.
-704	"Edit option file : Exchange option exclusive error"	Exclusive error occurred for conversion mode of the Edit Option file.	Please check conversion mode parameter option in Edit Option file.
-705	"Memory allocate error"	Cannot allocate memory for field information sub table.	Select Error from the Help menu to view the system error code, and then check the operating system document for error details.
-706	"Field definition file : Too many data"	Field Definition file is too large.	Please change the Field Definition file so its size is 1,000 lines including the comments.
-707	"Edit option file : Too many data"	Edit Option file is too large ("[]" not found within the first 1,000 lines).	Please check the Edit Option file.
-708	"Edit option file : 1 line data over flow"	Edit Option file has line(s) that are too long.	A line must be within 127 bytes.
-720	"Field define file : Delimiter error"	Delimiter of Field Definition file is wrong.	Please check the delimiters specified in the Field Definition file.
-721	"Field define file : 1 line data over flow"	Field Definition file has line(s) that are too long.	A line must be within 127 bytes.
-722	"Field define file : Total field length unmatched"	The total length of the input fields in the Field Definition file does not match the data record length.	Please check the total length of input fields in the Field Definition file. For fixed-length record, check that total length = record length. For variable-length record, check that total length ≤ record length.
-723	"Field define file : Output field size error"	Output field length of Field Definition file is wrong.	Please check the Field Definition file.
-724	"Field define file : Total output field length error"	The total length of output fields in the Field Definition file is wrong.	Please check the Field Definition file.
-740	"otm:Delimiter check error"	Delimiter of Field Definition file is wrong.	Please check the delimiters specified in the Field Definition file.
-750	"Edit option file : Code exchange kind (Number) error"	Numeric conversion in the Edit Option file contains a wrong type of code conversion.	Please check the Edit Option file.

Error Code	Error Message	Description	Action
-751	"Edit option file : Sign position (Number) error"	Numeric conversion in the Edit Option file contains a wrong sign position.	Please check the Edit Option file.
-752	"Edit option file : Decimal point number (Number) error"	Numeric conversion in the Edit Option file contains a wrong number of decimal digits (must be 0 - 9).	Please check the Edit Option file.
-753	"Edit option file : Zero suppress (Number) error"	Numeric conversion in the Edit Option file contains a wrong zero suppression value.	Please check the Edit Option file.
-754	"Edit option file : Sign plus (Number) error"	Numeric conversion in the Edit Option file contains a wrong plus sign.	Please check the Edit Option file.
-755	"Edit option file : Sign minus (Number) error"	Numeric conversion in the Edit Option file contains a wrong minus sign.	Please check the Edit Option file.
-756	"Edit option file : Zero suppress (TRAN_NON_SUPPRESS) error"	"No zero suppression" is specified for numeric conversion in the Edit Option file.	When placing a sign before effective digits (TRAN_SIGN_V), "No zero suppression" cannot be specified.
-757	"Field define file : Input/Output field size error"	Cannot perform numeric conversion because input/output field length in the Field Definition file is too short.	Please check the Field Definition file.
-758	"Number exchange : Sign position (Number) error with input data"	Cannot perform numeric conversion because sign position in the Edit Option file does not correspond to the input data.	Please check input data and the Edit Option file.
-759	"Number exchange : Decimal point (Number) error with input data"	Cannot perform numeric conversion because number of decimal digits in the Edit Option file does not correspond to the input data.	Please check input data and the Edit Option file.
-760	"Number exchange : Input data (Number) error"	Cannot perform numeric conversion due to wrong input data.	Please check input data.
-761	"Edit option file : All space (Number) error"	Numeric conversion in Edit Option file contains a wrong all-space field.	Please check the Edit Option file.
-780	"License of Code Converter: It does not have the license."	Do not have the license of Code Converter.	Please input the license key of Code Converter.
-781	"License of Code Converter: It expired." T	Code Converter license expired.	Please input the license key of Code Converter again.

Calling the Support Center

If you need to call the Hitachi Data Systems Support Center, make sure to provide as much information about the problem as possible, including the circumstances surrounding the error or failure and the exact content of any messages displayed on the mainframe and/or open-system hosts. Please collect the following information before you call for technical support:

- Error codes: FCU error code, FAL error code, SYS error code. Use the FCU GUI to check recent error information (**Help-Error** command for UNIX, **View-Error information** command for NT).
- FCU parameters: direction (mto or otm), input and output files, and FCU options (code conversion, padding, delimiter, empty file, RDW, VSE record).
- FX volume definition file: contents
- FCU parameter definition file (if used): contents
- Command line log (if possible).
- FAL error logs. The FAL logs for UNIX are **/tmp/fal_error** and **/tmp/fal_error.bak**, and **/tmp/fal_dump** and **/tmp/fal_dump.bak**. The FAL logs for Windows 2000/Windows NT systems are **c:\fal_error** and **c:\fal_error.bak**, and **c:\fal_dump** and **c:\fal_dump.bak**.
- Windows 2000/Windows NT systems only: FCU log file (e.g., **fcudata.prm.log**), and Dr. Watson's log file (e.g., **c:\WINDOWS\DRWTSN32.LOG**).
- **Syslog**: error information and other applicable contents

The Hitachi Data Systems customer support staff is available 24 hours a day, seven days a week. If you need technical support, log on to the Hitachi Data Systems Portal for contact information: <https://hdssupport.hds.com>



Edit Option File

This appendix describes the messages and codes found in the Code Converter Edit Options file.

Edit Option File

Table A-1 MTO

Message/Code	Meaning
[KANJI:OPK1]	Conversion mode directions: The definition label header of KANJI:OPK1.
HOSTtoBIG5	It changes into OPEN BIG5 code from an M/F IBM kanji code.
./	Code conversion table exists in ./ directory.
HOSTBIG5	A conversion table called HOSTBIG5.tbl is used.
TRAN_DBLSPACE	A space character is changed into a 2-byte space code.
20	The 1-byte character un-definition is replaced by X'20'.
A140	The 2-byte character un-definition is replaced by X'A140'.
20	At the time of 1-byte/2-byte mixture, if a conversion place domain remains, it will fill up with X'20'.
A140	At the time only of 2-byte character, if a conversion place domain remains, it will fill up with X'A140'.
TRAN_DOUBLE	The field concerned is the field of only a 2-byte character (Chinese character).
[KANJI:OPK2]	Conversion mode directions: The definition label header of KANJI:OPK2.
HOSTtoBIG5	It changes into OPEN BIG5 code from an M/F IBM kanji code.
./	Code conversion table It exists in ./ directory.
HOSTBIG5	A conversion table called HOSTBIG5.tbl is used.
TRAN_EBCDIC TRAN_START_SINGLE TRAN_DBLSPACE	The 1-byte character code in the field concerned is the EBCDIC code. A shift code changes into 1-byte character from a head. A space character is changed into a 2-byte space code.
20	The 1-byte character un-definition is replaced by X'20'.

Message/Code	Meaning
A140	The 2-byte character un-definition is replaced by X'A140'.
20	At the time of 1-byte/2-byte mixture, if a conversion place domain remains, it will fill up with X'20'.
A140	At the time only of 2-byte character, if a conversion place domain remains, it will fill up with X'A140'.
TRAN_MIX	The field concerned is the mixed field of a 2-byte character (Chinese character) and a 1-byte character.
CHAR:OPK4]	Conversion mode directions: The definition label header of CHAR:OPK4.
EBCIBMtoBIG5	It changes into an ASCII code from the EBCDIC code (IBM system).
./	Code conversion table exists in ./ directory.
HOSTBIG5	A conversion table called HOSTBIG5.tbl is used.
20	The 1-byte character un-definition is replaced by X'20'.
20	If a conversion place domain remains, it will fill up with X'20'.
[NUM:OPA1]	Conversion mode directions: The definition label header of NUM:OPA1.
PACKtoCHAR	It changes into character form from the digital data of pack form.
TRAN_SIGN_F	A mark is positioned in a head.
0	The number of beams of a decimal point is specified.
TRAN_NON_SUPPRESS	0 from a head is set to 0 as it is.
TRAN_SIGN_PLUS_C	A plus mark is C.
TRAN_SIGN_MINUS_D	A minus mark is D.
TRAN_ALLSPACE_NORMAL	The oar 0 of input data is changed into 0 as it is.
[NUM:OPA2]	Conversion mode directions: The definition label header of NUM:OPA2.
ZONEtoCHAR	It changes into character form from the digital data of zone form.
TRAN_SIGN_F	A mark is positioned in a head.
0	The number of beams of a decimal point is specified.
TRAN_NON_SUPPRESS	0 from a head is set to 0 as it is.
TRAN_SIGN_PLUS_C	A plus mark is C.
TRAN_SIGN_MINUS_D	A minus mark is D.
TRAN_ALLSPACE_NORMAL	The oar 0 of input data is changed into 0 as it is.

Table A-2 OTM

Message/Code	Meaning
[KANJI:OPK6]	Conversion mode directions: The definition label header of KANJI:OPK6.
BIG5toHOST	It changes into an M/F IBM kanji code from OPEN BIG5 code.
./	Code conversion table exists in ./ directory.
BIG5HOST	A conversion table called BIG5HOST.tbl is used.
TRAN_DBLSPACE	A space character is changed into a 2-byte space code.
40	The 1-byte character un-definition is replaced by X'40'.
4040	The 2-byte character un-definition is replaced by X'4040'.
40	At the time of 1-byte/2-byte mixture, if a conversion place domain remains, it will fill up with X'40'.
4040	At the time only of 2-byte character, if a conversion place domain remains, it will fill up with X'4040'.
TRAN_DOUBLE	The field concerned is the field of only a 2-byte character (Chinese character).
[KANJI:OPK7]	Conversion mode directions: The definition label header of KANJI:OPK7.
BIG5toHOST	It changes into an M/F IBM kanji code from OPEN BIG5 code. Code conversion table It exists in ./ directory.
BIG5HOST	A conversion table called BIG5HOST.tbl is used.
TRAN_EBCDIC TRAN_START_SINGLE TRAN_DBLSPACE	The 1-byte character code in the field concerned is the EBCDIC code. A shift code changes into 1-byte character from a head. A space character is changed into a 2-byte space code.
40	The 1-byte character un-definition is replaced by X'40'.
4040	The 2-byte character un-definition is replaced by X'4040'.
40	At the time of 1-byte/2-byte mixture, if a conversion place domain remains, it will fill up with X'40'.
4040	At the time only of 2-byte character, if a conversion place domain remains, it will fill up with X'4040'.
TRAN_MIX	The field concerned is the mixed field of a 2-byte character (Chinese character) and a 1-byte character.
[CHAR:OPK9]	Conversion mode directions: The definition label header of CHAR:OPK9.
BIG5toEBCIBM	It changes into the EBCDIC code (IBM system) from an ASCII code.
./	Code conversion table exists in ./ directory.
BIG5HOST	A conversion table called BIG5HOST.tbl is used.
40	The 1-byte character un-definition is replaced by X'40'.
40	If a conversion place domain remains, it will fill up with X'40'.
[NUM:OPA6]	Conversion mode directions: The definition label header of NUM:OPA6.

Message/Code	Meaning
CHARtoPACK	Character formal data is changed into the digital data of pack form.
TRAN_SIGN_F	The mark of input data is in a head.
0	The number of beams of the decimal point of input data is specified.
TRAN_NON_SUPPRESS	0 from a head is set to 0 as it is.
TRAN_SIGN_PLUS_C	A plus mark is C.
TRAN_SIGN_MINUS_D	A minus mark is D.
TRAN_ALLSPACE_NORMAL	The oar 0 of input data is changed into 0 as it is.
[NUM:OPA7]	Conversion mode directions: The definition label header of NUM:OPA7.
CHARtoZONE	Character formal data is changed into zone form digital data.
TRAN_SIGN_F	The mark of input data is in a head.
0	The number of beams of the input data decimal point is specified.
TRAN_NON_SUPPRESS	0 from a head is set to 0 as it is.
TRAN_SIGN_PLUS_C	A plus mark is C.
TRAN_SIGN_MINUS_D	A minus mark is D.
TRAN_ALLSPACE_NORMAL	The oar 0 of input data is changed into 0 as it is.
[]	End indicator.



HOSTBIG5

This appendix provides an example of a Code Conversion table and a table of EBCDIC to ASCII conversion values.

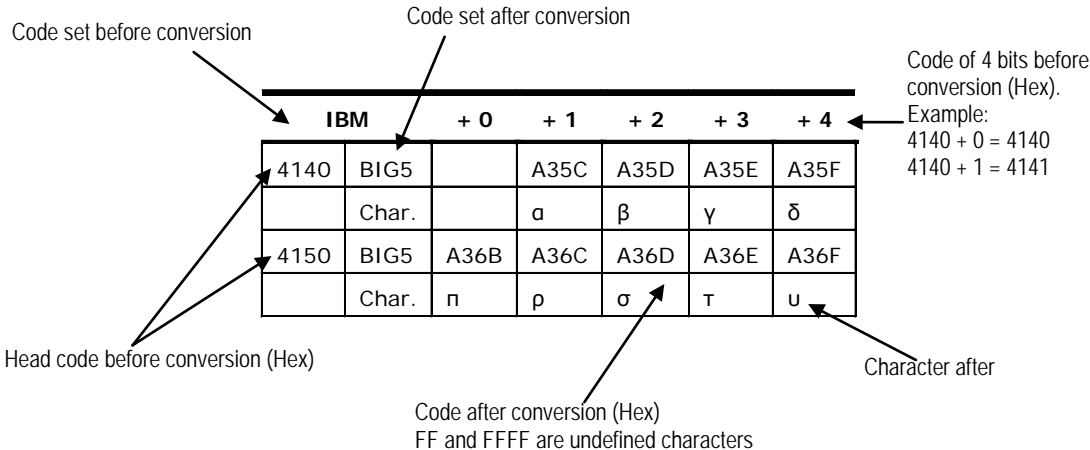

Characters in the conversion table are contained Microsoft standard character sets and different from mainframe characters.

Figure B- 1 Example of Code Conversion Table Contents

Table B- 1 EBCDIC à ASCII Conversion Table

EBCDIC		+ 0	+ 1	+ 2	+ 3	+ 4	+ 5	+ 6	+ 7	+ 8	+ 9	+ A	+ B	+ C	+ D	+ E	+ F
00	ASCII	00	01	02	03	FF	09	FF	7F	FF	FF	FF	0B	0C	0D	0E	0F
	Char.	NUL	SOH	STX	ETX		HT		DEL				VT	NP	CR	SO	SI
10	ASCII	10	11	12	13	FF	0A	08	FF	18	19	FF	FF	1C	1D	1E	1F
	Char.	DLE	DC1	DC2	DC3		NL	BS		CAN	EM			FS	GS	RS	US
20	ASCII	FF	FF	FF	FF	FF	0A	17	1B	FF	FF	FF	FF	FF	05	06	07
	Char.						NL	ETB	ESC						ENQ	ACK	BEL
30	ASCII	FF	FF	16	FF	FF	FF	FF	04	FF	FF	FF	FF	14	15	FF	1A
	Char.			SYN					EOT					DC4	NAK		SUB
40	ASCII	20	FF	FF	FF	FF	FF	FF	FF	FF	FF	FF	2E	3C	28	2B	7C
	Char.	SP											.	<	(+	
50	ASCII	26	FF	FF	FF	FF	FF	FF	FF	FF	FF	21	24	2A	29	3B	FF
	Char.	&										!	\$	*)	;	
60	ASCII	2D	2F	FF	FF	FF	FF	FF	FF	FF	FF	FF	2C	25	5F	3E	3F
	Char.	-	/										,	%	_	>	?
70	ASCII	FF	FF	FF	FF	FF	FF	FF	FF	FF	60	3A	23	40	27	3D	22
	Char.										`	:	#	@	'	=	"
80	ASCII	FF	61	62	63	64	65	66	67	68	69	FF	FF	FF	FF	FF	FF
	Char.		a	b	c	d	e	f	g	h	i						
90	ASCII	FF	6A	6B	6C	6D	6E	6F	70	71	72	FF	FF	FF	FF	FF	FF
	Char.		j	k	l	m	n	o	p	q	r						
A0	ASCII	FF	7E	73	74	75	76	77	78	79	7A	FF	FF	FF	FF	FF	FF
	Char.		~	s	t	u	v	w	x	y	z						
B0	ASCII	5E	FF	FF	FF	FF	FF	FF	FF	FF	FF	5B	5D	FF	FF	FF	FF
	Char.	^										[]				
C0	ASCII	7B	41	42	43	44	45	46	47	48	49	FF	FF	FF	FF	FF	FF
	Char.	{	A	B	C	D	E	F	G	H	I						
D0	ASCII	7D	4A	4B	4C	4D	4E	4F	50	51	52	FF	FF	FF	FF	FF	FF
	Char.	}	J	K	L	M	N	O	P	Q	R						
E0	ASCII	5C	FF	53	54	55	56	57	58	59	5A	FF	FF	FF	FF	FF	FF
	Char.	\		S	T	U	V	W	X	Y	Z						
F0	ASCII	30	31	32	33	34	35	36	37	38	39	FF	FF	FF	FF	FF	FF
	Char.	0	1	2	3	4	5	6	7	8	9						

Table B- 2 ASCII à EBCDIC Conversion Table

ASCII		+ 0	+ 1	+ 2	+ 3	+ 4	+ 5	+ 6	+ 7	+ 8	+ 9	+ A	+ B	+ C	+D	+ E	+ F
00	EBCDIC	00	01	02	03	37	2D	2E	2F	16	05	15	0B	0C	0D	FF	FF
	Char.	NUL	SOH	STX	ETX	EOT	ENQ	ACK	BEL	BS	HT	LF	VT	FF	CR	SO	SI
10	EBCDIC	10	11	12	13	3C	3D	32	26	18	19	3F	27	1C	1D	1E	1F
	Char.	DLE	DC1	DC2	DC3	DC4	NAK	SYN	ETB	CAN	EM	SUB	ESC	FS	GS	RS	US
20	EBCDIC	40	5A	7F	7B	5B	6C	50	7D	4D	5D	5C	4E	6B	60	4B	61
	Char.	SP	!	"	#	\$	%	&	'	()	*	+	,	-	.	/
30	EBCDIC	F0	F1	F2	F3	F4	F5	F6	F7	F8	F9	7A	5E	4C	7E	6E	6F
	Char.	0	1	2	3	4	5	6	7	8	9	:	;	<	=	>	?
40	EBCDIC	7C	C1	C2	C3	C4	C5	C6	C7	C8	C9	D1	D2	D3	D4	D5	D6
	Char.	@	A	B	C	D	E	F	G	H	I	J	K	L	M	N	O
50	EBCDIC	D7	D8	D9	E2	E3	E4	E5	E6	E7	E8	E9	BA	E0	BB	B0	6D
	Char.	P	Q	R	S	T	U	V	W	X	Y	Z	[\]	^	_
60	EBCDIC	79	81	82	83	84	85	86	87	88	89	91	92	93	94	95	96
	Char.	`	a	b	c	d	e	f	g	h	i	j	k	l	m	n	o
70	EBCDIC	97	98	99	A2	A3	A4	A5	A6	A7	A8	A9	C0	4F	D0	A1	07
	Char.	p	q	r	s	t	u	v	w	x	y	z	{		}	~	
80	EBCDIC	FF	FF	FF	FF	FF	FF	FF	FF	FF	FF	FF	FF	FF	FF	FF	FF
	Char.																
90	EBCDIC	FF	FF	FF	FF	FF	FF	FF	FF	FF	FF	FF	FF	FF	FF	FF	FF
	Char.																
A0	EBCDIC	FF	FF	FF	FF	FF	FF	FF	FF	FF	FF	FF	FF	FF	FF	FF	FF
	Char.																
B0	EBCDIC	FF	FF	FF	FF	FF	FF	FF	FF	FF	FF	FF	FF	FF	FF	FF	FF
	Char.																
C0	EBCDIC	FF	FF	FF	FF	FF	FF	FF	FF	FF	FF	FF	FF	FF	FF	FF	FF
	Char.																
D0	EBCDIC	FF	FF	FF	FF	FF	FF	FF	FF	FF	FF	FF	FF	FF	FF	FF	FF
	Char.																
E0	EBCDIC	FF	FF	FF	FF	FF	FF	FF	FF	FF	FF	FF	FF	FF	FF	FF	FF
	Char.																
f0	EBCDIC	FF	FF	FF	FF	FF	FF	FF	FF	FF	FF	FF	FF	FF	FF	FF	FF
	Char.																

Table B- 3 IBM à Big5 Conversion Table

IBM		+ 0	+ 1	+ 2	+ 3	+ 4	+ 5	+ 6	+ 7	+ 8	+ 9	+ A	+ B	+ C	+ D	+ E	+ F
4140	BIG5		A35C	A35D	A35E	A35F	A360	A361	A362	A363	A364	A365	A366	A367	A368	A369	A36A
	Char.		α	β	γ	δ	ε	ζ	η	θ	ι	κ	λ	μ	ν	ξ	ο
4150	BIG5	A36B	A36C	A36D	A36E	A36F	A370	A371	A372	A373	FFFF	FFFF	FFFF	FFFF	FFFF	FFFF	FFFF
	Char.	π	ρ	σ	τ	υ	φ	χ	ψ	ω							
4160	BIG5	FFFF	A344	A345	A346	A347	A348	A349	A34A	A34B	A34C	A34D	A34E	A34F	A350	A351	A352
	Char.		A	B	Γ	Δ	E	Z	H	Θ	I	K	Λ	M	N	Ξ	O
4170	BIG5	A353	A354	A355	A356	A357	A358	A359	A35A	A35B	FFFF	FFFF	FFFF	FFFF	FFFF	FFFF	FFFF
	Char.	Π	P	Σ	T	Υ	Φ	X	Ψ	Ω							
4180	BIG5	FFFF	FFFF	FFFF	FFFF	FFFF	FFFF	FFFF	FFFF	FFFF	FFFF	FFFF	FFFF	FFFF	FFFF	FFFF	FFFF
	Char.																
4190	BIG5	FFFF	FFFF	FFFF	FFFF	FFFF	FFFF	FFFF	FFFF	FFFF	FFFF	FFFF	FFFF	FFFF	FFFF	FFFF	FFFF
	Char.																
41A0	BIG5	FFFF	FFFF	FFFF	FFFF	FFFF	FFFF	FFFF	FFFF	FFFF	FFFF	FFFF	FFFF	FFFF	FFFF	FFFF	FFFF
	Char.																
41B0	BIG5	FFFF	FFFF	FFFF	FFFF	FFFF	FFFF	FFFF	FFFF	FFFF	FFFF	FFFF	FFFF	FFFF	FFFF	FFFF	FFFF
	Char.																
41C0	BIG5	FFFF	FFFF	FFFF	FFFF	FFFF	FFFF	FFFF	FFFF	FFFF	FFFF	FFFF	FFFF	FFFF	FFFF	FFFF	FFFF
	Char.																
41D0	BIG5	FFFF	FFFF	FFFF	FFFF	FFFF	FFFF	FFFF	FFFF	FFFF	FFFF	FFFF	FFFF	FFFF	FFFF	FFFF	FFFF
	Char.																
41E0	BIG5	FFFF	FFFF	FFFF	FFFF	FFFF	FFFF	FFFF	FFFF	FFFF	FFFF	FFFF	FFFF	FFFF	FFFF	FFFF	FFFF
	Char.																
41F0	BIG5	FFFF	A2B9	A2BA	A2BB	A2BC	A2BD	A2BE	A2BF	A2C0	A2C1	A2C2	FFFF	FFFF	FFFF		
	Char.		I	II	III	IV	V	VI	VII	VIII	IX	X					

Table B-3 IBM à Big5 Conversion Table (continued)

IBM		+ 0	+ 1	+ 2	+ 3	+ 4	+ 5	+ 6	+ 7	+ 8	+ 9	+ A	+ B	+ C	+ D	+ E	+ F
4240	BIG5		FFFF	FFFF	FFFF	FFFF	FFFF	FFFF	FFFF	FFFF	FFFF	A247	A144	A1D5	A15D	A1CF	A1FD
	Char.											£	.	<	(+	
4250	BIG5	A1AE	FFFF	FFFF	FFFF	FFFF	FFFF	FFFF	FFFF	FFFF	FFFF	A149	A244	FFFF	A15E	A146	FFFF
	Char.	&										!	¥)	:	
4260	BIG5	A1D0	A1FE	FFFF	FFFF	FFFF	FFFF	FFFF	FFFF	FFFF	FFFF	FFFF	A141	A248	A1C4	A1D6	A148
	Char.	—	/										,	%	_	>	?
4270	BIG5	FFFF	FFFF	FFFF	FFFF	FFFF	FFFF	FFFF	FFFF	FFFF	A1AB	A147	A1AD	A249	FFFF	A1D7	FFFF
	Char.										`	:	#	@		=	
4280	BIG5		A2E9	A2EA	A2EB	A2EC	A2ED	A2EE	A2EF	A2F0	A2F1	FFFF	FFFF	FFFF	FFFF	FFFF	FFFF
	Char.		a	b	c	d	e	f	g	h	i						
4290	BIG5	FFFF	A2F2	A2F3	A2F4	A2F5	A2F6	A2F7	A2F8	A2F9	A2FA	FFFF	FFFF	FFFF	FFFF	FFFF	FFFF
	Char.		j	k	l	m	n	o	p	q	r						
42A0	BIG5	FFFF	A1C2	A2FB	A2FC	A2FD	A2FE	A340	A341	A342	A343	FFFF	FFFF	FFFF	FFFF	FFFF	FFFF
	Char.		-	s	t	u	v	w	x	y	z						
42B0	BIG5	FFFF	FFFF	FFFF	FFFF	FFFF	FFFF	FFFF	FFFF	FFFF	FFFF	FFFF	FFFF	FFFF	FFFF	FFFF	FFFF
	Char.																
42C0	BIG5	A161	A2CF	A2D0	A2D1	A2D2	A2D3	A2D4	A2D5	A2D6	A2D7	FFFF	FFFF	FFFF	FFFF	FFFF	FFFF
	Char.	{	A	B	C	D	E	F	G	H	I						
42D0	BIG5	A162	A2D8	A2D9	A2DA	A2DB	A2DC	A2DD	A2DE	A2DF	A2E0	FFFF	FFFF	FFFF	FFFF	FFFF	FFFF
	Char.	}	J	K	L	M	N	O	P	Q	R						
42E0	BIG5	A243	FFFF	A2E1	A2E2	A2E3	A2E4	A2E5	A2E6	A2E7	A2E8	FFFF	FFFF	FFFF	FFFF	FFFF	FFFF
	Char.	\$		S	T	U	V	W	X	Y	Z						
42F0	BIG5	A2AF	A2B0	A2B1	A2B2	A2B3	A2B4	A2B5	A2B6	A2B7	A2B8	FFFF	FFFF	FFFF	FFFF		
	Char.	0	1	2	3	4	5	6	7	8	9						

Table B-3 IBM à Big5 Conversion Table (continued)

IBM		+ 0	+ 1	+ 2	+ 3	+ 4	+ 5	+ 6	+ 7	+ 8	+ 9	+ A	+ B	+ C	+ D	+ E	+ F
4340	BIG5		A143	A175	A176	A142	A145	FFFF	FFFF	FFFF	FFFF	A246	FFFF	FFFF	FFFF	FFFF	FFFF
	Char.		。	「	」	、	・					¢					
4350	BIG5	FFFF	FFFF	FFFF	FFFF	FFFF	FFFF	FFFF	FFFF	FFFF	FFFF	FFFF	FFFF	FFFF	FFFF	FFFF	FFFF
	Char.																
4360	BIG5	FFFF	FFFF	FFFF	FFFF	FFFF	FFFF	FFFF	FFFF	FFFF	FFFF	FFFF	FFFF	FFFF	FFFF	FFFF	FFFF
	Char.																
4370	BIG5	FFFF	FFFF	FFFF	FFFF	FFFF	FFFF	FFFF	FFFF	FFFF	FFFF	FFFF	FFFF	FFFF	FFFF	FFFF	FFFF
	Char.																
4380	BIG5		FFFF	FFFF	FFFF	FFFF	FFFF	FFFF	FFFF	FFFF	FFFF	FFFF	FFFF	FFFF	FFFF	FFFF	FFFF
	Char.																
4390	BIG5	FFFF	FFFF	FFFF	FFFF	FFFF	FFFF	FFFF	FFFF	FFFF	FFFF	FFFF	FFFF	FFFF	FFFF	FFFF	FFFF
	Char.																
43A0	BIG5	FFFF	A1E3	FFFF	FFFF	FFFF	FFFF	FFFF	FFFF	FFFF	FFFF	FFFF	FFFF	FFFF	FFFF	FFFF	FFFF
	Char.		~														
43B0	BIG5	FFFF	FFFF	FFFF	FFFF	FFFF	FFFF	FFFF	FFFF	FFFF	FFFF	FFFF	FFFF	FFFF	FFFF	FFFF	FFFF
	Char.																
43C0	BIG5	FFFF	FFFF	FFFF	FFFF	FFFF	FFFF	FFFF	FFFF	FFFF	FFFF	FFFF	FFFF	FFFF	FFFF	FFFF	FFFF
	Char.																
43D0	BIG5	FFFF	FFFF	FFFF	FFFF	FFFF	FFFF	FFFF	FFFF	FFFF	FFFF	FFFF	FFFF	FFFF	FFFF	FFFF	FFFF
	Char.																
43E0	BIG5	A240	FFFF	FFFF	FFFF	FFFF	FFFF	FFFF	FFFF	FFFF	FFFF	FFFF	FFFF	FFFF	FFFF	FFFF	FFFF
	Char.	＼															
43F0	BIG5	FFFF	FFFF	FFFF	FFFF	FFFF	FFFF	FFFF	FFFF	FFFF	FFFF	FFFF	FFFF	FFFF	FFFF		
	Char.																

Table B-3 IBM à Big5 Conversion Table (continued)

IBM		+ 0	+ 1	+ 2	+ 3	+ 4	+ 5	+ 6	+ 7	+ 8	+ 9	+ A	+ B	+ C	+ D	+ E	+ F
4440	BIG5		FFFF	A179	A17A	FFFF	FFFF	FFFF	FFFF	FFFF	FFFF	A156	A1D3	A1DA	A1DB	A24A	FFFF
	Char.			『	』							-	±	≠	∞	°C	
4450	BIG5	A1AC	FFFF	FFFF	FFFF	FFFF	FFFF	FFFF	FFFF	FFFF	FFFF	FFFF	FFFF	FFFF	FFFF	FFFF	FFFF
	Char.	'															
4460	BIG5	FFFF	A1A5	A1A7	A165	A171	A16D	A169	A1D8	A1EF	A1F1	A1B1	A1B0	A245	FFFF	FFFF	FFFF
	Char.		'	"	[<	《	【	≦	∴	♂	§	※	〒			
4470	BIG5	FFFF	A1A6	A1A8	A166	A172	A16E	A16A	A1D9	A1EE	A1F0	A1D1	A1D2	A1FC	FFFF	A14C	A14B
	Char.		'	"]	>	》	】	≧	∵	♀	×	÷	//		∴	...
4480	BIG5		FFFF	FFFF	FFFF	FFFF	FFFF	FFFF	FFFF	FFFF	FFFF	FFFF	FFFF	FFFF	FFFF	FFFF	FFFF
	Char.																
4490	BIG5	FFFF	FFFF	FFFF	FFFF	FFFF	FFFF	FFFF	FFFF	FFFF	FFFF	FFFF	FFFF	FFFF	FFFF	FFFF	FFFF
	Char.																
44A0	BIG5	FFFF	FFFF	FFFF	FFFF	FFFF	FFFF	FFFF	FFFF	FFFF	FFFF	FFFF	FFFF	FFFF	FFFF	FFFF	FFFF
	Char.																
44B0	BIG5	FFFF	FFFF	FFFF	FFFF	FFFF	FFFF	FFFF	FFFF	FFFF	FFFF	FFFF	FFFF	FFFF	FFFF	FFFF	FFFF
	Char.																
44C0	BIG5	FFFF	FFFF	FFFF	FFFF	FFFF	FFFF	FFFF	FFFF	FFFF	FFFF	FFFF	FFFF	FFFF	FFFF	FFFF	FFFF
	Char.																
44D0	BIG5	FFFF	FFFF	FFFF	FFFF	FFFF	FFFF	FFFF	FFFF	FFFF	FFFF	FFFF	FFFF	FFFF	FFFF	FFFF	FFFF
	Char.																
44E0	BIG5	A1B3	A1B4	A1B5	A1B6	A1B7	A1B8	A1B9	A1BA	A1BB	A1BC	A1BD	A1BE	A1BF	A258	FFFF	FFFF
	Char.	◦	●	△	▲	◎	☆	★	◇	◆	□	■	▽	▼	°		
44F0	BIG5	A1F7	A1F6	A1F4	A1F5	FFFF	FFFF	FFFF	FFFF	FFFF	FFFF	FFFF	FFFF	FFFF	FFFF		
	Char.	→	←	↑	↓												

Table B-3 IBM à Big5 Conversion Table (continued)

IBM		+ 0	+ 1	+ 2	+ 3	+ 4	+ 5	+ 6	+ 7	+ 8	+ 9	+ A	+ B	+ C	+ D	+ E	+ F
4540	BIG5		A2C3	A2C4	A2C5	A2C6	A2C7	A2C8	A2C9	A2CA	A2CB	A2CC	A2CD	A2CE	FFFF	FFFF	FFFF
	Char.					义	𠄎	𠄏	𠄐	𠄑	𠄒	十	卅	卅			
4550	BIG5	FFFF	A3BC	A3BD	A3BE	A3BF	A3BB	A374	A375	A376	A377	A378	A379	A37A	A37B	A37C	A37D
	Char.		-	˘	˙	˚	˛	ㄅ	ㄆ	ㄇ	ㄏ	ㄏ	ㄏ	ㄏ	ㄏ	ㄏ	ㄏ
4560	BIG5	A37E	A3A1	A3A2	A3A3	A3A4	A3A5	A3A6	A3A7	A3A8	A3A9	A3AA	A3AB	A3AC	A3AD	A3AE	A3AF
	Char.	ㄉ	ㄊ	ㄋ	ㄌ	ㄍ	ㄎ	ㄏ	ㄏ	ㄏ	ㄏ	ㄏ	ㄏ	ㄏ	ㄏ	ㄏ	ㄏ
4570	BIG5	A3B0	A3B1	A3B2	A3B3	A3B4	A3B5	A3B6	A3B7	A3B8	A3B9	A3BA	FFFF	FFFF	FFFF	FFFF	FFFF
	Char.	ㄏ	ㄏ	ㄏ	ㄏ	ㄏ	ㄏ	ㄏ	ㄏ	ㄏ	ㄏ	ㄏ					
4580	BIG5		FFFF	FFFF	FFFF	FFFF	FFFF	FFFF	FFFF	FFFF	FFFF	FFFF	FFFF	FFFF	FFFF	FFFF	FFFF
	Char.																
4590	BIG5	FFFF	FFFF	FFFF	FFFF	FFFF	FFFF	FFFF	FFFF	FFFF	FFFF	FFFF	FFFF	FFFF	FFFF	FFFF	FFFF
	Char.																
45A0	BIG5	FFFF	FFFF	FFFF	FFFF	FFFF	FFFF	FFFF	FFFF	FFFF	FFFF	FFFF	FFFF	FFFF	FFFF	FFFF	FFFF
	Char.																
45B0	BIG5	FFFF	FFFF	FFFF	FFFF	FFFF	FFFF	FFFF	FFFF	FFFF	FFFF	FFFF	FFFF	FFFF	FFFF	FFFF	FFFF
	Char.																
45C0	BIG5	FFFF	FFFF	FFFF	FFFF	FFFF	FFFF	FFFF	FFFF	FFFF	FFFF	FFFF	FFFF	FFFF	FFFF	FFFF	FFFF
	Char.																
45D0	BIG5	FFFF	FFFF	FFFF	FFFF	FFFF	FFFF	FFFF	FFFF	FFFF	FFFF	FFFF	FFFF	FFFF	FFFF	FFFF	FFFF
	Char.																
45E0	BIG5	FFFF	FFFF	FFFF	FFFF	FFFF	FFFF	FFFF	FFFF	FFFF	FFFF	FFFF	FFFF	FFFF	FFFF	FFFF	FFFF
	Char.																
45F0	BIG5	FFFF	FFFF	FFFF	FFFF	FFFF	FFFF	FFFF	FFFF	FFFF	FFFF	FFFF	FFFF	FFFF	FFFF		
	Char.																

Table B-3 IBM à Big5 Conversion Table (continued)

IBM		+ 0	+ 1	+ 2	+ 3	+ 4	+ 5	+ 6	+ 7	+ 8	+ 9	+ A	+ B	+ C	+ D	+ E	+ F
4640	BIG5		FFFF	FFFF	FFFF	FFFF	FFFF	FFFF	FFFF	FFFF	FFFF	FFFF	FFFF	FFFF	FFFF	FFFF	FFFF
	Char.																
4650	BIG5	FFFF	FFFF	FFFF	FFFF	FFFF	FFFF	FFFF	FFFF	FFFF	FFFF	FFFF	FFFF	FFFF	FFFF	FFFF	FFFF
	Char.																
4660	BIG5	A262	A263	A264	A265	A266	A267	A268	A269	A26A	A26B	A26C	A26D	A26E	A26F	A270	A271
	Char.	—	—	—	—	—	—	—	—								†
4670	BIG5	A272	A273	A274	A275	A276	A277	A278	A279	A27A	A27B	A27C	A27D	A27E	A2A1	A2A2	A2A3
	Char.	⊥	⊥	⊥	⊥	⊥	⊥	⊥	⊥	⊥	⊥	⊥	⊥	⊥	⊥	⊥	⊥
4680	BIG5		A2A4	A2A5	A2A6	A2A7	A2A8	A2A9	A2AA	A2AB	A2AC	A2AD	A2AE	FFFF	FFFF	FFFF	FFFF
	Char.		=	≠	≠	≠	≠	≠	≠	/	\	×					
4690	BIG5	FFFF	FFFF	FFFF	FFFF	FFFF	FFFF	FFFF	FFFF	FFFF	FFFF	FFFF	FFFF	FFFF	FFFF	FFFF	FFFF
	Char.																
46A0	BIG5	A177	A178	A17B	A17C	A16B	A16C	FFFF	A155	A159	A15A	A15B	A15C	A15F	A160	A163	A164
	Char.	⌒	⌒	⌒	⌒	⌒	⌒				-	∞	∞	∞	∞	∞	∞
46B0	BIG5	A167	A168	A16F	A170	A173	A174	FFFF	FFFF	A1AF	A1B2	A1C0	A1C1	FFFF	FFFF	A1C6	A1C7
	Char.	∩	∩	∩	∩	∩	∩			*	"	⊕	%			---	---
46C0	BIG5	A1C8	A1C9	A1CA	A1CB	A1CE	A1D4	A1DC	A1DD	A1E4	A1E5	A1E6	A1E7	A1E8	A1E9	A1EA	A1EB
	Char.	∩	∩	∩	∩	*	√	≡	≡	∩	∩	∩	∩	∩	∩	log	ln
46D0	BIG5	A1EC	A1ED	A1F2	A1F3	A1F8	A1F9	A1FA	A1FB	FFFF	FFFF	A241	A24B	A24F	A250	A251	A252
	Char.	∩	∩	∩	∩	∩	∩	∩	∩			/	°F	mil	mm	cm	km
46E0	BIG5	A253	A254	A255	A256	A257	A150	FFFF	FFFF	FFFF	A1A9	A1AA	FFFF	FFFF	FFFF	FFFF	FFFF
	Char.	KM	mí	mg	kg	cc	·				"	"					

Table B-3 IBM à Big5 Conversion Table (continued)

IBM		+ 0	+ 1	+ 2	+ 3	+ 4	+ 5	+ 6	+ 7	+ 8	+ 9	+ A	+ B	+ C	+ D	+ E	+ F
46F0	BIG5	FFFF	A259	A25A	A25B	A25C	A25D	A25E	A25F	A260	A261	FFFF	FFFF	FFFF	FFFF		
	Char.		尅	專	尊	尋	尌	對	導	小	少						
4740	BIG5		A14A	A14D	A14E	A14F	A151	A152	A153	A154	A157	A158	A17D	A17E	A1A1	A1A2	A1A3
	Char.		:	,	.	.	:	:	?	!		—	()	{	}	[
4750	BIG5	A1A4	A1C3	A1C5	A1CC	A1CD	A1DE	A1DF	A1E0	A1E1	A1E2	A242	A24C	A24D	A24E	FFFF	FFFF
	Char.)	—	—	#	&	+	-	<	>	=	\	\$	%	@		
4760	BIG5	FFFF	FFFF	FFFF	FFFF	FFFF	FFFF	FFFF	FFFF	FFFF	FFFF	FFFF	FFFF	FFFF	FFFF	FFFF	FFFF
	Char.																
4770	BIG5	FFFF	FFFF	FFFF	FFFF	FFFF	FFFF	FFFF	FFFF	FFFF	FFFF	FFFF	FFFF	FFFF	FFFF	FFFF	FFFF
	Char.																
4780	BIG5		FFFF	FFFF	FFFF	FFFF	FFFF	FFFF	FFFF	FFFF	FFFF	FFFF	FFFF	FFFF	FFFF	FFFF	FFFF
	Char.																
4790	BIG5	FFFF	FFFF	FFFF	FFFF	FFFF	FFFF	FFFF	FFFF	FFFF	FFFF	FFFF	FFFF	FFFF	FFFF	FFFF	FFFF
	Char.																
47A0	BIG5	FFFF	FFFF	FFFF	FFFF	FFFF	FFFF	FFFF	FFFF	FFFF	FFFF	FFFF	FFFF	FFFF	FFFF	FFFF	FFFF
	Char.																
47B0	BIG5	FFFF	FFFF	FFFF	FFFF	FFFF	FFFF	FFFF	FFFF	FFFF	FFFF	FFFF	FFFF	FFFF	FFFF	FFFF	FFFF
	Char.																
47C0	BIG5	FFFF	FFFF	FFFF	FFFF	FFFF	FFFF	FFFF	FFFF	FFFF	FFFF	FFFF	FFFF	FFFF	FFFF	FFFF	FFFF
	Char.																
47D0	BIG5	FFFF	FFFF	FFFF	FFFF	FFFF	FFFF	FFFF	FFFF	FFFF	FFFF	FFFF	FFFF	FFFF	FFFF	FFFF	FFFF
	Char.																
47E0	BIG5	FFFF	FFFF	FFFF	FFFF	FFFF	FFFF	FFFF	FFFF	FFFF	FFFF	FFFF	FFFF	FFFF	FFFF	FFFF	FFFF
	Char.																

Table B-3 IBM à Big5 Conversion Table (continued)

IBM		+ 0	+ 1	+ 2	+ 3	+ 4	+ 5	+ 6	+ 7	+ 8	+ 9	+ A	+ B	+ C	+ D	+ E	+ F
47F0	BIG5	FFFF	FFFF	FFFF	FFFF	FFFF	FFFF	FFFF	FFFF	FFFF	FFFF	FFFF	FFFF	FFFF	FFFF		
	Char.																
4840	BIG5		FFFF	FFFF	FFFF	FFFF	FFFF	FFFF	FFFF	FFFF	FFFF	FFFF	FFFF	FFFF	FFFF	FFFF	FFFF
	Char.																
4850	BIG5	FFFF	FFFF	FFFF	FFFF	FFFF	FFFF	FFFF	FFFF	FFFF	FFFF	FFFF	FFFF	FFFF	FFFF	FFFF	FFFF
	Char.																
4860	BIG5	FFFF	FFFF	FFFF	FFFF	FFFF	FFFF	FFFF	FFFF	FFFF	FFFF	FFFF	FFFF	FFFF	FFFF	FFFF	FFFF
	Char.																
4870	BIG5	FFFF	FFFF	FFFF	FFFF	FFFF	FFFF	FFFF	FFFF	FFFF	FFFF	FFFF	FFFF	FFFF	FFFF	FFFF	FFFF
	Char.																
4880	BIG5		FFFF	FFFF	FFFF	FFFF	FFFF	FFFF	FFFF	FFFF	FFFF	FFFF	FFFF	FFFF	FFFF	FFFF	FFFF
	Char.																
4890	BIG5	FFFF	FFFF	FFFF	FFFF	FFFF	FFFF	FFFF	FFFF	FFFF	FFFF	FFFF	FFFF	FFFF	FFFF	FFFF	FFFF
	Char.																
48A0	BIG5	FFFF	FFFF	FFFF	FFFF	FFFF	FFFF	FFFF	FFFF	FFFF	FFFF	FFFF	FFFF	FFFF	FFFF	FFFF	FFFF
	Char.																
48B0	BIG5	FFFF	FFFF	FFFF	FFFF	FFFF	FFFF	FFFF	FFFF	FFFF	FFFF	FFFF	FFFF	FFFF	FFFF	FFFF	FFFF
	Char.																
48C0	BIG5	FFFF	FFFF	FFFF	FFFF	FFFF	FFFF	FFFF	FFFF	FFFF	FFFF	FFFF	FFFF	FFFF	FFFF	FFFF	FFFF
	Char.																
48D0	BIG5	FFFF	FFFF	FFFF	FFFF	FFFF	FFFF	FFFF	FFFF	FFFF	FFFF	FFFF	FFFF	FFFF	FFFF	FFFF	FFFF
	Char.																
48E0	BIG5	FFFF	FFFF	FFFF	FFFF	FFFF	FFFF	FFFF	FFFF	FFFF	FFFF	FFFF	FFFF	FFFF	FFFF	FFFF	FFFF
	Char.																

Table B-3 IBM à Big5 Conversion Table (continued)

IBM		+ 0	+ 1	+ 2	+ 3	+ 4	+ 5	+ 6	+ 7	+ 8	+ 9	+ A	+ B	+ C	+ D	+ E	+ F
48F0	BIG5	FFFF	FFFF	FFFF	FFFF	FFFF	FFFF	FFFF	FFFF	FFFF	FFFF	FFFF	FFFF	FFFF	FFFF		
	Char.																
4940	BIG5		FFFF	FFFF	FFFF	FFFF	FFFF	FFFF	FFFF	FFFF	FFFF	FFFF	FFFF	FFFF	FFFF	FFFF	FFFF
	Char.																
4950	BIG5	FFFF	FFFF	FFFF	FFFF	FFFF	FFFF	FFFF	FFFF	FFFF	FFFF	FFFF	FFFF	FFFF	FFFF	FFFF	FFFF
	Char.																
4960	BIG5	FFFF	FFFF	FFFF	FFFF	FFFF	FFFF	FFFF	FFFF	FFFF	FFFF	FFFF	FFFF	FFFF	FFFF	FFFF	FFFF
	Char.																
4970	BIG5	FFFF	FFFF	FFFF	FFFF	FFFF	FFFF	FFFF	FFFF	FFFF	FFFF	FFFF	FFFF	FFFF	FFFF	FFFF	FFFF
	Char.																
4980	BIG5		FFFF	FFFF	FFFF	FFFF	FFFF	FFFF	FFFF	FFFF	FFFF	FFFF	FFFF	FFFF	FFFF	FFFF	FFFF
	Char.																
4990	BIG5	FFFF	FFFF	FFFF	FFFF	FFFF	FFFF	FFFF	FFFF	FFFF	FFFF	FFFF	FFFF	FFFF	FFFF	FFFF	FFFF
	Char.																
49A0	BIG5	FFFF	FFFF	FFFF	FFFF	FFFF	FFFF	FFFF	FFFF	FFFF	FFFF	FFFF	FFFF	FFFF	FFFF	FFFF	FFFF
	Char.																
49B0	BIG5	FFFF	FFFF	FFFF	FFFF	FFFF	FFFF	FFFF	FFFF	FFFF	FFFF	FFFF	FFFF	FFFF	FFFF	FFFF	FFFF
	Char.																
49C0	BIG5	FFFF	FFFF	FFFF	FFFF	FFFF	FFFF	FFFF	FFFF	FFFF	FFFF	FFFF	FFFF	FFFF	FFFF	FFFF	FFFF
	Char.																
49D0	BIG5	FFFF	FFFF	FFFF	FFFF	FFFF	FFFF	FFFF	FFFF	FFFF	FFFF	FFFF	FFFF	FFFF	FFFF	FFFF	FFFF
	Char.																
49E0	BIG5	FFFF	FFFF	FFFF	FFFF	FFFF	FFFF	FFFF	FFFF	FFFF	FFFF	FFFF	FFFF	FFFF	FFFF	FFFF	FFFF
	Char.																

Table B-3 IBM à Big5 Conversion Table (continued)

IBM		+ 0	+ 1	+ 2	+ 3	+ 4	+ 5	+ 6	+ 7	+ 8	+ 9	+ A	+ B	+ C	+ D	+ E	+ F
49F0	BIG5	FFFF	FFFF	FFFF	FFFF	FFFF	FFFF	FFFF	FFFF	FFFF	FFFF	FFFF	FFFF	FFFF	FFFF		
	Char.																
4C40	BIG5		A440	A441	A442	A443	A444	A445	A446	A447	A448	A449	A44A	A44B	A44C	A44D	A44E
	Char.		一	乙	丁	七	乃	九	了	二	人	儿	入	八	几	刀	刁
4C50	BIG5	A44F	A450	A451	A452	A453	A454	A455	A456	A457	A458	A459	A45A	A45B	A45C	A45D	A45E
	Char.	力	七	十	卜	又	三	下	丈	上	丫	丸	凡	久	么	也	乞
4C60	BIG5	A45F	A460	A461	A462	A463	A464	A465	A466	A467	A468	A469	A46A	A46B	A46C	A46D	A46E
	Char.	于	亡	兀	刃	勺	千	叉	口	士	士	夕	大	女	子	子	孑
4C70	BIG5	A46F	A470	A471	A472	A473	A474	A475	A476	A477	A478	A479	A47A	A47B	A47C	A47D	A47E
	Char.	寸	小	尢	尸	山	川	工	己	巳	巳	巾	干	升	弋	弓	才
4C80	BIG5		A4A1	A4A2	A4A3	A4A4	A4A5	A4A6	A4A7	A4A8	A4A9	A4AA	A4AB	A4AC	A4AD	A4AE	A4AF
	Char.		丑	丐	不	中	丰	丹	之	尹	予	云	井	互	五	亢	仁
4C90	BIG5	A4B0	A4B1	A4B2	A4B3	A4B4	A4B5	A4B6	A4B7	A4B8	A4B9	A4BA	A4BB	A4BC	A4BD	A4BE	A4BF
	Char.	什	仃	仆	仇	仍	今	介	仄	元	允	内	六	兮	公	冗	凶
4CA0	BIG5	A4C0	A4C1	A4C2	A4C3	A4C4	A4C5	A4C6	A4C7	A4C8	A4C9	A4CA	A4CB	A4CC	A4CD	A4CE	A4CF
	Char.	分	切	刈	匀	勾	勿	化	匹	午	升	卅	卞	厄	友	及	反
4CB0	BIG5	A4D0	A4D1	A4D2	A4D3	A4D4	A4D5	A4D6	A4D7	A4D8	A4D9	A4DA	A4DB	A4DC	A4DD	A4DE	A4DF
	Char.	壬	天	夫	太	夭	孔	少	尢	尺	屯	巴	幻	廿	帛	引	心
4CC0	BIG5	A4E0	A4E1	A4E2	A4E3	A4E4	A4E5	A4E6	A4E7	A4E8	A4E9	A4EA	A4EB	A4EC	A4ED	A4EE	A4EF
	Char.	戈	戶	手	扌	支	文	斗	斤	方	日	日	月	木	欠	止	歹
4CD0	BIG5	A4F0	A4F1	A4F2	A4F3	A4F4	A4F5	A4F6	A4F7	A4F8	A4F9	A4FA	A4FB	A4FC	A4FD	A4FE	A540
	Char.	毋	比	毛	氏	水	火	爪	父	爻	片	牙	牛	犬	王	丙	世

Table B-3 IBM à Big5 Conversion Table (continued)

IBM		+ 0	+ 1	+ 2	+ 3	+ 4	+ 5	+ 6	+ 7	+ 8	+ 9	+ A	+ B	+ C	+ D	+ E	+ F
4CE0	BIG5	A541	A542	A543	A544	A545	A546	A547	A548	A549	A54A	A54B	A54C	A54D	A54E	A54F	A550
	Char.	丕	且	丘	主	乍	乏	乎	以	付	仔	仕	他	仗	代	令	仙
4CF0	BIG5	A551	A552	A553	A554	A555	A556	A557	A558	A559	A55A	A55B	A55C	A55D	A55E		
	Char.	仞	充	兄	冉	冊	冬	凹	出	凸	刊	加	功	包	匆		
4D40	BIG5		A55F	A560	A561	A562	A563	A564	A565	A566	A567	A568	A569	A56A	A56B	A56C	A56D
	Char.		北	匪	仟	半	弁	卡	占	卯	卮	去	可	古	右	召	叮
4D50	BIG5	A56E	A56F	A570	A571	A572	A573	A574	A575	A576	A577	A578	A579	A57A	A57B	A57C	A57D
	Char.	叩	叨	叮	司	叵	叫	另	只	史	叱	台	句	叭	叻	四	囚
4D60	BIG5	A57E	A5A1	A5A2	A5A3	A5A4	A5A5	A5A6	A5A7	A5A8	A5A9	A5AA	A5AB	A5AC	A5AD	A5AE	A5AF
	Char.	外	央	失	奴	奶	孕	它	尼	巨	巧	左	市	布	平	幼	弁
4D70	BIG5	A5B0	A5B1	A5B2	A5B3	A5B4	A5B5	A5B6	A5B7	A5B8	A5B9	A5BA	A5BB	A5BC	A5BD	A5BE	A5BF
	Char.	弘	弗	必	戊	打	扔	扒	扑	斥	旦	朮	本	未	末	札	正
4D80	BIG5		A5C0	A5C1	A5C2	A5C3	A5C4	A5C5	A5C6	A5C7	A5C8	A5C9	A5CA	A5CB	A5CC	A5CD	A5CE
	Char.		母	民	氐	永	汁	汀	汜	犯	玄	玉	瓜	瓦	甘	生	用
4D90	BIG5	A5CF	A5D0	A5D1	A5D2	A5D3	A5D4	A5D5	A5D6	A5D7	A5D8	A5D9	A5DA	A5DB	A5DC	A5DD	A5DE
	Char.	曳	田	由	甲	申	疋	白	皮	皿	目	矛	矢	石	示	禾	穴
4DA0	BIG5	A5DF	A5E0	A5E1	A5E2	A5E3	A5E4	A5E5	A5E6	A5E7	A5E8	A5E9	A5EA	A5EB	A5EC	A5ED	A5EE
	Char.	立	丞	丟	兵	兵	乩	互	交	亦	亥	仿	伉	伙	伊	佚	伍
4DB0	BIG5	A5EF	A5F0	A5F1	A5F2	A5F3	A5F4	A5F5	A5F6	A5F7	A5F8	A5F9	A5FA	A5FB	A5FC	A5FD	A5FE
	Char.	伐	休	伏	仲	件	任	仰	仇	份	企	伋	光	兕	兆	先	全
4DC0	BIG5	A640	A641	A642	A643	A644	A645	A646	A647	A648	A649	A64A	A64B	A64C	A64D	A64E	A64F
	Char.	共	再	冰	列	刑	划	刎	刖	劣	甸	匡	匠	印	危	吉	吏

Table B-3 IBM à Big5 Conversion Table (continued)

IBM		+ 0	+ 1	+ 2	+ 3	+ 4	+ 5	+ 6	+ 7	+ 8	+ 9	+ A	+ B	+ C	+ D	+ E	+ F
4DD0	BIG5	A650	A651	A652	A653	A654	A655	A656	A657	A658	A659	A65A	A65B	A65C	A65D	A65E	A65F
	Char.	同	吊	吐	吁	吋	各	向	名	合	吃	后	吆	吒	因	回	团
4DE0	BIG5	A660	A661	A662	A663	A664	A665	A666	A667	A668	A669	A66A	A66B	A66C	A66D	A66E	A66F
	Char.	圳	地	在	圭	圪	圪	圪	夙	多	夷	夸	妄	奸	妃	好	她
4DF0	BIG5	A670	A671	A672	A673	A674	A675	A676	A677	A678	A679	A67A	A67B	A67C	A67D		
	Char.	如	灼	字	存	宇	守	宅	安	寺	尖	屹	州	帆	井		
4E40	BIG5		A67E	A6A1	A6A2	A6A3	A6A4	A6A5	A6A6	A6A7	A6A8	A6A9	A6AA	A6AB	A6AC	A6AD	A6AE
	Char.		年	式	弛	忙	忖	戎	戎	戎	成	扣	扛	托	收	早	旨
4E50	BIG5	A6AF	A6B0	A6B1	A6B2	A6B3	A6B4	A6B5	A6B6	A6B7	A6B8	A6B9	A6BA	A6BB	A6BC	A6BD	A6BE
	Char.	旬	旭	曲	曳	有	朽	朴	朱	朵	次	此	死	氛	汝	汗	汗
4E60	BIG5	A6BF	A6C0	A6C1	A6C2	A6C3	A6C4	A6C5	A6C6	A6C7	A6C8	A6C9	A6CA	A6CB	A6CC	A6CD	A6CE
	Char.	江	池	汐	汕	污	汛	洑	汛	灰	牟	牝	百	竹	米	糸	缶
4E70	BIG5	A6CF	A6D0	A6D1	A6D2	A6D3	A6D4	A6D5	A6D6	A6D7	A6D8	A6D9	A6DA	A6DB	A6DC	A6DD	A6DE
	Char.	羊	羽	老	考	而	耒	耳	聿	肉	肋	肌	臣	自	至	臼	舌
4E80	BIG5		A6DF	A6E0	A6E1	A6E2	A6E3	A6E4	A6E5	A6E6	A6E7	A6E8	A6E9	A6EA	A6EB	A6EC	A6ED
	Char.		舛	舟	艮	色	艾	虫	血	行	衣	西	阡	串	亨	位	住
4E90	BIG5	A6EE	A6EF	A6F0	A6F1	A6F2	A6F3	A6F4	A6F5	A6F6	A6F7	A6F8	A6F9	A6FA	A6FB	A6FC	A6FD
	Char.	佇	佗	倭	伴	佛	何	估	佐	佑	伽	伺	伸	佃	佔	似	但
4EA0	BIG5	A6FE	A740	A741	A742	A743	A744	A745	A746	A747	A748	A749	A74A	A74B	A74C	A74D	A74E
	Char.	佣	作	你	伯	低	伶	余	佝	佈	佚	兌	克	免	兵	冶	冷
4EB0	BIG5	A74F	A750	A751	A752	A753	A754	A755	A756	A757	A758	A759	A75A	A75B	A75C	A75D	A75E
	Char.	别	判	利	刪	創	劫	助	努	劬	匣	即	卵	吝	吭	吞	吾
4EC0	BIG5	A75F	A760	A761	A762	A763	A764	A765	A766	A767	A768	A769	A76A	A76B	A76C	A76D	A76E
	Char.	否	呖	吧	呆	呢	吳	呈	呂	君	吩	告	吹	吻	吸	吮	吵

Table B-3 IBM à Big5 Conversion Table (continued)

IBM		+ 0	+ 1	+ 2	+ 3	+ 4	+ 5	+ 6	+ 7	+ 8	+ 9	+ A	+ B	+ C	+ D	+ E	+ F
4ED0	BIG5	A76F	A770	A771	A772	A773	A774	A775	A776	A777	A778	A779	A77A	A77B	A77C	A77D	A77E
	Char.	呐	吠	吼	呀	吱	含	吟	听	函	困	圃	圃	坊	坑	址	坍
4EE0	BIG5	A7A1	A7A2	A7A3	A7A4	A7A5	A7A6	A7A7	A7A8	A7A9	A7AA	A7AB	A7AC	A7AD	A7AE	A7AF	A7B0
	Char.	均	坎	坂	坐	坏	圻	壯	夾	妝	妒	妨	妞	妣	妙	妖	妍
4EF0	BIG5	A7B1	A7B2	A7B3	A7B4	A7B5	A7B6	A7B7	A7B8	A7B9	A7BA	A7BB	A7BC	A7BD	A7BE		
	Char.	姪	妓	妊	妥	孝	孜	孚	幸	完	宋	宏	尪	局	屁		
4F40	BIG5		A7BF	A7C0	A7C1	A7C2	A7C3	A7C4	A7C5	A7C6	A7C7	A7C8	A7C9	A7CA	A7CB	A7CC	A7CD
	Char.		尿	尾	岐	岑	岔	岌	巫	希	序	庇	床	廷	弄	弟	彤
4F50	BIG5	A7CE	A7CF	A7D0	A7D1	A7D2	A7D3	A7D4	A7D5	A7D6	A7D7	A7D8	A7D9	A7DA	A7DB	A7DC	A7DD
	Char.	形	彷彿	役	忘	忌	志	忍	忱	快	忸	忸	戒	我	抄	抗	抖
4F60	BIG5	A7DE	A7DF	A7E0	A7E1	A7E2	A7E3	A7E4	A7E5	A7E6	A7E7	A7E8	A7E9	A7EA	A7EB	A7EC	A7ED
	Char.	技	扶	抉	扭	把	扼	找	批	扳	杼	扯	折	扮	投	抓	抑
4F70	BIG5	A7EE	A7EF	A7F0	A7F1	A7F2	A7F3	A7F4	A7F5	A7F6	A7F7	A7F8	A7F9	A7FA	A7FB	A7FC	A7FD
	Char.	技	改	攻	攸	旱	更	束	李	杏	材	村	杜	杖	祀	杉	杆
4F80	BIG5		A7FE	A840	A841	A842	A843	A844	A845	A846	A847	A848	A849	A84A	A84B	A84C	A84D
	Char.		杠	杓	宗	步	每	求	秉	沙	沁	沈	沉	沅	沛	汪	决
4F90	BIG5	A84E	A84F	A850	A851	A852	A853	A854	A855	A856	A857	A858	A859	A85A	A85B	A85C	A85D
	Char.	沐	汰	沌	汨	冲	沒	汽	沃	汲	汾	汴	沆	汶	洹	沔	泚
4FA0	BIG5	A85E	A85F	A860	A861	A862	A863	A864	A865	A866	A867	A868	A869	A86A	A86B	A86C	A86D
	Char.	沂	灶	灼	災	灸	牢	牡	牠	狄	狂	玖	甬	甫	男	甸	皂
4FB0	BIG5	A86E	A86F	A870	A871	A872	A873	A874	A875	A876	A877	A878	A879	A87A	A87B	A87C	A87D
	Char.	盯	矣	私	秀	秃	究	系	罕	肖	育	肝	肘	肛	肚	育	良
4FC0	BIG5	A87E	A8A1	A8A2	A8A3	A8A4	A8A5	A8A6	A8A7	A8A8	A8A9	A8AA	A8AB	A8AC	A8AD	A8AE	A8AF
	Char.	芒	芋	芍	見	角	言	谷	豆	豕	貝	赤	走	足	身	車	辛

Table B-3 IBM à Big5 Conversion Table (continued)

IBM		+ 0	+ 1	+ 2	+ 3	+ 4	+ 5	+ 6	+ 7	+ 8	+ 9	+ A	+ B	+ C	+ D	+ E	+ F
4FD0	BIG5	A8B0	A8B1	A8B2	A8B3	A8B4	A8B5	A8B6	A8B7	A8B8	A8B9	A8BA	A8BB	A8BC	A8BD	A8BE	A8BF
	Char.	辰	迂	迤	迅	迄	巡	邑	邢	邪	邦	那	酉	采	里	防	阮
4FE0	BIG5	A8C0	A8C1	A8C2	A8C3	A8C4	A8C5	A8C6	A8C7	A8C8	A8C9	A8CA	A8CB	A8CC	A8CD	A8CE	A8CF
	Char.	阱	阪	阮	並	乖	乳	事	些	亞	享	京	佯	依	侍	佳	使
4FF0	BIG5	A8D0	A8D1	A8D2	A8D3	A8D4	A8D5	A8D6	A8D7	A8D8	A8D9	A8DA	A8DB	A8DC	A8DD		
	Char.	佬	供	例	來	侃	佰	併	侈	佩	佻	侖	侷	侸	侹		
5040	BIG5		A8DE	A8DF	A8E0	A8E1	A8E2	A8E3	A8E4	A8E5	A8E6	A8E7	A8E8	A8E9	A8EA	A8EB	A8EC
	Char.		佺	兔	兒	兕	兩	具	其	典	冽	函	刻	券	刷	刺	到
5050	BIG5	A8ED	A8EE	A8EF	A8F0	A8F1	A8F2	A8F3	A8F4	A8F5	A8F6	A8F7	A8F8	A8F9	A8FA	A8FB	A8FC
	Char.	刮	制	剝	劾	劬	卒	協	卓	卑	卦	卷	卸	卹	取	叔	受
5060	BIG5	A8FD	A8FE	A940	A941	A942	A943	A944	A945	A946	A947	A948	A949	A94A	A94B	A94C	A94D
	Char.	味	呵	咖	呷	咕	咀	呻	呷	咄	咒	咆	呼	咐	呱	嗽	和
5070	BIG5	A94E	A94F	A950	A951	A952	A953	A954	A955	A956	A957	A958	A959	A95A	A95B	A95C	A95D
	Char.	咚	呢	周	咋	命	咎	固	埝	珂	坪	柑	坡	坦	坤	坼	夜
5080	BIG5		A95E	A95F	A960	A961	A962	A963	A964	A965	A966	A967	A968	A969	A96A	A96B	A96C
	Char.		奉	奇	奈	奄	奔	妾	妻	委	妹	妮	姑	姆	姐	姍	始
5090	BIG5	A96D	A96E	A96F	A970	A971	A972	A973	A974	A975	A976	A977	A978	A979	A97A	A97B	A97C
	Char.	姓	姊	妯	妳	姒	姘	孟	孤	季	宗	定	官	宜	宙	宛	尚
50A0	BIG5	A97D	A97E	A9A1	A9A2	A9A3	A9A4	A9A5	A9A6	A9A7	A9A8	A9A9	A9AA	A9AB	A9AC	A9AD	A9AE
	Char.	屈	居	屆	岷	岡	岸	岩	岫	岱	岳	帘	帚	帖	帕	帛	帑
50B0	BIG5	A9AF	A9B0	A9B1	A9B2	A9B3	A9B4	A9B5	A9B6	A9B7	A9B8	A9B9	A9BA	A9BB	A9BC	A9BD	A9BE
	Char.	幸	庚	店	府	底	庖	延	弦	弧	弩	往	征	佛	彼	忝	忠
50C0	BIG5	A9BF	A9C0	A9C1	A9C2	A9C3	A9C4	A9C5	A9C6	A9C7	A9C8	A9C9	A9CA	A9CB	A9CC	A9CD	A9CE
	Char.	忽	念	忿	快	怔	怯	忱	怖	怪	怕	怡	性	怩	佛	怛	或

Table B-3 IBM à Big5 Conversion Table (continued)

IBM		+ 0	+ 1	+ 2	+ 3	+ 4	+ 5	+ 6	+ 7	+ 8	+ 9	+ A	+ B	+ C	+ D	+ E	+ F
50D0	BIG5	A9CF	A9D0	A9D1	A9D2	A9D3	A9D4	A9D5	A9D6	A9D7	A9D8	A9D9	A9DA	A9DB	A9DC	A9DD	A9DE
	Char.	戕	虜	戾	所	承	拉	拌	拄	抵	拂	抹	拒	招	披	拓	拔
50E0	BIG5	A9DF	A9E0	A9E1	A9E2	A9E3	A9E4	A9E5	A9E6	A9E7	A9E8	A9E9	A9EA	A9EB	A9EC	A9ED	A9EE
	Char.	拋	拈	抨	抽	押	拐	拙	摺	拍	抵	拚	抱	拘	拖	拗	拆
50F0	BIG5	A9EF	A9F0	A9F1	A9F2	A9F3	A9F4	A9F5	A9F6	A9F7	A9F8	A9F9	A9FA	A9FB	A9FC		
	Char.	拾	掄	放	斧	於	旺	昔	易	昌	昆	昂	明	眇	昏		
5140	BIG5		A9FD	A9FE	AA40	AA41	AA42	AA43	AA44	AA45	AA46	AA47	AA48	AA49	AA4A	AA4B	AA4C
	Char.		昕	昊	昇	服	朋	杭	枋	枕	東	果	杳	杷	枇	枝	林
5150	BIG5	AA4D	AA4E	AA4F	AA50	AA51	AA52	AA53	AA54	AA55	AA56	AA57	AA58	AA59	AA5A	AA5B	AA5C
	Char.	杯	杰	板	枉	松	析	杵	枚	料	杼	杪	杲	欣	武	歧	歿
5160	BIG5	AA5D	AA5E	AA5F	AA60	AA61	AA62	AA63	AA64	AA65	AA66	AA67	AA68	AA69	AA6A	AA6B	AA6C
	Char.	氓	氛	泣	注	泳	沱	泌	泥	河	沽	沾	沼	波	沫	法	泓
5170	BIG5	AA6D	AA6E	AA6F	AA70	AA71	AA72	AA73	AA74	AA75	AA76	AA77	AA78	AA79	AA7A	AA7B	AA7C
	Char.	沸	泄	油	況	沮	泗	泗	決	沿	治	泡	泛	泊	沫	混	涎
5180	BIG5		AA7D	AA7E	AAA1	AAA2	AAA3	AAA4	AAA5	AAA6	AAA7	AAA8	AAA9	AAAA	AAAB	AAAC	AAAD
	Char.		柳	冷	炕	炎	炒	炊	炙	爬	爭	爸	版	牧	物	狀	狎
5190	BIG5	AAAE	AAAF	AAB0	AAB1	AAB2	AAB3	AAB4	AAB5	AAB6	AAB7	AAB8	AAB9	AABA	AABB	AABC	AABD
	Char.	狙	狗	狐	玩	玕	玫	玫	玕	剛	疝	疙	疾	的	孟	盲	直
51A0	BIG5	AABE	AABF	AAC0	AAC1	AAC2	AAC3	AAC4	AAC5	AAC6	AAC7	AAC8	AAC9	AACA	AACB	AACC	AACD
	Char.	知	矽	社	祀	祁	秉	秬	空	穹	竺	糾	罔	羌	非	者	肺
51B0	BIG5	AACE	AACF	AAD0	AAD1	AAD2	AAD3	AAD4	AAD5	AAD6	AAD7	AAD8	AAD9	AADA	AADB	AADC	AADD
	Char.	肥	肢	肱	股	肫	肩	肴	肪	肯	臥	與	舍	芳	芝	芙	芭

Table B-3 IBM à Big5 Conversion Table (continued)

IBM		+ 0	+ 1	+ 2	+ 3	+ 4	+ 5	+ 6	+ 7	+ 8	+ 9	+ A	+ B	+ C	+ D	+ E	+ F
51C0	BIG5	AADE	AADF	AAEO	AAE1	AAE2	AAE3	AAE4	AAE5	AAE6	AAE7	AAE8	AAE9	AAEA	AAEB	AAEC	AAED
	Char.	芽	菱	芹	花	芬	芥	芯	芸	茱	菱	芾	芷	虎	虱	初	表
51D0	BIG5	AAEE	AAEF	AAFO	AAF1	AAF2	AAF3	AAF4	AAF5	AAF6	AAF7	AAF8	AAF9	AAFA	AAFB	AAFC	AAFD
	Char.	軋	迎	返	近	邵	邸	邱	邨	采	金	長	門	阜	陀	阿	阻
51E0	BIG5	AAFE	AB40	AB41	AB42	AB43	AB44	AB45	AB46	AB47	AB48	AB49	AB4A	AB4B	AB4C	AB4D	AB4E
	Char.	附	陂	隹	雨	青	非	亟	亭	亮	信	侵	侯	便	俠	備	俏
51F0	BIG5	AB4F	AB50	AB51	AB52	AB53	AB54	AB55	AB56	AB57	AB58	AB59	AB5A	AB5B	AB5C		
	Char.	保	促	侶	俘	俟	俊	俗	侮	俐	俄	係	俚	俎	俞		
5240	BIG5		AB5D	AB5E	AB5F	AB60	AB61	AB62	AB63	AB64	AB65	AB66	AB67	AB68	AB69	AB6A	AB6B
	Char.		侷	堯	冒	胃	冠	剎	剃	削	前	刺	剋	則	勇	勉	勃
5250	BIG5	AB6C	AB6D	AB6E	AB6F	AB70	AB71	AB72	AB73	AB74	AB75	AB76	AB77	AB78	AB79	AB7A	AB7B
	Char.	勁	葡	南	卻	厚	叛	咬	哀	咨	哎	哉	咸	噴	咳	哇	晒
5260	BIG5	AB7C	AB7D	AB7E	ABA1	ABA2	ABA3	ABA4	ABA5	ABA6	ABA7	ABA8	ABA9	ABAA	ABAB	ABAC	ABAD
	Char.	咽	咪	品	哄	哈	咯	咫	咱	咻	咩	咧	咿	囿	垂	型	垠
5270	BIG5	ABAE	ABAF	ABB0	ABB1	ABB2	ABB3	ABB4	ABB5	ABB6	ABB7	ABB8	ABB9	ABBA	ABBB	ABBC	ABBD
	Char.	垣	垢	城	垮	垓	奕	契	奏	奎	奂	姜	姘	姿	姣	姨	娃
5280	BIG5		ABBE	ABBF	ABC0	ABC1	ABC2	ABC3	ABC4	ABC5	ABC6	ABC7	ABC8	ABC9	ABCA	ABCB	ABCC
	Char.		婁	姪	姚	姦	威	姻	孩	宣	宦	室	客	宥	封	屎	屏
5290	BIG5	ABCD	ABCE	ABCF	ABD0	ABD1	ABD2	ABD3	ABD4	ABD5	ABD6	ABD7	ABD8	ABD9	ABDA	ABDB	ABDC
	Char.	屍	屋	峙	峒	巷	帝	帥	帟	幽	庠	度	建	弈	弭	彥	很
52A0	BIG5	ABDD	ABDE	ABDF	ABE0	ABE1	ABE2	ABE3	ABE4	ABE5	ABE6	ABE7	ABE8	ABE9	ABEA	ABEB	ABEC
	Char.	待	徊	律	徇	後	徉	怒	思	怠	急	怎	怨	恍	恰	恨	恢
52B0	BIG5	ABED	ABEE	ABEF	ABF0	ABF1	ABF2	ABF3	ABF4	ABF5	ABF6	ABF7	ABF8	ABF9	ABFA	ABFB	ABFC
	Char.	恆	恃	恬	恫	恪	恤	扁	拜	挖	按	拼	拭	持	拮	拽	指

Table B-3 IBM à Big5 Conversion Table (continued)

IBM		+ 0	+ 1	+ 2	+ 3	+ 4	+ 5	+ 6	+ 7	+ 8	+ 9	+ A	+ B	+ C	+ D	+ E	+ F
52C0	BIG5	ABFD	ABFE	AC40	AC41	AC42	AC43	AC44	AC45	AC46	AC47	AC48	AC49	AC4A	AC4B	AC4C	AC4D
	Char.	拱	拷	拯	括	拾	控	挑	挂	政	故	斫	施	既	春	昭	映
52D0	BIG5	AC4E	AC4F	AC50	AC51	AC52	AC53	AC54	AC55	AC56	AC57	AC58	AC59	AC5A	AC5B	AC5C	AC5D
	Char.	味	是	星	昨	昱	吟	曷	柿	染	柱	柔	某	東	架	枯	柵
52E0	BIG5	AC5E	AC5F	AC60	AC61	AC62	AC63	AC64	AC65	AC66	AC67	AC68	AC69	AC6A	AC6B	AC6C	AC6D
	Char.	樞	柯	柄	柑	拐	柚	查	枸	柏	柞	柳	桤	桫	柢	柝	柒
52F0	BIG5	AC6E	AC6F	AC70	AC71	AC72	AC73	AC74	AC75	AC76	AC77	AC78	AC79	AC7A	AC7B		
	Char.	歪	殃	殆	段	毒	毗	氟	泉	洋	洲	洪	流	津	洌		
5340	BIG5		AC7C	AC7D	AC7E	ACA1	ACA2	ACA3	ACA4	ACA5	ACA6	ACA7	ACA8	ACA9	ACAA	ACAB	ACAC
	Char.		洱	洞	洗	活	洽	派	洵	洛	泵	涸	洧	洸	洩	洮	洵
5350	BIG5	ACAD	ACAE	ACAF	ACB0	ACB1	ACB2	ACB3	ACB4	ACB5	ACB6	ACB7	ACB8	ACB9	ACBA	ACBB	ACBC
	Char.	洎	洏	炫	為	炳	炬	炯	炭	炸	炮	炤	爰	牲	牯	牴	狩
5360	BIG5	ACBD	ACBE	ACBF	ACC0	ACC1	ACC2	ACC3	ACC4	ACC5	ACC6	ACC7	ACC8	ACC9	ACCA	ACCB	ACCC
	Char.	狠	狡	玷	珊	玻	玲	珍	珀	玳	甚	甬	畏	界	畎	畋	疫
5370	BIG5	ACCD	ACCE	ACCF	ACD0	ACD1	ACD2	ACD3	ACD4	ACD5	ACD6	ACD7	ACD8	ACD9	ACDA	ACDB	ACDC
	Char.	疤	疥	痂	疣	癸	皆	皇	皈	盈	盆	盃	盅	省	眈	相	眉
5380	BIG5		ACDD	ACDE	ACDF	ACE0	ACE1	ACE2	ACE3	ACE4	ACE5	ACE6	ACE7	ACE8	ACE9	ACEA	ACEB
	Char.		看	盾	盼	眇	矜	砂	研	砌	砍	祆	祉	祈	祇	禹	禺
5390	BIG5	ACEC	ACED	ACEE	ACEF	ACF0	ACF1	ACF2	ACF3	ACF4	ACF5	ACF6	ACF7	ACF8	ACF9	ACFA	ACFB
	Char.	科	秒	秋	穿	突	竿	竿	籽	紂	紅	紀	紉	紇	約	紆	缸
53A0	BIG5	ACFC	ACFD	ACFE	AD40	AD41	AD42	AD43	AD44	AD45	AD46	AD47	AD48	AD49	AD4A	AD4B	AD4C
	Char.	美	羿	毫	耐	耍	崙	耶	胖	胥	胚	胃	胃	背	胡	胛	胎
53B0	BIG5	AD4D	AD4E	AD4F	AD50	AD51	AD52	AD53	AD54	AD55	AD56	AD57	AD58	AD59	AD5A	AD5B	AD5C
	Char.	胞	胤	胝	致	舫	苧	范	茅	莖	苛	苦	茄	若	茂	茱	萁

Table B-3 IBM à Big5 Conversion Table (continued)

IBM		+ 0	+ 1	+ 2	+ 3	+ 4	+ 5	+ 6	+ 7	+ 8	+ 9	+ A	+ B	+ C	+ D	+ E	+ F
53C0	BIG5	AD5D	AD5E	AD5F	AD60	AD61	AD62	AD63	AD64	AD65	AD66	AD67	AD68	AD69	AD6A	AD6B	AD6C
	Char.	苗	英	茁	苜	苔	苑	苞	苓	苟	茱	茆	虐	虹	虻	虺	衍
53D0	BIG5	AD6D	AD6E	AD6F	AD70	AD71	AD72	AD73	AD74	AD75	AD76	AD77	AD78	AD79	AD7A	AD7B	AD7C
	Char.	衫	要	觔	計	訂	訃	貞	負	赴	赳	叭	軍	軌	述	迦	迢
53E0	BIG5	AD7D	AD7E	ADA1	ADA2	ADA3	ADA4	ADA5	ADA6	ADA7	ADA8	ADA9	ADAA	ADAB	ADAC	ADAD	ADAE
	Char.	迪	迴	迭	迫	迤	迨	郊	郎	郁	郤	曾	酊	重	門	限	陋
53F0	BIG5	ADAF	ADBO	ADB1	ADB2	ADB3	ADB4	ADB5	ADB6	ADB7	ADB8	ADB9	ADBA	ADBB	ADBC		
	Char.	陌	降	面	革	韋	韭	音	頁	風	飛	食	首	香	乘		
5440	BIG5		ADBD	ADBE	ADBF	ADC0	ADC1	ADC2	ADC3	ADC4	ADC5	ADC6	ADC7	ADC8	ADC9	ADCA	ADCB
	Char.		毫	倌	倍	倣	俯	倦	控	俸	倩	倅	倆	值	借	倚	倒
5450	BIG5	ADCC	ADCD	ADCE	ADCF	ADD0	ADD1	ADD2	ADD3	ADD4	ADD5	ADD6	ADD7	ADD8	ADD9	ADDA	ADDB
	Char.	們	俺	偃	偃	倨	俱	倡	個	候	倘	俳	修	倭	倪	俾	倫
5460	BIG5	ADDC	ADDD	ADDE	ADDF	ADE0	ADE1	ADE2	ADE3	ADE4	ADE5	ADE6	ADE7	ADE8	ADE9	ADEA	ADEB
	Char.	倉	兼	冤	冥	冢	凍	凌	准	凋	剖	剌	剔	剛	剝	匪	卿
5470	BIG5	ADEC	ADED	ADEE	ADEF	ADF0	ADF1	ADF2	ADF3	ADF4	ADF5	ADF6	ADF7	ADF8	ADF9	ADFA	ADFB
	Char.	原	厝	叟	哨	唐	唁	唁	哼	哥	哲	唆	哺	唔	哩	哭	員
5480	BIG5		ADFC	ADFD	ADFE	AE40	AE41	AE42	AE43	AE44	AE45	AE46	AE47	AE48	AE49	AE4A	AE4B
	Char.		唉	哮	哪	哦	唧	唇	哽	唏	圃	圃	埂	埔	埋	埃	培
5490	BIG5	AE4C	AE4D	AE4E	AE4F	AE50	AE51	AE52	AE53	AE54	AE55	AE56	AE57	AE58	AE59	AE5A	AE5B
	Char.	夏	套	奘	奚	娑	娘	娜	娟	娛	媿	姬	娠	娣	媿	娥	媿
54A0	BIG5	AE5C	AE5D	AE5E	AE5F	AE60	AE61	AE62	AE63	AE64	AE65	AE66	AE67	AE68	AE69	AE6A	AE6B
	Char.	娉	孫	庭	宰	害	家	宴	宮	宵	容	宸	射	屑	展	屨	峭

Table B-3 IBM à Big5 Conversion Table (continued)

IBM		+ 0	+ 1	+ 2	+ 3	+ 4	+ 5	+ 6	+ 7	+ 8	+ 9	+ A	+ B	+ C	+ D	+ E	+ F	
54B0	BIG5	AE6C	AE6D	AE6E	AE6F	AE70	AE71	AE72	AE73	AE74	AE75	AE76	AE77	AE78	AE79	AE7A	AE7B	
	Char.	峽	峻	峪	峨	峰	島	崁	峴	差	席	師	庫	庭	座	弱	徒	
54C0	BIG5	AE7C	AE7D	AE7E	AEA1	AEA2	AEA3	AEA4	AEA5	AEA6	AEA7	AEA8	AEA9	AEAA	AEAB	AEAC	AEAD	
	Char.	徑	徐	恙	恣	恥	恐	恕	恭	恩	息	悄	悟	悚	悍	悔	悌	
54D0	BIG5	AEAE	AEAF	AEB0	AEB1	AEB2	AEB3	AEB4	AEB5	AEB6	AEB7	AEB8	AEB9	AEBA	AEBB	AEBC	AEBD	
	Char.	悅	悖	扇	拳	掣	拿	揜	挾	振	捕	搯	捆	捏	捉	挺	捐	
54E0	BIG5	AEBE	AEBF	AECO	AEC1	AEC2	AEC3	AEC4	AEC5	AEC6	AEC7	AEC8	AEC9	AECA	AECB	AECC	AECD	
	Char.	挽	挪	挫	挨	捍	捌	效	糶	料	旁	旅	時	晉	晏	晃	晒	
54F0	BIG5	AECE	AECF	AED0	AED1	AED2	AED3	AED4	AED5	AED6	AED7	AED8	AED9	AEDA	AEDB			
	Char.	晌	暄	晁	書	朔	朕	朗	校	核	案	框	桓	根	桂			
5540	BIG5		AEDC	AEDD	AEDE	AEDF	AEE0	AEE1	AEE2	AEE3	AEE4	AEE5	AEE6	AEE7	AEE8	AEE9	AEEA	
	Char.		桔	栩	梳	栗	桌	桑	栽	柴	桐	桀	格	桃	株	槐	栓	
5550	BIG5	AEEB	AEEC	AEED	AEEE	AEEF	AEF0	AEF1	AEF2	AEF3	AEF4	AEF5	AEF6	AEF7	AEF8	AEF9	AEFA	
	Char.	移	析	殊	殉	殷	氣	氧	氫	氫	氫	氫	泰	浪	涕	消	涇	浦
5560	BIG5	AEFB	AEFC	AEFD	AEFE	AF40	AF41	AF42	AF43	AF44	AF45	AF46	AF47	AF48	AF49	AF4A	AF4B	
	Char.	浸	海	浙	涓	漣	涉	浮	浚	浴	浩	涌	忍	決	涅	滷	涇	
5570	BIG5	AF4C	AF4D	AF4E	AF4F	AF50	AF51	AF52	AF53	AF54	AF55	AF56	AF57	AF58	AF59	AF5A	AF5B	
	Char.	烱	烘	烤	烙	烈	烏	爹	特	狼	狹	猥	狸	狷	玆	班	琉	
5580	BIG5		AF5C	AF5D	AF5E	AF5F	AF60	AF61	AF62	AF63	AF64	AF65	AF66	AF67	AF68	AF69	AF6A	
	Char.		珮	珠	珪	珞	畔	畝	畜	畚	留	疾	病	症	疲	瘡	疽	
5590	BIG5	AF6B	AF6C	AF6D	AF6E	AF6F	AF70	AF71	AF72	AF73	AF74	AF75	AF76	AF77	AF78	AF79	AF7A	
	Char.	疼	疹	痲	疽	皚	皑	益	盍	盍	眩	真	眠	眨	矩	碑	砧	
55A0	BIG5	AF7B	AF7C	AF7D	AF7E	AFA1	AFA2	AFA3	AFA4	AFA5	AFA6	AFA7	AFA8	AFA9	AFAA	AFAB	AFAC	
	Char.	砸	砧	破	砷	砥	砭	砧	砧	砲	祕	祐	祠	崇	祖	神	祝	

Table B-3 IBM à Big5 Conversion Table (continued)

IBM		+ 0	+ 1	+ 2	+ 3	+ 4	+ 5	+ 6	+ 7	+ 8	+ 9	+ A	+ B	+ C	+ D	+ E	+ F
55B0	BIG5	AFAD	AFAE	AFAF	AFB0	AFB1	AFB2	AFB3	AFB4	AFB5	AFB6	AFB7	AFB8	AFB9	AFBA	AFBB	AFBC
	Char.	祇	祚	稗	秣	秧	租	秦	秩	秘	窄	竊	站	筳	笑	粉	紡
55C0	BIG5	AFBD	AFBE	AFBF	AFC0	AFC1	AFC2	AFC3	AFC4	AFC5	AFC6	AFC7	AFC8	AFC9	AFCA	AFCB	AFCC
	Char.	紗	紋	紊	素	索	純	紐	紕	級	紘	納	紙	紛	缺	罟	羔
55D0	BIG5	AFCD	AFCE	AFCF	AFD0	AFD1	AFD2	AFD3	AFD4	AFD5	AFD6	AFD7	AFD8	AFD9	AFDA	AFDB	AFDC
	Char.	翹	翁	耆	耘	耕	耙	耗	耽	耿	眈	脂	胰	脅	胭	胴	脆
55E0	BIG5	AFDD	AFDE	AFDF	AFE0	AFE1	AFE2	AFE3	AFE4	AFE5	AFE6	AFE7	AFE8	AFE9	AFEA	AFEB	AFEC
	Char.	胸	膈	脈	能	脊	胼	膀	臭	臭	昏	舐	航	舫	舩	般	芻
55F0	BIG5	AFED	AFEE	AFEF	AFF0	AFF1	AFF2	AFF3	AFF4	AFF5	AFF6	AFF7	AFF8	AFF9	AFFA		
	Char.	茫	荒	荔	荊	茸	荐	草	茵	茵	荏	茲	茹	茶	茗		
5640	BIG5		AFFB	AFFC	AFFD	AFFE	B040	B041	B042	B043	B044	B045	B046	B047	B048	B049	B04A
	Char.		荀	茱	茈	荃	虔	蚊	蚪	蚪	蚤	蚩	蚌	蚣	蚶	衰	衷
5650	BIG5	B04B	B04C	B04D	B04E	B04F	B050	B051	B052	B053	B054	B055	B056	B057	B058	B059	B05A
	Char.	袁	袂	枉	祇	記	訐	討	訃	訕	訕	託	訓	訖	訐	訑	豈
5660	BIG5	B05B	B05C	B05D	B05E	B05F	B060	B061	B062	B063	B064	B065	B066	B067	B068	B069	B06A
	Char.	豺	豹	財	貢	起	躬	軒	軻	軻	辱	送	逆	迷	退	迺	迴
5670	BIG5	B06B	B06C	B06D	B06E	B06F	B070	B071	B072	B073	B074	B075	B076	B077	B078	B079	B07A
	Char.	逃	追	遁	迸	邕	郡	郝	郢	酒	配	酌	釘	針	釧	釜	針
5680	BIG5		B07B	B07C	B07D	B07E	B0A1	B0A2	B0A3	B0A4	B0A5	B0A6	B0A7	B0A8	B0A9	BOAA	BOAB
	Char.		閃	院	陣	陡	陞	陝	除	陘	陞	隻	飢	馬	骨	高	鬥
5690	BIG5	B0AC	BOAD	BOAE	BOAF	BOB0	BOB1	BOB2	BOB3	BOB4	BOB5	BOB6	BOB7	BOB8	BOB9	BOBA	BOBB
	Char.	鬲	鬼	乾	僭	偽	停	假	僂	僭	做	偉	健	偶	僂	僭	偵
56A0	BIG5	B0BC	BOBD	BOBE	BOBF	BOC0	BOC1	BOC2	BOC3	BOC4	BOC5	BOC6	BOC7	BOC8	BOC9	BOCA	BOCB
	Char.	側	偷	偏	倏	儻	儻	兜	冕	鳳	剪	副	勒	務	勒	動	匍

Table B-3 IBM à Big5 Conversion Table (continued)

IBM		+ 0	+ 1	+ 2	+ 3	+ 4	+ 5	+ 6	+ 7	+ 8	+ 9	+ A	+ B	+ C	+ D	+ E	+ F
56B0	BIG5	B0CC	B0CD	B0CE	B0CF	B0D0	B0D1	B0D2	B0D3	B0D4	B0D5	B0D6	B0D7	B0D8	B0D9	B0DA	B0DB
	Char.	匏	匙	匱	區	區	參	曼	商	啪	啦	啄	啞	啡	嗜	啊	唱
56C0	BIG5	B0DC	B0DD	B0DE	B0DF	B0E0	B0E1	B0E2	B0E3	B0E4	B0E5	B0E6	B0E7	B0E8	B0E9	BOEA	BOEB
	Char.	啖	問	啣	唯	啤	唸	售	啜	唬	啣	喉	啣	啗	圈	國	圍
56D0	BIG5	B0EC	B0ED	B0EE	B0EF	B0F0	B0F1	B0F2	B0F3	B0F4	B0F5	B0F6	B0F7	B0F8	B0F9	BOFA	BOFB
	Char.	域	堅	壘	堆	埠	埠	基	堂	堵	執	培	夠	奢	娶	婁	婉
56E0	BIG5	B0FC	B0FD	B0FE	B140	B141	B142	B143	B144	B145	B146	B147	B148	B149	B14A	B14B	B14C
	Char.	婦	婪	婀	娼	婢	婚	婆	婁	執	寇	寅	寄	寂	宿	密	尉
56F0	BIG5	B14D	B14E	B14F	B150	B151	B152	B153	B154	B155	B156	B157	B158	B159	B15A		
	Char.	專	將	屠	雇	扉	崇	崆	崎	嶺	崖	嶺	崑	崩	崔		
5740	BIG5		B15B	B15C	B15D	B15E	B15F	B160	B161	B162	B163	B164	B165	B166	B167	B168	B169
	Char.		崑	嶺	崑	崗	巢	常	帶	帳	帷	康	庸	庶	庵	庾	張
5750	BIG5	B16A	B16B	B16C	B16D	B16E	B16F	B170	B171	B172	B173	B174	B175	B176	B177	B178	B179
	Char.	強	彗	彬	彩	彫	得	徙	從	徘	御	徠	徇	憑	患	悉	悠
5760	BIG5	B17A	B17B	B17C	B17D	B17E	B1A1	B1A2	B1A3	B1A4	B1A5	B1A6	B1A7	B1A8	B1A9	B1AA	B1AB
	Char.	您	惋	悴	慍	悽	情	悻	悵	惜	悼	惘	惕	惆	惟	悻	惚
5770	BIG5	B1AC	B1AD	B1AE	B1AF	B1B0	B1B1	B1B2	B1B3	B1B4	B1B5	B1B6	B1B7	B1B8	B1B9	B1BA	B1BB
	Char.	惇	戚	戛	扈	掠	控	捲	掖	探	接	捷	捧	掘	措	捱	掩
5780	BIG5		B1BC	B1BD	B1BE	B1BF	B1C0	B1C1	B1C2	B1C3	B1C4	B1C5	B1C6	B1C7	B1C8	B1C9	B1CA
	Char.		掉	掃	掛	捫	推	掄	授	掙	採	掬	排	掏	掀	捻	捩
5790	BIG5	B1CB	B1CC	B1CD	B1CE	B1CF	B1D0	B1D1	B1D2	B1D3	B1D4	B1D5	B1D6	B1D7	B1D8	B1D9	B1DA
	Char.	捨	捺	敝	赦	救	教	敗	啟	敏	敘	敕	敵	斜	斛	斬	族

Table B-3 IBM à Big5 Conversion Table (continued)

IBM		+ 0	+ 1	+ 2	+ 3	+ 4	+ 5	+ 6	+ 7	+ 8	+ 9	+ A	+ B	+ C	+ D	+ E	+ F
57A0	BIG5	B1DB	B1DC	B1DD	B1DE	B1DF	B1E0	B1E1	B1E2	B1E3	B1E4	B1E5	B1E6	B1E7	B1E8	B1E9	B1EA
	Char.	旋	旌	旒	晝	晚	暗	晨	晦	晞	曹	昴	望	梁	梯	梢	梓
57B0	BIG5	B1EB	B1EC	B1ED	B1EE	B1EF	B1F0	B1F1	B1F2	B1F3	B1F4	B1F5	B1F6	B1F7	B1F8	B1F9	B1FA
	Char.	梵	禰	桶	梱	梧	梗	械	挺	棄	梭	柳	梅	樞	條	梨	臬
57C0	BIG5	B1FB	B1FC	B1FD	B1FE	B240	B241	B242	B243	B244	B245	B246	B247	B248	B249	B24A	B24B
	Char.	椋	椋	欲	殺	毫	毳	氫	涎	涼	淳	淙	液	淡	淌	淤	添
57D0	BIG5	B24C	B24D	B24E	B24F	B250	B251	B252	B253	B254	B255	B256	B257	B258	B259	B25A	B25B
	Char.	淺	清	淇	淋	涯	淑	澗	淞	淹	涸	混	淵	淅	淒	渚	涵
57E0	BIG5	B25C	B25D	B25E	B25F	B260	B261	B262	B263	B264	B265	B266	B267	B268	B269	B26A	B26B
	Char.	淚	淫	淘	淪	深	淮	淨	淆	淄	涪	淬	涿	滄	烹	焉	焊
57F0	BIG5	B26C	B26D	B26E	B26F	B270	B271	B272	B273	B274	B275	B276	B277	B278	B279		
	Char.	烽	烯	爽	牽	犁	猜	猛	猖	猓	猓	率	琅	瑯	球		
5840	BIG5		B27A	B27B	B27C	B27D	B27E	B2A1	B2A2	B2A3	B2A4	B2A5	B2A6	B2A7	B2A8	B2A9	B2AA
	Char.		理	現	琍	瓠	瓶	瓷	甜	產	略	蛙	畢	異	疏	痔	痕
5850	BIG5	B2AB	B2AC	B2AD	B2AE	B2AF	B2B0	B2B1	B2B2	B2B3	B2B4	B2B5	B2B6	B2B7	B2B8	B2B9	B2BA
	Char.	疵	痊	瘡	皎	盃	盒	盛	眷	歛	眼	睚	眸	眺	硫	硃	礪
5860	BIG5	B2BB	B2BC	B2BD	B2BE	B2BF	B2C0	B2C1	B2C2	B2C3	B2C4	B2C5	B2C6	B2C7	B2C8	B2C9	B2CA
	Char.	祥	票	祭	移	窰	窰	笠	笨	笛	第	符	笙	笞	笞	粒	粗
5870	BIG5	B2CB	B2CC	B2CD	B2CE	B2CF	B2D0	B2D1	B2D2	B2D3	B2D4	B2D5	B2D6	B2D7	B2D8	B2D9	B2DA
	Char.	粕	絆	絃	統	紮	紹	緋	紕	細	紳	組	累	終	繼	絨	鉢
5880	BIG5		B2DB	B2DC	B2DD	B2DE	B2DF	B2E0	B2E1	B2E2	B2E3	B2E4	B2E5	B2E6	B2E7	B2E8	B2E9
	Char.		羞	矜	翌	翎	習	耜	聊	聆	脯	脬	脣	脣	脣	脣	脣
5890	BIG5	B2EA	B2EB	B2EC	B2ED	B2EE	B2EF	B2F0	B2F1	B2F2	B2F3	B2F4	B2F5	B2F6	B2F7	B2F8	B2F9
	Char.	春	舩	舩	舩	船	莎	莞	莘	莘	莢	莖	莽	莫	莒	莊	莓

Table B-3 IBM à Big5 Conversion Table (continued)

IBM		+ 0	+ 1	+ 2	+ 3	+ 4	+ 5	+ 6	+ 7	+ 8	+ 9	+ A	+ B	+ C	+ D	+ E	+ F
58A0	BIG5	B2FA	B2FB	B2FC	B2FD	B2FE	B340	B341	B342	B343	B344	B345	B346	B347	B348	B349	B34A
	Char.	莉	莠	荷	荻	荼	莆	萇	處	彪	蛇	蛙	蚰	蛄	蚶	蛆	蛋
58B0	BIG5	B34B	B34C	B34D	B34E	B34F	B350	B351	B352	B353	B354	B355	B356	B357	B358	B359	B35A
	Char.	蚱	蚯	蛉	術	袞	袷	被	袒	袖	袍	袋	覓	規	訪	訝	訣
58C0	BIG5	B35B	B35C	B35D	B35E	B35F	B360	B361	B362	B363	B364	B365	B366	B367	B368	B369	B36A
	Char.	訥	許	設	訟	訛	訢	駮	豚	販	責	貫	貨	貪	貧	赧	赦
58D0	BIG5	B36B	B36C	B36D	B36E	B36F	B370	B371	B372	B373	B374	B375	B376	B377	B378	B379	B37A
	Char.	趾	趺	輓	軟	這	遣	通	逗	連	速	逝	逐	逕	逞	造	透
58E0	BIG5	B37B	B37C	B37D	B37E	B3A1	B3A2	B3A3	B3A4	B3A5	B3A6	B3A7	B3A8	B3A9	B3AA	B3AB	B3AC
	Char.	逢	逖	逦	途	郜	郭	都	酗	野	釵	釳	鈞	釧	釨	釩	閉
58F0	BIG5	B3AD	B3AE	B3AF	B3B0	B3B1	B3B2	B3B3	B3B4	B3B5	B3B6	B3B7	B3B8	B3B9	B3BA		
	Char.	陪	陵	陳	陸	陰	啤	陶	陷	陔	雀	雪	零	章	竟		
5940	BIG5		B3BB	B3BC	B3BD	B3BE	B3BF	B3C0	B3C1	B3C2	B3C3	B3C4	B3C5	B3C6	B3C7	B3C8	B3C9
	Char.		頂	頃	魚	烏	鹵	鹿	麥	麻	傢	傍	傅	備	傑	傀	僉
5950	BIG5	B3CA	B3CB	B3CC	B3CD	B3CE	B3CF	B3D0	B3D1	B3D2	B3D3	B3D4	B3D5	B3D6	B3D7	B3D8	B3D9
	Char.	傘	倣	最	凱	割	剝	創	剩	勞	勝	勛	博	厥	營	喀	喧
5960	BIG5	B3DA	B3DB	B3DC	B3DD	B3DE	B3DF	B3E0	B3E1	B3E2	B3E3	B3E4	B3E5	B3E6	B3E7	B3E8	B3E9
	Char.	啼	喊	喝	喘	喂	喜	喪	喔	喇	喋	喃	喳	單	喟	唾	啣
5970	BIG5	B3EA	B3EB	B3EC	B3ED	B3EE	B3EF	B3F0	B3F1	B3F2	B3F3	B3F4	B3F5	B3F6	B3F7	B3F8	B3F9
	Char.	喚	喻	喬	喱	啾	喉	喫	喙	圍	堯	堪	場	堤	堰	報	堡
5980	BIG5		B3FA	B3FB	B3FC	B3FD	B3FE	B440	B441	B442	B443	B444	B445	B446	B447	B448	B449
	Char.		塢	堠	壹	壺	奠	婷	媚	婿	媒	媛	媯	孳	孱	寒	富
5990	BIG5	B44A	B44B	B44C	B44D	B44E	B44F	B450	B451	B452	B453	B454	B455	B456	B457	B458	B459
	Char.	寓	寐	尊	尋	就	嵌	嵐	巖	嵒	巽	幅	帽	幘	幘	幘	廊

Table B-3 IBM à Big5 Conversion Table (continued)

IBM		+ 0	+ 1	+ 2	+ 3	+ 4	+ 5	+ 6	+ 7	+ 8	+ 9	+ A	+ B	+ C	+ D	+ E	+ F
59A0	BIG5	B45A	B45B	B45C	B45D	B45E	B45F	B460	B461	B462	B463	B464	B465	B466	B467	B468	B469
	Char.	廁	廂	殿	弼	彭	復	循	徨	惑	惡	悲	悶	惠	愜	愕	懼
59B0	BIG5	B46A	B46B	B46C	B46D	B46E	B46F	B470	B471	B472	B473	B474	B475	B476	B477	B478	B479
	Char.	愕	愜	側	喘	慨	惱	復	惶	愉	愀	惕	戟	扉	掣	掌	描
59C0	BIG5	B47A	B47B	B47C	B47D	B47E	B4A1	B4A2	B4A3	B4A4	B4A5	B4A6	B4A7	B4A8	B4A9	B4AA	B4AB
	Char.	揀	揩	揉	揆	揆	插	揣	提	握	搥	搨	揮	捶	援	揪	換
59D0	BIG5	B4AC	B4AD	B4AE	B4AF	B4B0	B4B1	B4B2	B4B3	B4B4	B4B5	B4B6	B4B7	B4B8	B4B9	B4BA	B4BB
	Char.	摒	揚	揩	敞	敦	敢	散	斑	斐	斯	普	晰	晴	晶	景	暑
59E0	BIG5	B4BC	B4BD	B4BE	B4BF	B4C0	B4C1	B4C2	B4C3	B4C4	B4C5	B4C6	B4C7	B4C8	B4C9	B4CA	B4CB
	Char.	智	瞭	晷	曾	替	期	朝	棺	棕	棠	棘	棗	椅	棟	棵	森
59F0	BIG5	B4CC	B4CD	B4CE	B4CF	B4D0	B4D1	B4D2	B4D3	B4D4	B4D5	B4D6	B4D7	B4D8	B4D9		
	Char.	棧	棹	棒	棲	棟	棋	棍	植	椒	椎	棉	棚	楮	菜		
5A40	BIG5		B4DA	B4DB	B4DC	B4DD	B4DE	B4DF	B4E0	B4E1	B4E2	B4E3	B4E4	B4E5	B4E6	B4E7	B4E8
	Char.		款	欺	欽	殘	殖	殼	毯	氦	氖	氫	港	游	湍	渡	渲
5A50	BIG5	B4E9	B4EA	B4EB	B4EC	B4ED	B4EE	B4EF	B4F0	B4F1	B4F2	B4F3	B4F4	B4F5	B4F6	B4F7	B4F8
	Char.	湧	湊	渠	渥	渣	減	湛	湘	渤	湖	涇	渭	渦	湯	渴	湍
5A60	BIG5	B4F9	B4FA	B4FB	B4FC	B4FD	B4FE	B540	B541	B542	B543	B544	B545	B546	B547	B548	B549
	Char.	渺	測	湃	渝	渾	滋	溉	渙	灑	滑	涓	湲	湮	湟	焙	焚
5A70	BIG5	B54A	B54B	B54C	B54D	B54E	B54F	B550	B551	B552	B553	B554	B555	B556	B557	B558	B559
	Char.	焦	焰	無	然	煮	焜	牌	犄	犀	猶	猥	猴	猩	珞	琪	琳
5A80	BIG5		B55A	B55B	B55C	B55D	B55E	B55F	B560	B561	B562	B563	B564	B565	B566	B567	B568
	Char.		琢	琥	琵琶	琴	琯	琛	琦	琨	甥	甦	畫	番	痢	痛	
5A90	BIG5	B569	B56A	B56B	B56C	B56D	B56E	B56F	B570	B571	B572	B573	B574	B575	B576	B577	B578
	Char.	瘧	瘰	痘	痞	癩	登	發	皖	皓	皴	盜	晒	短	硝	硬	硯

Table B-3 IBM à Big5 Conversion Table (continued)

IBM		+ 0	+ 1	+ 2	+ 3	+ 4	+ 5	+ 6	+ 7	+ 8	+ 9	+ A	+ B	+ C	+ D	+ E	+ F
5AA0	BIG5	B579	B57A	B57B	B57C	B57D	B57E	B5A1	B5A2	B5A3	B5A4	B5A5	B5A6	B5A7	B5A8	B5A9	B5AA
	Char.	稍	稭	程	稅	稀	窘	窗	窳	童	竣	等	策	筆	筐	筒	答
5AB0	BIG5	B5AB	B5AC	B5AD	B5AE	B5AF	B5B0	B5B1	B5B2	B5B3	B5B4	B5B5	B5B6	B5B7	B5B8	B5B9	B5BA
	Char.	筍	筋	筏	筑	粟	粥	絞	結	絨	絕	紫	絮	絲	絡	給	絢
5AC0	BIG5	B5BB	B5BC	B5BD	B5BE	B5BF	B5C0	B5C1	B5C2	B5C3	B5C4	B5C5	B5C6	B5C7	B5C8	B5C9	B5CA
	Char.	經	絳	善	翔	翕	壘	聒	肅	腕	腔	腋	腑	腎	脹	腆	脾
5AD0	BIG5	B5CB	B5CC	B5CD	B5CE	B5CF	B5D0	B5D1	B5D2	B5D3	B5D4	B5D5	B5D6	B5D7	B5D8	B5D9	B5DA
	Char.	腌	腓	腴	舒	舜	菩	萃	菸	萍	菠	菅	萋	菁	華	菱	菴
5AE0	BIG5	B5DB	B5DC	B5DD	B5DE	B5DF	B5E0	B5E1	B5E2	B5E3	B5E4	B5E5	B5E6	B5E7	B5E8	B5E9	B5EA
	Char.	著	萊	菰	萌	菌	菽	菲	菊	萸	萎	荀	菜	蕞	蕨	菟	虛
5AF0	BIG5	B5EB	B5EC	B5ED	B5EE	B5EF	B5F0	B5F1	B5F2	B5F3	B5F4	B5F5	B5F6	B5F7	B5F8		
	Char.	蛟	蛙	蛭	蛔	蛛	蛤	蚰	蛞	街	裁	裂	袱	罩	視		
5B40	BIG5		B5F9	B5FA	B5FB	B5FC	B5FD	B5FE	B640	B641	B642	B643	B644	B645	B646	B647	B648
	Char.		註	詠	評	詞	証	詰	詔	詛	詐	詆	訴	診	訶	詖	象
5B50	BIG5	B649	B64A	B64B	B64C	B64D	B64E	B64F	B650	B651	B652	B653	B654	B655	B656	B657	B658
	Char.	貂	貯	貼	貳	貽	責	費	賀	責	買	眨	質	貸	越	超	趁
5B60	BIG5	B659	B65A	B65B	B65C	B65D	B65E	B65F	B660	B661	B662	B663	B664	B665	B666	B667	B668
	Char.	跚	距	跋	跚	跑	跌	跛	跹	軻	軸	軼	辜	逮	達	週	逸
5B70	BIG5	B669	B66A	B66B	B66C	B66D	B66E	B66F	B670	B671	B672	B673	B674	B675	B676	B677	B678
	Char.	進	透	鄂	郵	鄉	鄆	酣	酥	量	鈔	鈕	鈣	鈉	鈞	鈍	鈐
5B80	BIG5		B679	B67A	B67B	B67C	B67D	B67E	B6A1	B6A2	B6A3	B6A4	B6A5	B6A6	B6A7	B6A8	B6A9
	Char.		鈇	鈹	閔	閏	開	閑	間	閒	閏	隊	階	隋	陽	隅	隆
5B90	BIG5	B6AA	B6AB	B6AC	B6AD	B6AE	B6AF	B6B0	B6B1	B6B2	B6B3	B6B4	B6B5	B6B6	B6B7	B6B8	B6B9
	Char.	隍	睡	隄	雁	雅	雄	集	雇	雯	雲	韌	項	順	須	飧	飪

Table B-3 IBM à Big5 Conversion Table (continued)

IBM		+ 0	+ 1	+ 2	+ 3	+ 4	+ 5	+ 6	+ 7	+ 8	+ 9	+ A	+ B	+ C	+ D	+ E	+ F
5BA0	BIG5	B6BA	B6BB	B6BC	B6BD	B6BE	B6BF	B6C0	B6C1	B6C2	B6C3	B6C4	B6C5	B6C6	B6C7	B6C8	B6C9
	Char.	飯	鮑	飲	飭	馮	馭	黃	黍	黑	亂	傭	債	傲	傳	僅	傾
5BB0	BIG5	B6CA	B6CB	B6CC	B6CD	B6CE	B6CF	B6D0	B6D1	B6D2	B6D3	B6D4	B6D5	B6D6	B6D7	B6D8	B6D9
	Char.	催	傷	傻	德	僂	剿	剗	剗	募	勦	勤	勢	勦	匯	嗟	噉
5BC0	BIG5	B6DA	B6DB	B6DC	B6DD	B6DE	B6DF	B6E0	B6E1	B6E2	B6E3	B6E4	B6E5	B6E6	B6E7	B6E8	B6E9
	Char.	噪	嗑	嗎	嗜	齋	嗑	嗣	嗑	噁	鳴	喻	嗅	嗆	嗶	嗑	園
5BD0	BIG5	B6EA	B6EB	B6EC	B6ED	B6EE	B6EF	B6F0	B6F1	B6F2	B6F3	B6F4	B6F5	B6F6	B6F7	B6F8	B6F9
	Char.	圓	塞	塑	塘	塗	塚	塔	填	塌	塹	塊	塢	塢	塢	奧	嫁
5BE0	BIG5	B6FA	B6FB	B6FC	B6FD	B6FE	B740	B741	B742	B743	B744	B745	B746	B747	B748	B749	B74A
	Char.	嫉	嫌	媾	媽	媼	媳	嫂	媼	嵩	嵯	幌	幹	廉	廈	弑	彙
5BF0	BIG5	B74B	B74C	B74D	B74E	B74F	B750	B751	B752	B753	B754	B755	B756	B757	B758		
	Char.	徬	微	愚	意	慈	感	想	愛	惹	愁	愈	慎	慌	慄		
5C40	BIG5		B759	B75A	B75B	B75C	B75D	B75E	B75F	B760	B761	B762	B763	B764	B765	B766	B767
	Char.		愠	愠	愠	愧	愠	愠	愠	戡	戡	搓	搾	搞	搪	搭	搽
5C50	BIG5	B768	B769	B76A	B76B	B76C	B76D	B76E	B76F	B770	B771	B772	B773	B774	B775	B776	B777
	Char.	搬	搏	搜	搔	損	搶	搖	搗	構	敬	斟	新	暗	暉	暇	暈
5C60	BIG5	B778	B779	B77A	B77B	B77C	B77D	B77E	B7A1	B7A2	B7A3	B7A4	B7A5	B7A6	B7A7	B7A8	B7A9
	Char.	暖	暄	暘	暘	會	榔	業	楚	楷	楠	楔	極	椰	概	楊	楨
5C70	BIG5	B7AA	B7AB	B7AC	B7AD	B7AE	B7AF	B7B0	B7B1	B7B2	B7B3	B7B4	B7B5	B7B6	B7B7	B7B8	B7B9
	Char.	楫	榜	楓	楹	榆	棟	楣	梏	歇	歲	毀	殿	毓	隄	溢	溯
5C80	BIG5		B7BA	B7BB	B7BC	B7BD	B7BE	B7BF	B7C0	B7C1	B7C2	B7C3	B7C4	B7C5	B7C6	B7C7	B7C8
	Char.		滓	溶	滂	源	溝	滇	滅	溥	溘	溼	溺	溫	滑	準	溜

Table B-3 IBM à Big5 Conversion Table (continued)

IBM		+ 0	+ 1	+ 2	+ 3	+ 4	+ 5	+ 6	+ 7	+ 8	+ 9	+ A	+ B	+ C	+ D	+ E	+ F
5C90	BIG5	B7C9	B7CA	B7CB	B7CC	B7CD	B7CE	B7CF	B7D0	B7D1	B7D2	B7D3	B7D4	B7D5	B7D6	B7D7	B7D8
	Char.	滄	滔	溪	漂	溴	煎	煙	煩	煤	煉	照	煜	煬	煦	煌	煥
5CA0	BIG5	B7D9	B7DA	B7DB	B7DC	B7DD	B7DE	B7DF	B7E0	B7E1	B7E2	B7E3	B7E4	B7E5	B7E6	B7E7	B7E8
	Char.	煞	煨	煨	煨	爺	牒	猷	獅	猿	猾	瑯	瑚	瑕	瑟	瑞	瑁
5CB0	BIG5	B7E9	B7EA	B7EB	B7EC	B7ED	B7EE	B7EF	B7F0	B7F1	B7F2	B7F3	B7F4	B7F5	B7F6	B7F7	B7F8
	Char.	瑋	璫	瑛	瑜	當	畸	癍	瘵	瘵	癩	痲	痺	癢	痲	癩	瘡
5CC0	BIG5	B7F9	B7FA	B7FB	B7FC	B7FD	B7FE	B840	B841	B842	B843	B844	B845	B846	B847	B848	B849
	Char.	盟	睛	睫	睦	眈	督	睹	睪	睬	睜	睥	睨	睽	矮	碎	碰
5CD0	BIG5	B84A	B84B	B84C	B84D	B84E	B84F	B850	B851	B852	B853	B854	B855	B856	B857	B858	B859
	Char.	碗	碘	礫	礪	礪	碑	確	磴	祺	祿	禁	萬	禽	稜	稚	稠
5CE0	BIG5	B85A	B85B	B85C	B85D	B85E	B85F	B860	B861	B862	B863	B864	B865	B866	B867	B868	B869
	Char.	稔	稟	稞	窟	窠	篋	節	筠	筮	筧	梁	粳	粵	經	絹	網
5CF0	BIG5	B86A	B86B	B86C	B86D	B86E	B86F	B870	B871	B872	B873	B874	B875	B876	B877		
	Char.	綁	綏	條	置	罩	罪	署	義	羨	群	聖	聘	肆	肆		
5D40	BIG5		B878	B879	B87A	B87B	B87C	B87D	B87E	B8A1	B8A2	B8A3	B8A4	B8A5	B8A6	B8A7	B8A8
	Char.		臄	腰	腸	脛	腮	腳	腫	腹	腺	腦	舅	艇	蒂	葦	落
5D50	BIG5	B8A9	B8AA	B8AB	B8AC	B8AD	B8AE	B8AF	B8B0	B8B1	B8B2	B8B3	B8B4	B8B5	B8B6	B8B7	B8B8
	Char.	萱	葵	葦	葫	葉	葬	葛	萼	萼	萼	葡	董	葩	葩	葆	虞
5D60	BIG5	B8B9	B8BA	B8BB	B8BC	B8BD	B8BE	B8BF	B8C0	B8C1	B8C2	B8C3	B8C4	B8C5	B8C6	B8C7	B8C8
	Char.	號	蛹	蜓	蜈	蜚	蜀	蛾	蛻	蜂	蟹	蜆	蝟	衙	裘	裔	裙
5D70	BIG5	B8C9	B8CA	B8CB	B8CC	B8CD	B8CE	B8CF	B8D0	B8D1	B8D2	B8D3	B8D4	B8D5	B8D6	B8D7	B8D8
	Char.	補	裘	裝	裡	裊	裕	裊	覩	解	詫	該	詳	試	詩	詰	誇
5D80	BIG5		B8D9	B8DA	B8DB	B8DC	B8DD	B8DE	B8DF	B8E0	B8E1	B8E2	B8E3	B8E4	B8E5	B8E6	B8E7
	Char.		詼	詣	誠	話	誅	詭	詢	詮	詬	詹	諮	訾	訾	豢	豢

Table B-3 IBM à Big5 Conversion Table (continued)

IBM		+ 0	+ 1	+ 2	+ 3	+ 4	+ 5	+ 6	+ 7	+ 8	+ 9	+ A	+ B	+ C	+ D	+ E	+ F
5D90	BIG5	B8E8	B8E9	B8EA	B8EB	B8EC	B8ED	B8EE	B8EF	B8F0	B8F1	B8F2	B8F3	B8F4	B8F5	B8F6	B8F7
	Char.	貉	賊	資	賈	賄	賞	賃	賂	賅	跡	跟	跨	路	跳	蹠	跪
5DA0	BIG5	B8F8	B8F9	B8FA	B8FB	B8FC	B8FD	B8FE	B940	B941	B942	B943	B944	B945	B946	B947	B948
	Char.	跂	跖	躄	較	載	軾	輕	辟	農	運	遊	道	遂	達	逼	違
5DB0	BIG5	B949	B94A	B94B	B94C	B94D	B94E	B94F	B950	B951	B952	B953	B954	B955	B956	B957	B958
	Char.	遯	遇	遏	過	遍	違	逾	遁	鄒	鄔	酬	酪	酪	釉	鈷	鉗
5DC0	BIG5	B959	B95A	B95B	B95C	B95D	B95E	B95F	B960	B961	B962	B963	B964	B965	B966	B967	B968
	Char.	鉞	鉈	鉀	鉉	鉛	鉆	鉤	鉈	鉉	鉊	鉋	鉌	鉍	鉎	鉏	鉑
5DD0	BIG5	B969	B96A	B96B	B96C	B96D	B96E	B96F	B970	B971	B972	B973	B974	B975	B976	B977	B978
	Char.	隘	隔	隕	雍	雋	雉	雊	雷	電	電	零	靖	靴	靶	預	頑
5DE0	BIG5	B979	B97A	B97B	B97C	B97D	B97E	B9A1	B9A2	B9A3	B9A4	B9A5	B9A6	B9A7	B9A8	B9A9	B9AA
	Char.	頓	頊	頌	頌	飼	飴	飽	飾	馳	馱	馴	髡	鳩	麂	鼎	鼓
5DF0	BIG5	B9AB	B9AC	B9AD	B9AE	B9AF	B9B0	B9B1	B9B2	B9B3	B9B4	B9B5	B9B6	B9B7	B9B8		
	Char.	鼠	僧	僮	僥	僖	僦	僚	僕	像	僑	僱	僕	僱	僱	兢	
5E40	BIG5		B9B9	B9BA	B9BB	B9BC	B9BD	B9BE	B9BF	B9C0	B9C1	B9C2	B9C3	B9C4	B9C5	B9C6	B9C7
	Char.		堯	劃	剛	匱	厭	喉	啞	嘛	嘗	嗽	嘔	嘆	嘉	嘍	嘎
5E50	BIG5	B9C8	B9C9	B9CA	B9CB	B9CC	B9CD	B9CE	B9CF	B9D0	B9D1	B9D2	B9D3	B9D4	B9D5	B9D6	B9D7
	Char.	嗽	嘖	啣	嘈	嚙	嚙	團	圖	塵	塾	境	墓	塾	塹	豎	塢
5E60	BIG5	B9D8	B9D9	B9DA	B9DB	B9DC	B9DD	B9DE	B9DF	B9E0	B9E1	B9E2	B9E3	B9E4	B9E5	B9E6	B9E7
	Char.	壽	夥	夢	夤	奪	奩	嫡	娣	嫩	嫗	嫖	嫖	嫖	嫖	寔	寧
5E70	BIG5	B9E8	B9E9	B9EA	B9EB	B9EC	B9ED	B9EE	B9EF	B9F0	B9F1	B9F2	B9F3	B9F4	B9F5	B9F6	B9F7
	Char.	寡	寥	實	素	寢	寢	察	對	屢	嶄	嶄	嶄	幃	幕	幃	幃

Table B-3 IBM à Big5 Conversion Table (continued)

IBM		+ 0	+ 1	+ 2	+ 3	+ 4	+ 5	+ 6	+ 7	+ 8	+ 9	+ A	+ B	+ C	+ D	+ E	+ F
5E80	BIG5		B9F8	B9F9	B9FA	B9FB	B9FC	B9FD	B9FE	BA40	BA41	BA42	BA43	BA44	BA45	BA46	BA47
	Char.		廓	廖	弊	弊	彰	徹	慫	愿	態	慷	慢	慣	慟	慚	慘
5E90	BIG5	BA48	BA49	BA4A	BA4B	BA4C	BA4D	BA4E	BA4F	BA50	BA51	BA52	BA53	BA54	BA55	BA56	BA57
	Char.	慵	截	撤	摘	摔	撤	摸	摟	摺	摺	摧	牽	搥	摻	敲	幹
5EA0	BIG5	BA58	BA59	BA5A	BA5B	BA5C	BA5D	BA5E	BA5F	BA60	BA61	BA62	BA63	BA64	BA65	BA66	BA67
	Char.	旗	旖	暢	暨	暝	榜	榨	榕	槁	榮	楨	構	榛	權	榻	樺
5EB0	BIG5	BA68	BA69	BA6A	BA6B	BA6C	BA6D	BA6E	BA6F	BA70	BA71	BA72	BA73	BA74	BA75	BA76	BA77
	Char.	榴	槐	槍	樹	槌	榦	槩	檣	歎	歌	氫	漳	演	滾	漓	滴
5EC0	BIG5	BA78	BA79	BA7A	BA7B	BA7C	BA7D	BA7E	BAA1	BAA2	BAA3	BAA4	BAA5	BAA6	BAA7	BAA8	BAA9
	Char.	漩	漾	漠	漬	漏	漂	漠	滿	滯	漆	漱	漸	漲	漣	漕	漫
5ED0	BIG5	BAAA	BAAB	BAAC	BAAD	BAAE	BAAF	BAB0	BAB1	BAB2	BAB3	BAB4	BAB5	BAB6	BAB7	BAB8	BAB9
	Char.	潔	澈	漪	滬	漁	滲	滌	滷	熔	熙	煽	熊	熄	熒	爾	犒
5EE0	BIG5	BABA	BABB	BABC	BABD	BABE	BABF	BAC0	BAC1	BAC2	BAC3	BAC4	BAC5	BAC6	BAC7	BAC8	BAC9
	Char.	犖	獄	獐	瑤	瑣	瑪	瑰	瑤	甄	疑	癩	癩	瘋	癩	癩	盡
5EF0	BIG5	BACA	BACB	BACC	BACD	BACE	BACF	BAD0	BAD1	BAD2	BAD3	BAD4	BAD5	BAD6	BAD7		
	Char.	監	瞄	睽	睿	睡	磁	碟	碧	碳	碩	礪	禎	福	禍		
5F40	BIG5		BAD8	BAD9	BADA	BADB	BADC	BADD	BADE	BADF	BAE0	BAE1	BAE2	BAE3	BAE4	BAE5	BAE6
	Char.		種	稱	窪	窩	竭	端	管	箕	箕	筵	算	箝	箝	箝	箝
5F50	BIG5	BAE7	BAE8	BAE9	BAEA	BAEB	BAEC	BAED	BAEE	BAEF	BAF0	BAF1	BAF2	BAF3	BAF4	BAF5	BAF6
	Char.	箇	箏	粹	粽	精	綻	綰	綜	綽	綾	綠	緊	綴	網	網	綺
5F60	BIG5	BAF7	BAF8	BAF9	BAFA	BAFB	BAFC	BAFD	BAFE	BB40	BB41	BB42	BB43	BB44	BB45	BB46	BB47
	Char.	綱	綿	綵	綸	維	緒	緇	綬	罰	翠	翡	翟	聞	聚	肇	腐
5F70	BIG5	BB48	BB49	BB4A	BB4B	BB4C	BB4D	BB4E	BB4F	BB50	BB51	BB52	BB53	BB54	BB55	BB56	BB57
	Char.	膀	膏	膈	膊	腿	膂	臧	臺	與	舔	舞	舡	蓉	蒿	蓆	蓄

Table B-3 IBM à Big5 Conversion Table (continued)

IBM		+ 0	+ 1	+ 2	+ 3	+ 4	+ 5	+ 6	+ 7	+ 8	+ 9	+ A	+ B	+ C	+ D	+ E	+ F
5F80	BIG5		BB58	BB59	BB5A	BB5B	BB5C	BB5D	BB5E	BB5F	BB60	BB61	BB62	BB63	BB64	BB65	BB66
	Char.		蒙	蒞	蒲	蒜	蓋	蒸	蓀	蓓	菟	蒼	蓑	蓊	蜿	蜜	蜻
5F90	BIG5	BB67	BB68	BB69	BB6A	BB6B	BB6C	BB6D	BB6E	BB6F	BB70	BB71	BB72	BB73	BB74	BB75	BB76
	Char.	蝻	蜥	蜴	蚰	蝕	蝮	蝮	裳	褂	裴	裹	裸	製	裨	褚	裯
5FA0	BIG5	BB77	BB78	BB79	BB7A	BB7B	BB7C	BB7D	BB7E	BBA1	BBA2	BBA3	BBA4	BBA5	BBA6	BBA7	BBA8
	Char.	誦	誌	語	誣	認	誠	誓	誤	說	誥	誨	誘	誑	誦	誦	豪
5FB0	BIG5	BBA9	BBAA	BBAB	BBAC	BBAD	BBAE	BBAF	BBB0	BBB1	BBB2	BBB3	BBB4	BBB5	BBB6	BBB7	BBB8
	Char.	狸	貌	賈	賑	賒	赫	趙	趕	踟	輔	輒	輕	輓	辣	遠	邁
5FC0	BIG5	BBB9	BBBA	BBBB	BBBC	BBBD	BBBE	BBBF	BBC0	BBC1	BBC2	BBC3	BBC4	BBC5	BBC6	BBC7	BBC8
	Char.	遜	遣	遙	遞	邇	逦	邈	鄙	鄙	鄞	醇	酸	酷	醅	鉸	銀
5FD0	BIG5	BBC9	BBCA	BBCB	BBCD	BBCD	BBCE	BBCF	BBD0	BBD1	BBD2	BBD3	BBD4	BBD5	BBD6	BBD7	BBD8
	Char.	銅	銘	銖	銘	銓	銜	鉸	鉗	銑	閔	閔	閔	閔	閔	閔	隙
5FE0	BIG5	BBD9	BBDA	BBDB	BBDC	BBDD	BBDE	BBDF	BBE0	BBE1	BBE2	BBE3	BBE4	BBE5	BBE6	BBE7	BBE8
	Char.	障	際	雌	雒	需	艱	鞅	韶	頗	領	颯	颯	餃	餅	餌	餉
5FF0	BIG5	BBE9	BBEA	BBEB	BBEC	BBED	BBEE	BBEF	BBF0	BBF1	BBF2	BBF3	BBF4	BBF5	BBF6		
	Char.	駁	航	骰	髦	魁	魂	鳴	鳶	鳳	麼	鼻	齊	億	儀		
6040	BIG5		BBF7	BBF8	BBF9	BBFA	BBFB	BBFC	BBFD	BBFE	BC40	BC41	BC42	BC43	BC44	BC45	BC46
	Char.		僻	僵	價	儂	儉	儉	儉	凜	劇	劈	劉	劍	劊	總	厲
6050	BIG5	BC47	BC48	BC49	BC4A	BC4B	BC4C	BC4D	BC4E	BC4F	BC50	BC51	BC52	BC53	BC54	BC55	BC56
	Char.	嘍	嘻	嘹	嘲	嘿	嘴	嘩	噓	噎	嘆	噴	嘶	嘯	噤	墀	墟
6060	BIG5	BC57	BC58	BC59	BC5A	BC5B	BC5C	BC5D	BC5E	BC5F	BC60	BC61	BC62	BC63	BC64	BC65	BC66
	Char.	增	墳	墜	墜	墩	播	爽	嬉	嫻	嬋	嫵	嬌	嬌	寮	寬	審
6070	BIG5	BC67	BC68	BC69	BC6A	BC6B	BC6C	BC6D	BC6E	BC6F	BC70	BC71	BC72	BC73	BC74	BC75	BC76
	Char.	寫	層	履	嶝	嶽	幢	幟	幟	幟	廢	廚	廟	廡	廠	廠	彈

Table B-3 IBM à Big5 Conversion Table (continued)

IBM		+ 0	+ 1	+ 2	+ 3	+ 4	+ 5	+ 6	+ 7	+ 8	+ 9	+ A	+ B	+ C	+ D	+ E	+ F
6080	BIG5		BC77	BC78	BC79	BC7A	BC7B	BC7C	BC7D	BC7E	BCA1	BCA2	BCA3	BCA4	BCA5	BCA6	BCA7
	Char.		德	徵	慶	慧	慮	愿	慕	憂	感	慰	愆	慾	懂	憐	憫
6090	BIG5	BCA8	BCA9	BCAA	BCAB	BCAC	BCAD	BCAE	BCAF	BCB0	BCB1	BCB2	BCB3	BCB4	BCB5	BCB6	BCB7
	Char.	憎	慄	憚	慎	樵	撫	戮	摩	摯	辜	撞	撲	撈	撐	撰	撥
60A0	BIG5	BCB8	BCB9	BCBA	BCBB	BCBC	BCBD	BCBE	BCBF	BCC0	BCC1	BCC2	BCC3	BCC4	BCC5	BCC6	BCC7
	Char.	撓	撕	撩	撒	撮	播	撫	撚	攪	擰	擲	撇	敵	敷	數	暮
60B0	BIG5	BCC8	BCC9	BCCA	BCCB	BCCC	BCCD	BCCE	BCCF	BCD0	BCD1	BCD2	BCD3	BCD4	BCD5	BCD6	BCD7
	Char.	暫	暴	暍	樣	樟	柳	椿	樞	標	槽	模	樓	樊	槩	樂	縱
60C0	BIG5	BCD8	BCD9	BCDA	BCDB	BCDC	BCDD	BCDE	BCDF	BCE0	BCE1	BCE2	BCE3	BCE4	BCE5	BCE6	BCE7
	Char.	械	樑	歐	歎	殤	毅	毆	漿	潼	澄	潑	潦	潔	澆	潭	潛
60D0	BIG5	BCE8	BCE9	BCEA	BCEB	BCEC	BCED	BCEE	BCEF	BCF0	BCF1	BCF2	BCF3	BCF4	BCF5	BCF6	BCF7
	Char.	漚	潮	澎	潺	潰	潤	澗	潘	滕	濤	灑	渦	熟	熬	熱	熨
60E0	BIG5	BCF8	BCF9	BCFA	BCFB	BCFC	BCFD	BCFE	BD40	BD41	BD42	BD43	BD44	BD45	BD46	BD47	BD48
	Char.	牖	葦	獎	蕪	瑩	璋	璃	瑾	璫	畿	瘠	痞	瘟	瘤	瘦	瘡
60F0	BIG5	BD49	BD4A	BD4B	BD4C	BD4D	BD4E	BD4F	BD50	BD51	BD52	BD53	BD54	BD55	BD56		
	Char.	癩	皚	皴	盤	瞎	瞇	瞞	瞞	瞞	瞞	磅	確	磊	礪		
6140	BIG5		BD57	BD58	BD59	BD5A	BD5B	BD5C	BD5D	BD5E	BD5F	BD60	BD61	BD62	BD63	BD64	BD65
	Char.		磕	碼	磬	稿	稼	穀	稽	稷	稻	窯	窮	箭	箱	範	箴
6150	BIG5	BD66	BD67	BD68	BD69	BD6A	BD6B	BD6C	BD6D	BD6E	BD6F	BD70	BD71	BD72	BD73	BD74	BD75
	Char.	篆	篇	篁	篳	篥	糊	締	練	緯	緞	絨	緬	緝	編	綠	線
6160	BIG5	BD76	BD77	BD78	BD79	BD7A	BD7B	BD7C	BD7D	BD7E	BDA1	BDA2	BDA3	BDA4	BDA5	BDA6	BDA7
	Char.	緞	緩	緹	緝	緞	緹	罵	罷	羯	翮	耦	膛	膜	膝	膠	膚

Table B-3 IBM à Big5 Conversion Table (continued)

IBM		+ 0	+ 1	+ 2	+ 3	+ 4	+ 5	+ 6	+ 7	+ 8	+ 9	+ A	+ B	+ C	+ D	+ E	+ F
6170	BIG5	BDA8	BDA9	BDAA	BDAB	BDAC	BDAD	BDAE	BDAF	BDB0	BDB1	BDB2	BDB3	BDB4	BDB5	BDB6	BDB7
	Char.	鏢	蔗	蔽	蔚	蓮	蔬	蔭	蔓	茂	蔣	蔡	葡	蓬	蔥	菴	菱
6180	BIG5		BDB8	BDB9	BDBA	BDBB	BDBC	BDBD	BDBE	BDBF	BDC0	BDC1	BDC2	BDC3	BDC4	BDC5	BDC6
	Char.		螂	蝴	蝶	蝠	蝦	蝸	蝨	蝙	蝗	蝌	蟪	衝	衝	褐	複
6190	BIG5	BDC7	BDC8	BDC9	BDCA	BDCB	BDCC	BDCD	BDCE	BDCF	BDD0	BDD1	BDD2	BDD3	BDD4	BDD5	BDD6
	Char.	褒	褫	榆	褊	誼	諒	談	諄	誕	請	諸	課	諉	諂	調	誰
61A0	BIG5	BDD7	BDD8	BDD9	BDDA	Bddb	BDDC	BDDD	BDDE	BDDF	BDE0	BDE1	BDE2	BDE3	BDE4	BDE5	BDE6
	Char.	論	諍	諍	誹	諛	詭	豎	豬	賄	賞	賦	賤	賤	賤	賢	賣
61B0	BIG5	BDE7	BDE8	BDE9	BDEA	BDEB	BDEC	BDED	BDEE	BDEF	BDF0	BDF1	BDF2	BDF3	BDF4	BDF5	BDF6
	Char.	賜	質	賡	赭	趨	趣	蹙	踐	蹶	踢	踏	蹠	脚	蹠	踞	躺
61C0	BIG5	BDF7	BDF8	BDF9	BDFa	BDFB	BDFC	BDFD	BDFE	BE40	BE41	BE42	BE43	BE44	BE45	BE46	BE47
	Char.	輝	輔	輟	輩	輦	輪	輜	輞	輗	適	遮	遼	遭	遷	鄰	鄭
61D0	BIG5	BE48	BE49	BE4A	BE4B	BE4C	BE4D	BE4E	BE4F	BE50	BE51	BE52	BE53	BE54	BE55	BE56	BE57
	Char.	鄧	鄱	醇	醉	醋	醜	鋅	銻	銷	鋪	銻	鋤	鋁	銳	銼	鋒
61E0	BIG5	BE58	BE59	BE5A	BE5B	BE5C	BE5D	BE5E	BE5F	BE60	BE61	BE62	BE63	BE64	BE65	BE66	BE67
	Char.	銀	銓	銓	閭	闕	霄	靈	震	霽	靠	鞍	鞋	鞏	頤	頰	頤
61F0	BIG5	BE68	BE69	BE6A	BE6B	BE6C	BE6D	BE6E	BE6F	BE70	BE71	BE72	BE73	BE74	BE75		
	Char.	颯	養	餓	餒	餘	駝	駐	駟	駝	駑	駑	駑	駑	駑		
6240	BIG5		BE76	BE77	BE78	BE79	BE7A	BE7B	BE7C	BE7D	BE7E	BEA1	BEA2	BEA3	BEA4	BEA5	BEA6
	Char.		髮	髯	鬚	魅	魄	魃	魯	鳩	鴉	缺	麩	麾	黎	墨	齒
6250	BIG5	BEA7	BEA8	BEA9	BEAA	BEAB	BEAC	BEAD	BEAE	BEAF	BEB0	BEB1	BEB2	BEB3	BEB4	BEB5	BEB6
	Char.	儒	儘	僑	債	債	冀	冪	凝	劑	劑	勳	噲	噫	噫	噫	噫

Table B-3 IBM à Big5 Conversion Table (continued)

IBM		+ 0	+ 1	+ 2	+ 3	+ 4	+ 5	+ 6	+ 7	+ 8	+ 9	+ A	+ B	+ C	+ D	+ E	+ F
6260	BIG5	BEB7	BEB8	BEB9	BEBA	BEBB	BEEC	BEBD	BEBE	BEBF	BECO	BEC1	BEC2	BEC3	BEC4	BEC5	BEC6
	Char.	噸	噪	器	嘍	噓	噁	噬	噢	噶	壁	壑	壇	壅	奮	孃	羸
6270	BIG5	BEC7	BEC8	BEC9	BECA	BECB	BECC	BECD	BECE	BECF	BED0	BED1	BED2	BED3	BED4	BED5	BED6
	Char.	學	寰	導	彊	憲	憑	憩	憊	懍	憶	憾	懊	懈	戰	擅	擁
6280	BIG5		BED7	BED8	BED9	BEDA	BEDB	BEDC	BEDD	BEDE	BEDF	BEE0	BEE1	BEE2	BEE3	BEE4	BEE5
	Char.		擋	撻	撼	據	擄	擇	播	操	檢	擒	擔	搥	整	曆	曉
6290	BIG5	BEE6	BEE7	BEE8	BEE9	BEEA	BEEB	BEEC	BEED	BEEE	BEEF	BEF0	BEF1	BEF2	BEF3	BEF4	BEF5
	Char.	暹	暉	曇	瞭	樽	樸	樺	橙	橫	橘	樹	橄	橢	橡	橋	橈
62A0	BIG5	BEF6	BEF7	BEF8	BEF9	BEFA	BEFB	BEFC	BEFD	BEFE	BF40	BF41	BF42	BF43	BF44	BF45	BF46
	Char.	樵	機	橈	欸	歷	斃	濂	澱	澡	濃	澤	濁	澧	澳	激	澹
62B0	BIG5	BF47	BF48	BF49	BF4A	BF4B	BF4C	BF4D	BF4E	BF4F	BF50	BF51	BF52	BF53	BF54	BF55	BF56
	Char.	澶	瀕	澗	澗	熾	熾	熾	燒	燈	燕	烹	燎	燙	爛	燃	燄
62C0	BIG5	BF57	BF58	BF59	BF5A	BF5B	BF5C	BF5D	BF5E	BF5F	BF60	BF61	BF62	BF63	BF64	BF65	BF66
	Char.	獨	璜	璣	璘	璒	璞	瓢	甌	薑	瘡	癩	癩	癩	盧	盥	瞠
62D0	BIG5	BF67	BF68	BF69	BF6A	BF6B	BF6C	BF6D	BF6E	BF6F	BF70	BF71	BF72	BF73	BF74	BF75	BF76
	Char.	瞠	管	磨	磚	磬	磧	禦	積	穎	穆	穌	穆	窺	篙	簍	築
62E0	BIG5	BF77	BF78	BF79	BF7A	BF7B	BF7C	BF7D	BF7E	BFA1	BFA2	BFA3	BFA4	BFA5	BFA6	BFA7	BFA8
	Char.	篤	籟	筭	篩	篋	糕	糖	綫	縑	縑	縛	縣	縞	縑	縑	縑
62F0	BIG5	BFA9	BFAA	BFAB	BFAC	BFAD	BFAE	BFAF	BFBO	BFB1	BFB2	BFB3	BFB4	BFB5	BFB6		
	Char.	罹	羲	翰	翱	翻	耨	膳	膩	膨	臻	興	艘	艙	蕊		
6340	BIG5		BFB7	BFB8	BFB9	BFBA	BFBB	BFBC	BFBD	BFBE	BFBF	BFC0	BFC1	BFC2	BFC3	BFC4	BFC5
	Char.		蕙	蕈	蕨	蕩	蕃	蕉	蕭	蕪	蕪	蕪	螟	螟	螢	融	衡

Table B-3 IBM à Big5 Conversion Table (continued)

IBM		+ 0	+ 1	+ 2	+ 3	+ 4	+ 5	+ 6	+ 7	+ 8	+ 9	+ A	+ B	+ C	+ D	+ E	+ F
6350	BIG5	BFC6	BFC7	BFC8	BFC9	BFCA	BFCB	BFCC	BFCD	BFCE	BFCF	BFD0	BFD1	BFD2	BFD3	BFD4	BFD5
	Char.	褪	褲	襦	襪	襪	親	親	諦	諺	諫	諱	謀	謀	諧	諮	諾
6360	BIG5	BFD6	BFD7	BFD8	BFD9	BFDA	BFDB	BFDC	BFDD	BFDE	BDFD	BFE0	BFE1	BFE2	BFE3	BFE4	BFE5
	Char.	謁	謂	諷	諭	諳	謹	諛	豫	猥	貓	賴	蹄	跋	踴	蹂	踴
6370	BIG5	BFE6	BFE7	BFE8	BFE9	BFEA	BFEB	BFEC	BFED	BFEF	BFEF	BFF0	BFF1	BFF2	BFF3	BFF4	BFF5
	Char.	踵	輻	輯	輸	輳	辨	辦	遵	遴	選	遲	遼	遺	鄴	醒	錠
6380	BIG5		BFF6	BFF7	BFF8	BFF9	BFFA	BFFB	BFFC	BFFD	BFFE	C040	C041	C042	C043	C044	C045
	Char.		錶	鋸	錳	錯	錢	鋼	錫	錄	錚	錐	錦	錡	錕	錮	鎢
6390	BIG5	C046	C047	C048	C049	C04A	C04B	C04C	C04D	C04E	C04F	C050	C051	C052	C053	C054	C055
	Char.	閻	隧	隨	險	雕	霎	霏	霖	霍	霓	霏	靛	靜	靛	鞞	頰
63A0	BIG5	C056	C057	C058	C059	C05A	C05B	C05C	C05D	C05E	C05F	C060	C061	C062	C063	C064	C065
	Char.	頸	頻	頷	頭	頰	頤	餐	館	餞	餽	餽	餽	駭	駢	駱	骸
63B0	BIG5	C066	C067	C068	C069	C06A	C06B	C06C	C06D	C06E	C06F	C070	C071	C072	C073	C074	C075
	Char.	骼	髻	髭	鬩	鮑	鮑	鳩	鴛	鴨	鴿	鴛	默	黔	龍	龜	優
63C0	BIG5	C076	C077	C078	C079	C07A	C07B	C07C	C07D	C07E	COA1	COA2	COA3	COA4	COA5	COA6	COA7
	Char.	償	僂	儲	勵	嘍	嘍	嗜	喘	嚇	噯	壕	歷	壑	壙	嬰	嬪
63D0	BIG5	COA8	COA9	COAA	COAB	COAC	COAD	COAE	COAF	COB0	COB1	COB2	COB3	COB4	COB5	COB6	COB7
	Char.	嫵	孺	慙	屨	嶼	嶺	嶽	嶸	幫	彌	徹	應	懂	懇	儒	懋
63E0	BIG5	COB8	COB9	COBA	COBB	COBC	COBD	COBE	COBF	COC0	COC1	COC2	COC3	COC4	COC5	COC6	COC7
	Char.	戲	戴	擎	擊	擊	擠	擰	擦	擬	擱	擢	擢	斂	斃	曙	曖
63F0	BIG5	COC8	COC9	COCA	COCB	COCC	COCD	COCE	COCF	COD0	COD1	COD2	COD3	COD4	COD5		
	Char.	檀	檔	檄	檢	檜	櫛	櫛	櫛	櫛	櫛	檠	獸	殮	彘		

Table B-3 IBM à Big5 Conversion Table (continued)

IBM		+ 0	+ 1	+ 2	+ 3	+ 4	+ 5	+ 6	+ 7	+ 8	+ 9	+ A	+ B	+ C	+ D	+ E	+ F
6440	BIG5		C0D6	C0D7	C0D8	C0D9	C0DA	C0DB	C0DC	C0DD	C0DE	C0DF	C0E0	C0E1	C0E2	C0E3	C0E4
	Char.		氾	濇	濱	濟	濠	濛	濤	濞	濯	澀	濬	濡	濩	濕	濮
6450	BIG5	C0E5	C0E6	C0E7	C0E8	C0E9	C0EA	C0EB	C0EC	C0ED	C0EE	C0EF	C0F0	C0F1	C0F2	C0F3	C0F4
	Char.	濼	燧	營	變	燦	燥	燭	燬	燴	燵	爵	牆	穉	獲	璩	環
6460	BIG5	C0F5	C0F6	C0F7	C0F8	C0F9	C0FA	C0FB	C0FC	C0FD	C0FE	C140	C141	C142	C143	C144	C145
	Char.	璣	璒	癆	療	癌	盪	瞳	瞪	瞰	瞬	瞧	瞭	矯	磷	磧	磴
6470	BIG5	C146	C147	C148	C149	C14A	C14B	C14C	C14D	C14E	C14F	C150	C151	C152	C153	C154	C155
	Char.	磯	礁	禧	禪	穗	蔭	簇	萋	箴	蓬	藪	篠	糠	糜	糞	糝
6480	BIG5		C156	C157	C158	C159	C15A	C15B	C15C	C15D	C15E	C15F	C160	C161	C162	C163	C164
	Char.		糟	糙	糝	縮	績	繆	縷	縲	縴	縵	總	縱	縲	繁	縲
6490	BIG5	C165	C166	C167	C168	C169	C16A	C16B	C16C	C16D	C16E	C16F	C170	C171	C172	C173	C174
	Char.	縲	縲	縲	縲	縲	縲	翼	翼	聳	聳	聰	聯	聳	臆	臆	膺
64A0	BIG5	C175	C176	C177	C178	C179	C17A	C17B	C17C	C17D	C17E	C1A1	C1A2	C1A3	C1A4	C1A5	C1A6
	Char.	臂	臂	膿	臆	臉	臆	臨	舉	艱	薪	薄	蕾	薜	薑	蕎	薯
64B0	BIG5	C1A7	C1A8	C1A9	C1AA	C1AB	C1AC	C1AD	C1AE	C1AF	C1B0	C1B1	C1B2	C1B3	C1B4	C1B5	C1B6
	Char.	薛	薇	蕘	薊	虧	蟀	蟬	蝗	蟒	蟆	螫	螻	螺	蝸	蟋	虱
64C0	BIG5	C1B7	C1B8	C1B9	C1BA	C1BB	C1BC	C1BD	C1BE	C1BF	C1C0	C1C1	C1C2	C1C3	C1C4	C1C5	C1C6
	Char.	褶	襄	樓	製	覲	謎	謗	謙	講	誑	謠	謝	膳	謚	裕	谿
64D0	BIG5	C1C7	C1C8	C1C9	C1CA	C1CB	C1CC	C1CD	C1CE	C1CF	C1D0	C1D1	C1D2	C1D3	C1D4	C1D5	C1D6
	Char.	幽	賺	賽	購	臆	膊	趨	蹉	蹋	蹈	蹊	轄	輻	轂	輻	輿
64E0	BIG5	C1D7	C1D8	C1D9	C1DA	C1DB	C1DC	C1DD	C1DE	C1DF	C1E0	C1E1	C1E2	C1E3	C1E4	C1E5	C1E6
	Char.	避	遽	還	邁	避	邀	鄆	醕	醞	醜	鍍	鎂	錨	鍵	鍊	鍍
64F0	BIG5	C1E7	C1E8	C1E9	C1EA	C1EB	C1EC	C1ED	C1EE	C1EF	C1F0	C1F1	C1F2	C1F3	C1F4		
	Char.	鍋	錘	鍾	鍬	鍛	鍍	錫	鍔	闕	闕	闕	闕	闕	闕		

Table B-3 IBM à Big5 Conversion Table (continued)

IBM		+ 0	+ 1	+ 2	+ 3	+ 4	+ 5	+ 6	+ 7	+ 8	+ 9	+ A	+ B	+ C	+ D	+ E	+ F	
6540	BIG5		C1F5	C1F6	C1F7	C1F8	C1F9	C1FA	C1FB	C1FC	C1FD	C1FE	C240	C241	C242	C243	C244	
	Char.		隸	雖	霜	霞	鞠	韓	穎	颯	餵	聘	駿	鮮	鮫	鮪	鮭	
6550	BIG5	C245	C246	C247	C248	C249	C24A	C24B	C24C	C24D	C24E	C24F	C250	C251	C252	C253	C254	
	Char.	鴻	鴿	稟	黏	點	黜	勳	黛	鼯	齋	叢	嚙	嚮	壙	壘	壙	
6560	BIG5	C255	C256	C257	C258	C259	C25A	C25B	C25C	C25D	C25E	C25F	C260	C261	C262	C263	C264	
	Char.	彝	憑	戳	擴	擲	擾	攢	擺	撇	搨	斷	曜	朦	檳	檬	櫃	
6570	BIG5	C265	C266	C267	C268	C269	C26A	C26B	C26C	C26D	C26E	C26F	C270	C271	C272	C273	C274	
	Char.	檻	榨	榨	檣	檣	欺	歸	殞	瀉	瀆	濾	瀆	濺	瀑	瀏	燻	
6580	BIG5		C275	C276	C277	C278	C279	C27A	C27B	C27C	C27D	C27E	C2A1	C2A2	C2A3	C2A4	C2A5	
	Char.		燼	燾	燻	獠	獵	壁	璿	甕	癖	癩	癒	瞽	瞿	瞻	臉	
6590	BIG5	C2A6	C2A7	C2A8	C2A9	C2AA	C2AB	C2AC	C2AD	C2AE	C2AF	C2B0	C2B1	C2B2	C2B3	C2B4	C2B5	
	Char.	礎	禮	穉	穢	穢	竄	竅	簫	簧	簪	簞	簞	簡	糧	織	繕	
65A0	BIG5	C2B6	C2B7	C2B8	C2B9	C2BA	C2BB	C2BC	C2BD	C2BE	C2BF	C2C0	C2C1	C2C2	C2C3	C2C4	C2C5	
	Char.	繞	繚	繡	繪	繙	繢	翹	翻	職	聶	臍	臍	舊	藏	薩	藍	
65B0	BIG5	C2C6	C2C7	C2C8	C2C9	C2CA	C2CB	C2CC	C2CD	C2CE	C2CF	C2D0	C2D1	C2D2	C2D3	C2D4	C2D5	
	Char.	藐	藉	薰	齊	臺	薦	蟻	蟬	蟲	蟠	覆	覲	觴	謨	謹	謬	
65C0	BIG5	C2D6	C2D7	C2D8	C2D9	C2DA	C2DB	C2DC	C2DD	C2DE	C2DF	C2E0	C2E1	C2E2	C2E3	C2E4	C2E5	
	Char.	謫	豐	贅	蹙	蹙	蹙	蹙	蹙	蹙	軀	轉	轍	邇	邃	邈	醫	
65D0	BIG5	C2E6	C2E7	C2E8	C2E9	C2EA	C2EB	C2EC	C2ED	C2EE	C2EF	C2F0	C2F1	C2F2	C2F3	C2F4	C2F5	
	Char.	醬	釐	鎔	鎔	鎖	鎔	鎔	鎔	鎔	鎔	鎔	鎔	鎔	鎔	閩	閩	閩
65E0	BIG5	C2F6	C2F7	C2F8	C2F9	C2FA	C2FB	C2FC	C2FD	C2FE	C340	C341	C342	C343	C344	C345	C346	
	Char.	闕	離	雜	雙	雛	雞	雷	鞣	鞣	鞣	靛	額	顏	題	頤	頤	
65F0	BIG5	C347	C348	C349	C34A	C34B	C34C	C34D	C34E	C34F	C350	C351	C352	C353	C354			
	Char.	颯	餽	餽	餽	餽	餽	騎	髀	髀	鬆	魏	魎	魎	鯊			

Table B-3 IBM à Big5 Conversion Table (continued)

IBM		+ 0	+ 1	+ 2	+ 3	+ 4	+ 5	+ 6	+ 7	+ 8	+ 9	+ A	+ B	+ C	+ D	+ E	+ F
6640	BIG5		C355	C356	C357	C358	C359	C35A	C35B	C35C	C35D	C35E	C35F	C360	C361	C362	C363
	Char.		鯉	鯽	條	鯨	鵠	鵠	鵠	黠	鑿	馳	儂	嚙	壞	壘	壘
6650	BIG5	C364	C365	C366	C367	C368	C369	C36A	C36B	C36C	C36D	C36E	C36F	C370	C371	C372	C373
	Char.	寵	龐	廬	愆	懷	懶	憐	攀	攏	曠	曝	櫛	櫛	櫛	櫛	瀛
6660	BIG5	C374	C375	C376	C377	C378	C379	C37A	C37B	C37C	C37D	C37E	C3A1	C3A2	C3A3	C3A4	C3A5
	Char.	瀟	瀨	瀚	瀝	瀕	瀟	爆	爍	牘	犢	獸	獺	璽	瓊	瓣	疇
6670	BIG5	C3A6	C3A7	C3A8	C3A9	C3AA	C3AB	C3AC	C3AD	C3AE	C3AF	C3B0	C3B1	C3B2	C3B3	C3B4	C3B5
	Char.	疆	癩	癡	矇	礙	禱	穫	穩	簾	簿	簸	簽	簞	籊	繫	繭
6680	BIG5		C3B6	C3B7	C3B8	C3B9	C3BA	C3BB	C3BC	C3BD	C3BE	C3BF	C3C0	C3C1	C3C2	C3C3	C3C4
	Char.		繹	繩	繪	羅	繳	羶	羹	羸	臘	藩	藝	藪	藕	藤	藥
6690	BIG5	C3C5	C3C6	C3C7	C3C8	C3C9	C3CA	C3CB	C3CC	C3CD	C3CE	C3CF	C3D0	C3D1	C3D2	C3D3	C3D4
	Char.	譚	蟻	蠅	蠟	蟹	蟾	襠	襟	襖	襪	諱	譜	識	證	譚	譚
66A0	BIG5	C3D5	C3D6	C3D7	C3D8	C3D9	C3DA	C3DB	C3DC	C3DD	C3DE	C3DF	C3E0	C3E1	C3E2	C3E3	C3E4
	Char.	譚	譚	譚	贈	贊	蹠	蹲	蹠	蹠	蹠	蹠	蹠	麟	轆	辭	邊
66B0	BIG5	C3E5	C3E6	C3E7	C3E8	C3E9	C3EA	C3EB	C3EC	C3ED	C3EE	C3EF	C3F0	C3F1	C3F2	C3F3	C3F4
	Char.	邈	醜	醜	鏡	鎬	銑	銑	鏈	鏗	鏗	鏗	鏗	鏗	鏗	鏗	鏗
66C0	BIG5	C3F5	C3F6	C3F7	C3F8	C3F9	C3FA	C3FB	C3FC	C3FD	C3FE	C440	C441	C442	C443	C444	C445
	Char.	鑿	關	隴	難	霽	霧	靡	韜	韻	類	願	顛	颯	饅	饅	鶩
66D0	BIG5	C446	C447	C448	C449	C44A	C44B	C44C	C44D	C44E	C44F	C450	C451	C452	C453	C454	C455
	Char.	騙	鬚	鯨	鯨	鯖	鯛	鶉	鶉	鶉	鶉	鶉	鶉	鶉	麗	麗	麴
66E0	BIG5	C456	C457	C458	C459	C45A	C45B	C45C	C45D	C45E	C45F	C460	C461	C462	C463	C464	C465
	Char.	嚙	嚙	嚙	嚴	嚼	壤	孀	孀	孽	寶	巉	懸	懺	攘	攔	攔
66F0	BIG5	C466	C467	C468	C469	C46A	C46B	C46C	C46D	C46E	C46F	C470	C471	C472	C473		
	Char.	曦	朧	櫛	瀾	瀾	激	爐	獻	瓏	癢	癢	礦	礪	礪		

Table B-3 IBM à Big5 Conversion Table (continued)

IBM		+ 0	+ 1	+ 2	+ 3	+ 4	+ 5	+ 6	+ 7	+ 8	+ 9	+ A	+ B	+ C	+ D	+ E	+ F
6740	BIG5		C474	C475	C476	C477	C478	C479	C47A	C47B	C47C	C47D	C47E	C4A1	C4A2	C4A3	C4A4
	Char.		磔	竇	競	籌	籃	籍	糯	糲	辦	績	繼	纂	罌	耀	臚
6750	BIG5	C4A5	C4A6	C4A7	C4A8	C4A9	C4AA	C4AB	C4AC	C4AD	C4AE	C4AF	C4B0	C4B1	C4B2	C4B3	C4B4
	Char.	艦	藻	藹	磨	藺	蘆	蘋	蘇	蘊	蠟	蠕	襜	覺	觸	識	讐
6760	BIG5	C4B5	C4B6	C4B7	C4B8	C4B9	C4BA	C4BB	C4BC	C4BD	C4BE	C4BF	C4C0	C4C1	C4C2	C4C3	C4C4
	Char.	警	譯	諛	諠	贏	贍	蕙	躁	躅	躑	醴	釋	鐘	鏡	鑄	聞
6770	BIG5	C4C5	C4C6	C4C7	C4C8	C4C9	C4CA	C4CB	C4CC	C4CD	C4CE	C4CF	C4D0	C4D1	C4D2	C4D3	C4D4
	Char.	霰	飄	饒	饑	馨	壽	騰	駮	駟	鯁	鯁	鹹	麵	黨	鼯	齟
6780	BIG5		C4D5	C4D6	C4D7	C4D8	C4D9	C4DA	C4DB	C4DC	C4DD	C4DE	C4DF	C4E0	C4E1	C4E2	C4E3
	Char.		齟	齡	儷	儷	囁	囁	囁	夔	屬	巍	懼	懾	攝	攜	爛
6790	BIG5	C4E4	C4E5	C4E6	C4E7	C4E8	C4E9	C4EA	C4EB	C4EC	C4ED	C4EE	C4EF	C4F0	C4F1	C4F2	C4F3
	Char.	曩	櫻	欄	樞	殲	灌	爛	穢	瓌	瓌	癩	曉	籐	纏	績	屨
67A0	BIG5	C4F4	C4F5	C4F6	C4F7	C4F8	C4F9	C4FA	C4FB	C4FC	C4FD	C4FE	C540	C541	C542	C543	C544
	Char.	蕈	蘭	薜	螭	蠶	蠶	蠶	襪	襪	覽	謎	護	譽	賊	躊	躍
67B0	BIG5	C545	C546	C547	C548	C549	C54A	C54B	C54C	C54D	C54E	C54F	C550	C551	C552	C553	C554
	Char.	躑	轟	辯	醺	鏹	鏹	鐵	錯	鐸	錫	鑄	關	霸	霹	露	響
67C0	BIG5	C555	C556	C557	C558	C559	C55A	C55B	C55C	C55D	C55E	C55F	C560	C561	C562	C563	C564
	Char.	願	顛	饗	驅	驃	驃	驃	骸	魔	魑	魑	鯨	鶯	鶴	鶴	鶉
67D0	BIG5	C565	C566	C567	C568	C569	C56A	C56B	C56C	C56D	C56E	C56F	C570	C571	C572	C573	C574
	Char.	麝	黯	鞏	齟	齟	齟	儼	儼	嚙	囊	囉	攀	巔	巒	彎	懿
67E0	BIG5	C575	C576	C577	C578	C579	C57A	C57B	C57C	C57D	C57E	C5A1	C5A2	C5A3	C5A4	C5A5	C5A6
	Char.	攤	權	歡	灑	灘	獮	瓠	疊	癩	癩	禳	籠	籟	聾	聽	臟
67F0	BIG5	C5A7	C5A8	C5A9	C5AA	C5AB	C5AC	C5AD	C5AE	C5AF	C5B0	C5B1	C5B2	C5B3	C5B4		
	Char.	襲	襯	艘	讀	贖	贖	躑	躑	躑	躑	鑄	鑑	鑒	霽		

Table B-3 IBM à Big5 Conversion Table (continued)

IBM		+ 0	+ 1	+ 2	+ 3	+ 4	+ 5	+ 6	+ 7	+ 8	+ 9	+ A	+ B	+ C	+ D	+ E	+ F
6840	BIG5		C5B5	C5B6	C5B7	C5B8	C5B9	C5BA	C5BB	C5BC	C5BD	C5BE	C5BF	C5C0	C5C1	C5C2	C5C3
	Char.		霏	韃	韃	顛	饗	驕	曉	鱗	鬚	繁	鏈	鏢	鰻	鷓	鷓
6850	BIG5	C5C4	C5C5	C5C6	C5C7	C5C8	C5C9	C5CA	C5CB	C5CC	C5CD	C5CE	C5CF	C5D0	C5D1	C5D2	C5D3
	Char.	颯	齧	齧	龔	嚇	巖	戀	擘	攪	攪	曬	櫃	瓊	竊	籤	簡
6860	BIG5	C5D4	C5D5	C5D6	C5D7	C5D8	C5D9	C5DA	C5DB	C5DC	C5DD	C5DE	C5DF	C5E0	C5E1	C5E2	C5E3
	Char.	籥	纓	織	纒	贖	蕪	蘿	蠱	變	邏	邏	鑣	鑠	鐸	歷	顯
6870	BIG5	C5E4	C5E5	C5E6	C5E7	C5E8	C5E9	C5EA	C5EB	C5EC	C5ED	C5EE	C5EF	C5F0	C5F1	C5F2	C5F3
	Char.	鑿	鷺	驛	驗	髓	體	潤	鱈	鱗	鰓	鷺	麟	徽	囑	壩	攬
6880	BIG5		C5F4	C5F5	C5F6	C5F7	C5F8	C5F9	C5FA	C5FB	C5FC	C5FD	C5FE	C640	C641	C642	C643
	Char.		灑	癩	癩	盪	罐	羈	蠶	蠶	衛	讓	譏	識	艷	鞞	釀
6890	BIG5	C644	C645	C646	C647	C648	C649	C64A	C64B	C64C	C64D	C64E	C64F	C650	C651	C652	C653
	Char.	鑪	靈	靈	霏	韃	鞏	驟	餐	斃	嶺	鷹	鷺	齡	鹽	龍	齧
68A0	BIG5	C654	C655	C656	C657	C658	C659	C65A	C65B	C65C	C65D	C65E	C65F	C660	C661	C662	C663
	Char.	齧	應	攬	灣	籬	籬	蠻	觀	躡	覺	鑲	鎗	顛	饒	骯	蠻
68B0	BIG5	C664	C665	C666	C667	C668	C669	C66A	C66B	C66C	C66D	C66E	C66F	C670	C671	C672	C673
	Char.	鬘	灑	囑	讚	鑄	韃	驢	驢	纒	謙	躡	醜	鑽	鑿	鑠	鍾
68C0	BIG5	C674	C675	C676	C677	C678	C679	C67A	C67B	C67C	C67D	C67E	FFFF	FFFF	FFFF	FFFF	FFFF
	Char.	鑪	贖	豔	鑿	鸚	燻	驢	鬱	鶴	鸞	籟					
68D0	BIG5	FFFF	FFFF	FFFF	FFFF	FFFF	FFFF	FFFF	FFFF	FFFF	FFFF	FFFF	FFFF	FFFF	FFFF	FFFF	FFFF
	Char.																
68E0	BIG5	FFFF	FFFF	FFFF	FFFF	FFFF	FFFF	FFFF	FFFF	FFFF	FFFF	FFFF	FFFF	FFFF	FFFF	FFFF	FFFF
	Char.																

Table B-3 IBM à Big5 Conversion Table (continued)

IBM		+ 0	+ 1	+ 2	+ 3	+ 4	+ 5	+ 6	+ 7	+ 8	+ 9	+ A	+ B	+ C	+ D	+ E	+ F
68F0	BIG5	FFFF	FFFF	FFFF	FFFF	FFFF	FFFF	FFFF	FFFF	FFFF	FFFF	FFFF	FFFF	FFFF	FFFF		
	Char.																
6940	BIG5		C940	C941	C942	C943	C944	C945	C946	C947	C948	C949	C94A	C94B	C94C	C94D	C94E
	Char.		乂	乚	凵	匸	厂	万	丌	乇	予	口	兀	屮	彳	丐	有
6950	BIG5	C94F	C950	C951	C952	C953	C954	C955	C956	C957	C958	C959	C95A	C95B	C95C	C95D	C95E
	Char.	与	乚	亍	仿	仇	伙	尢	旬	印	去	乚	及	夫	彳	市	死
6960	BIG5	C95F	C960	C961	C962	C963	C964	C965	C966	C967	C968	C969	C96A	C96B	C96C	C96D	C96E
	Char.	安	毋	气	彳	屮	井	亍	亍	仕	乞	全	亍	刂	匚	冊	圻
6970	BIG5	C96F	C970	C971	C972	C973	C974	C975	C976	C977	C978	C979	C97A	C97B	C97C	C97D	C97E
	Char.	圣	夂	秀	宁	宥	余	尻	男	亍	疋	疋	庆	刂	戎	劫	气
6980	BIG5		C9A1	C9A2	C9A3	C9A4	C9A5	C9A6	C9A7	C9A8	C9A9	C9AA	C9AB	C9AC	C9AD	C9AE	C9AF
	Char.		承	汎	汎	汎	发	犷	王	内	肥	助	伎	优	伋	件	伋
6990	BIG5	C9B0	C9B1	C9B2	C9B3	C9B4	C9B5	C9B6	C9B7	C9B8	C9B9	C9BA	C9BB	C9BC	C9BD	C9BE	C9BF
	Char.	伶	佢	价	佢	佢	佢	佢	佢	佢	佢	佢	佢	佢	佢	刂	刂
69A0	BIG5	C9C0	C9C1	C9C2	C9C3	C9C4	C9C5	C9C6	C9C7	C9C8	C9C9	C9CA	C9CB	C9CC	C9CD	C9CE	C9CF
	Char.	荔	匚	匚	匚	屮	呼	囟	囟	圪	圪	均	弁	改	姪	虹	姪
69B0	BIG5	C9D0	C9D1	C9D2	C9D3	C9D4	C9D5	C9D6	C9D7	C9D8	C9D9	C9DA	C9DB	C9DC	C9DD	C9DE	C9DF
	Char.	妯	奸	尪	孛	孛	尪	岬	岬	岬	岬	荒	开	庄	异	箝	狗
69C0	BIG5	C9E0	C9E1	C9E2	C9EC	C9E3	C9E4	C9E5	C9E6	C9E7	C9E8	C9E9	C9EA	C9EB	C9ED	C9EE	C9EF
	Char.	伙	乞	仟	托	扌	扌	扌	扌	扌	扌	扌	扌	扌	扌	扌	扌
69D0	BIG5	C9F0	C9F1	C9F2	C9F3	C9F4	C9F5	C9F6	C9F7	C9F8	C9F9	C9FA	C9FB	C9FC	C9FD	C9FE	CA40
	Char.	机	机	机	机	束	机	机	机	氖	余	汜	汜	汜	汜	汜	汜

Table B-3 IBM à Big5 Conversion Table (continued)

IBM		+ 0	+ 1	+ 2	+ 3	+ 4	+ 5	+ 6	+ 7	+ 8	+ 9	+ A	+ B	+ C	+ D	+ E	+ F
69E0	BIG5	CA41	CA42	CA43	CA44	CA45	CA46	CA47	CA48	CA49	CA4A	CA4B	CA4C	CA4D	CA4E	CA4F	CA50
	Char.	刼	勃	犴	犵	玳	甬	虬	竈	网	艸	芋	芳	芫	芴	虍	商
69F0	BIG5	CA51	CA52	CA53	CA54	CA55	CA56	CA57	CA58	CA59	CA5A	CA5B	CA5C	CA5D	CA5E		
	Char.	邨	邨	邨	邨	邨	阢	阢	阢	阢	秘	倅	佺	佺	佺		
6A40	BIG5		CA5F	CA60	CA61	CA62	CA63	CA64	CA65	CA66	CA67	CA68	CA69	CA6A	CA6B	CA6C	CA6D
	Char.		佻	佻	佻	佻	佻	佻	佻	佻	世	佻	佻	佻	佻	佻	佻
6A50	BIG5	CA6E	CA6F	CA70	CA71	CA72	CA73	CA74	CA75	CA76	CA77	CA78	CA79	CA7A	CA7B	CA7C	CA7D
	Char.	剛	劬	劬	劬	劬	劬	底	厓	𠂇	映	吡	𠂇	𠂇	𠂇	𠂇	𠂇
6A60	BIG5	CA7E	CAA1	CAA2	CAA3	CAA4	CAA5	CAA6	CAA7	CAA8	CAA9	CAAA	CAAB	CAAC	CAAD	CAAE	CAAF
	Char.	𠂇	𠂇	𠂇	𠂇	𠂇	𠂇	𠂇	𠂇	𠂇	𠂇	𠂇	𠂇	𠂇	𠂇	𠂇	𠂇
6A70	BIG5	CAB0	CAB1	CAB2	CAB3	CAB4	CAB5	CAB6	CAB7	CAB8	CAB9	CABA	CABB	CABC	CABD	CABE	CABF
	Char.	𠂇	𠂇	𠂇	𠂇	𠂇	𠂇	𠂇	𠂇	𠂇	𠂇	𠂇	𠂇	𠂇	𠂇	𠂇	𠂇
6A80	BIG5		CAC0	CAC1	CAC2	CAC3	CAC4	CAC5	CAC6	CAC7	CAC8	CAC9	CACA	CACB	CACC	CACD	CACE
	Char.		𠂇	𠂇	𠂇	𠂇	𠂇	𠂇	𠂇	𠂇	𠂇	𠂇	𠂇	𠂇	𠂇	𠂇	𠂇
6A90	BIG5	CACF	CAD0	CAD1	CAD2	CAD3	CAD4	CAD5	CAD6	CAD7	CAD8	CAD9	CADA	CADB	CADC	CADD	CADE
	Char.	𠂇	𠂇	𠂇	𠂇	𠂇	𠂇	𠂇	𠂇	𠂇	𠂇	𠂇	𠂇	𠂇	𠂇	𠂇	𠂇
6AA0	BIG5	CADF	CAE0	CAE1	CAE2	CAE3	CAE4	CAE5	CAE6	CAE7	CAE8	CAE9	CAEA	CAEB	CAEC	CAED	CAEE
	Char.	𠂇	𠂇	𠂇	𠂇	𠂇	𠂇	𠂇	𠂇	𠂇	𠂇	𠂇	𠂇	𠂇	𠂇	𠂇	𠂇
6AB0	BIG5	CAEF	CAF0	CAF1	CAF2	CAF3	CAF4	CAF5	CAF6	CAF7	CAF8	CAF9	CAFA	CAFB	CAFC	CAFD	CAFE
	Char.	𠂇	𠂇	𠂇	𠂇	𠂇	𠂇	𠂇	𠂇	𠂇	𠂇	𠂇	𠂇	𠂇	𠂇	𠂇	𠂇
6AC0	BIG5	CB40	CB41	CB42	CB43	CB44	CB45	CB46	CB47	CB48	CB49	CB4A	CB4B	CB4C	CB4D	CB4E	CB4F
	Char.	𠂇	𠂇	𠂇	𠂇	𠂇	𠂇	𠂇	𠂇	𠂇	𠂇	𠂇	𠂇	𠂇	𠂇	𠂇	𠂇
6AD0	BIG5	CB50	CB51	CB52	CB53	CB54	CB55	CB56	CB57	CB58	CB59	CB5A	CB5B	CB5C	CB5D	CB5E	CB5F
	Char.	𠂇	𠂇	𠂇	𠂇	𠂇	𠂇	𠂇	𠂇	𠂇	𠂇	𠂇	𠂇	𠂇	𠂇	𠂇	𠂇

Table B-3 IBM à Big5 Conversion Table (continued)

IBM		+ 0	+ 1	+ 2	+ 3	+ 4	+ 5	+ 6	+ 7	+ 8	+ 9	+ A	+ B	+ C	+ D	+ E	+ F
6AE0	BIG5	CB60	CB61	CB62	CB63	CB64	CB65	CB66	CB67	CB68	CB69	CB6A	CB6B	CB6C	CB6D	CB6E	CB6F
	Char.	物	狝	狝	狝	狝	狝	狝	狝	玨	玨	玨	玨	玨	玨	粵	疔
6AF0	BIG5	CB70	CB71	CB72	CB73	CB74	CB75	CB76	CB77	CB78	CB79	CB7A	CB7B	CB7C	CB7D		
	Char.	疔	阜	祢	聒	肋	肩	肱	肱	彤	苻	苻	苻	苻	苻		
6B40	BIG5		CB7E	CBA1	CBA2	CBA3	CBA4	CBA5	CBA6	CBA7	CBA8	CBA9	CBAA	CBAB	CBAC	CBAD	CBAE
	Char.		芋	芋	芑	芑	豸	迨	迨	邗	邗	邗	邗	邗	邗	阝	阝
6B50	BIG5	CBAF	CBB0	CBB1	CBB2	CBB3	CBB4	CBB5	CBB6	CBB7	CBB8	CBB9	CBBA	CBBB	CBBC	CBBD	CBBE
	Char.	阝	阝	弗	侏	侏	侏	侏	侏	侏	侏	侏	侏	侏	侏	侏	侏
6B60	BIG5	CBBF	CBC0	CBC1	CBC2	CBC3	CBC4	CBC5	CBC6	CBC7	CBC8	CBC9	CBCA	CBCB	CBCC	CBCD	CBCE
	Char.	侏	侏	侏	侏	侏	侏	侏	侏	侏	侏	侏	侏	侏	侏	侏	侏
6B70	BIG5	CBCF	CBD0	CBD1	CBD2	CBD3	CBD4	CBD5	CBD6	CBD7	CBD8	CBD9	CBDA	CBDB	CBDC	CBDD	CBDE
	Char.	洽	刳	刳	刳	刳	刳	刳	刳	匚	匚	匚	匚	匚	叕	咁	咁
6B80	BIG5		CBDF	CBE0	CBE1	CBE2	CBE3	CBE4	CBE5	CBE6	CBE7	CBE8	CBE9	CBEA	CBEB	CBEC	CBED
	Char.		啞	佛	咁	咁	咁	咁	咁	咁	咁	咁	咁	咁	咁	咁	咁
6B90	BIG5	CBEE	CBEF	CBF0	CBF1	CBF2	CBF3	CBF4	CBF5	CBF6	CBF7	CBF8	CBF9	CBFA	CBFB	CBFC	CBFD
	Char.	咁	咁	困	困	坏	拂	坭	站	块	坳	埠	坪	坵	坵	坵	壘
6BA0	BIG5	CBFE	CC40	CC41	CC42	CC43	CC44	CC45	CC46	CC47	CC48	CC49	CC4A	CC4B	CC4C	CC4D	CC4E
	Char.	埤	坨	玲	菱	奘	姪	姪	姪	姪	姪	姪	姪	姪	姪	姪	姪
6BB0	BIG5	CC4F	CC50	CC51	CC52	CC53	CC54	CC55	CC56	CC57	CC58	CC59	CC5A	CC5B	CC5C	CC5D	CC5E
	Char.	姪	姪	姪	姪	姪	姪	姪	姪	姪	姪	姪	姪	姪	姪	姪	姪
6BC0	BIG5	CC5F	CC60	CC61	CC62	CC63	CC64	CC65	CC66	CC67	CC68	CC69	CC6A	CC6B	CC6C	CC6D	CC6E
	Char.	岈	岈	岈	岈	岈	岈	岈	岈	岈	岈	岈	岈	岈	岈	岈	岈

Table B-3 IBM à Big5 Conversion Table (continued)

IBM		+ 0	+ 1	+ 2	+ 3	+ 4	+ 5	+ 6	+ 7	+ 8	+ 9	+ A	+ B	+ C	+ D	+ E	+ F
6BD0	BIG5	CC6F	CC70	CC71	CC72	CC73	CC74	CC75	CC76	CC77	CC78	CC79	CC7A	CC7B	CC7C	CC7D	CC7E
	Char.	帙	韶	攷	粥	砥	泉	徂	徐	低	恣	氦	悒	悻	怙	柄	恨
6BE0	BIG5	CCA1	CCA2	CCA3	CCA4	CCA5	CCA6	CCA7	CCA8	CCA9	CCAA	CCAB	CCAC	CCAD	CCAE	CCAF	CCB0
	Char.	悫	悫	怙	悫	悫	悫	悫	悫	悫	悫	悫	悫	悫	悫	悫	悫
6BF0	BIG5	CCB1	CCB2	CCB3	CCB4	CCB5	CCB6	CCB7	CCB8	CCB9	CCBA	CCBB	CCBC	CCBD	CCBE		
	Char.	菱	屮	抗	摠	拊	拊	拊	拊	拊	拊	拊	拊	拊	拊		
6C40	BIG5		CCBF	CCC0	CCC1	CCC2	CCC3	CCC4	CCC5	CCC6	CCC7	CCC8	CCC9	CCCA	CCCB	CCCC	CCCD
	Char.		挾	擗	斂	斂	斂	斂	斂	斂	斂	斂	斂	斂	斂	斂	斂
6C50	BIG5	CCCE	CCCF	CCD0	CCD1	CCD2	CCD3	CCD4	CCD5	CCD6	CCD7	CCD8	CCD9	CCDA	CCDB	CCDC	CCDD
	Char.	吨	吟	盼	習	阮	枅	枅	枅	枅	枅	枅	枅	枅	枅	枅	枅
6C60	BIG5	CCDE	CCDF	CCE0	CCE1	CCE2	CCE3	CCE4	CCE5	CCE6	CCE7	CCE8	CCE9	CCEA	CCEB	CCEC	CCED
	Char.	粉	枳	枳	枳	枳	枳	枳	枳	枳	枳	枳	枳	枳	枳	枳	枳
6C70	BIG5	CCEE	CCFE	CCF0	CCF1	CCF2	CCF3	CCF4	CCF5	CCF6	CCF7	CCF8	CCF9	CCFA	CCFB	CCFC	CCFD
	Char.	沓	沓	沓	沓	沓	沓	沓	沓	沓	沓	沓	沓	沓	沓	沓	沓
6C80	BIG5		CCFE	CD40	CD41	CD42	CD43	CD44	CD45	CD46	CD47	CD48	CD49	CD4A	CD4B	CD4C	CD4D
	Char.		涕	涸	涸	涸	涸	涸	涸	涸	涸	涸	涸	涸	涸	涸	涸
6C90	BIG5	CD4E	CD4F	CD50	CD51	CD52	CD53	CD54	CD55	CD56	CD57	CD58	CD59	CD5A	CD5B	CD5C	CD5D
	Char.	洸	洸	洸	洸	洸	洸	洸	洸	洸	洸	洸	洸	洸	洸	洸	洸
6CA0	BIG5	CD5E	CD5F	CD60	CD61	CD62	CD63	CD64	CD65	CD66	CD67	CD68	CD69	CD6A	CD6B	CD6C	CD6D
	Char.	狻	狻	狻	狻	狻	狻	狻	狻	狻	狻	狻	狻	狻	狻	狻	狻
6CB0	BIG5	CD6E	CD6F	CD70	CD71	CD72	CD73	CD74	CD75	CD76	CD77	CD78	CD79	CD7A	CD7B	CD7C	CD7D
	Char.	廔	廔	廔	廔	廔	廔	廔	廔	廔	廔	廔	廔	廔	廔	廔	廔

Table B-3 IBM à Big5 Conversion Table (continued)

IBM		+ 0	+ 1	+ 2	+ 3	+ 4	+ 5	+ 6	+ 7	+ 8	+ 9	+ A	+ B	+ C	+ D	+ E	+ F
6CC0	BIG5	CD7E	CDA1	CDA2	CDA3	CDA4	CDA5	CDA6	CDA7	CDA8	CDA9	CDAA	CDAB	CDAC	CDAD	CDAE	CDAF
	Char.	砵	砷	衤	衲	秝	粍	穿	笏	料	紉	訂	禽	肮	矜	肸	斲
6CD0	BIG5	CDB0	CDB1	CDB2	CDB3	CDB4	CDB5	CDB6	CDB7	CDB8	CDB9	CDBA	CDBB	CDBC	CDBD	CDBE	CDBF
	Char.	衲	衲	苳	荒	茺	菴	茈	茅	茭	茅	茭	茭	茭	茭	茭	茭
6CE0	BIG5	CDC0	CDC1	CDC2	CDC3	CDC4	CDC5	CDC6	CDC7	CDC8	CDC9	CDCA	CDCB	CDCC	CDCD	CDCE	CDCF
	Char.	茭	茭	茭	茭	茭	茭	茭	茭	茭	茭	茭	豕	迳	迳	迳	迳
6CF0	BIG5	CDD0	CDD1	CDD2	CDD3	CDD4	CDD5	CDD6	CDD7	CDD8	CDD9	CDDA	Cddb	CDDC	CDDD		
	Char.	迳	迳	迳	邲	邲	邲	邲	邲	陸	陆	阝	阝	阝	阝		
6D40	BIG5		CDDE	CDDF	CDE0	CDE1	CDE2	CDE3	CDE4	CDE5	CDE6	CDE7	CDE8	CDE9	CDEA	CDEB	CDEC
	Char.		倝	倝	倝	倝	倝	倝	倝	倝	倝	倝	倝	倝	倝	倝	倝
6D50	BIG5	CDED	CDEE	CDEF	CDF0	CDF1	CDF2	CDF3	CDF4	CDF5	CDF6	CDF7	CDF8	CDF9	CDFA	CDFB	CDFC
	Char.	倝	倝	倝	劉	劉	勅	勅	匱	脆	厩	厩	厩	厩	厩	厩	厩
6D60	BIG5	CDFD	CDFE	CE40	CE41	CE42	CE43	CE44	CE45	CE46	CE47	CE48	CE49	CE4A	CE4B	CE4C	CE4D
	Char.	啞	啞	啞	啞	啞	啞	啞	啞	啞	啞	聿	聿	聿	聿	聿	聿
6D70	BIG5	CE4E	CE4F	CE50	CE51	CE52	CE53	CE54	CE55	CE56	CE57	CE58	CE59	CE5A	CE5B	CE5C	CE5D
	Char.	啞	啞	垠	垠	垠	垠	垠	垠	垠	垠	壘	壘	壘	壘	壘	壘
6D80	BIG5		CE5E	CE5F	CE60	CE61	CE62	CE63	CE64	CE65	CE66	CE67	CE68	CE69	CE6A	CE6B	CE6C
	Char.		厘	厘	复	參	姪	姪	姪	城	婿	姪	姪	姪	姪	姪	姪
6D90	BIG5	CE6D	CE6E	CE6F	CE70	CE71	CE72	CE73	CE74	CE75	CE76	CE77	CE78	CE79	CE7A	CE7B	CE7C
	Char.	姪	姪	姪	姪	姪	姪	姪	姪	裂	姪	窕	屮	咳	峒	峒	峒
6DA0	BIG5	CE7D	CE7E	CEA1	CEA2	CEA3	CEA4	CEA5	CEA6	CEA7	CEA8	CEA9	CEAA	CEAB	CEAC	CEAD	CEAE
	Char.	峒	峒	峒	峒	峒	峒	崑	峒	峒	峒	峒	峒	峒	峒	峒	峒

Table B-3 IBM à Big5 Conversion Table (continued)

IBM		+ 0	+ 1	+ 2	+ 3	+ 4	+ 5	+ 6	+ 7	+ 8	+ 9	+ A	+ B	+ C	+ D	+ E	+ F
6DB0	BIG5	CEAF	CEB0	CEB1	CEB2	CEB3	CEB4	CEB5	CEB6	CEB7	CEB8	CEB9	CEBA	CEBB	CEBC	CEBD	CEBE
	Char.	馨	蚌	蛤	希	帛	帑	屏	序	塵	庇	庀	麻	奔	眷	象	循
6DC0	BIG5	CEBF	CEC0	CEC1	CEC2	CEC3	CEC4	CEC5	CEC6	CEC7	CEC8	CEC9	CECA	CECB	CECC	CECD	CECE
	Char.	恋	愆	校	併	悵	恠	恡	恣	恵	恶	恷	恸	恹	恻	恻	恻
6DD0	BIG5	CECF	CED0	CED1	CED2	CED3	CED4	CED5	CED6	CED7	CED8	CED9	CEDA	CEDB	CEDC	CEDD	CEDE
	Char.	恸	恹	恻	恻	恻	拏	拑	拒	拓	拔	拕	拖	拗	拘	拙	拚
6DE0	BIG5	CEDF	CEE0	CEE1	CEE2	CEE3	CEE4	CEE5	CEE6	CEE7	CEE8	CEE9	CEEA	CEEB	CEEC	CEED	CEEE
	Char.	撈	撈	撈	撈	撈	撈	撈	撈	撈	撈	撈	撈	撈	撈	撈	撈
6DF0	BIG5	CEEF	CEF0	CEF1	CEF2	CEF3	CEF4	CEF5	CEF6	CEF7	CEF8	CEF9	CEFA	CEFB	CEFC		
	Char.	易	昇	咄	跌	昫	昫	昫	昫	咏	昫	昫	胸	柁	秘		
6E40	BIG5		CEFD	CEFE	CF40	CF41	CF42	CF43	CF44	CF45	CF46	CF47	CF48	CF49	CF4A	CF4B	CF4C
	Char.		柁	柁	柁	柁	柁	柁	柁	柁	柁	柁	柁	柁	柁	柁	柁
6E50	BIG5	CF4D	CF4E	CF4F	CF50	CF51	CF52	CF53	CF54	CF55	CF56	CF57	CF58	CF59	CF5A	CF5B	CF5C
	Char.	祝	栖	柚	秩	施	袍	柁	柁	柁	柁	柁	柁	柁	柁	柁	柁
6E60	BIG5	CF5D	CF5E	CF5F	CF60	CF61	CF62	CF63	CF64	CF65	CF66	CF67	CF68	CF69	CF6A	CF6B	CF6C
	Char.	柁	柁	柁	柁	柁	柁	柁	柁	柁	柁	柁	柁	柁	柁	柁	柁
6E70	BIG5	CF6D	CF6E	CF6F	CF70	CF71	CF72	CF73	CF74	CF75	CF76	CF77	CF78	CF79	CF7A	CF7B	CF7C
	Char.	淩	泐	泐	泐	泐	泐	泐	泐	泐	泐	泐	泐	泐	泐	泐	泐
6E80	BIG5		CF7D	CF7E	CFA1	CFA2	CFA3	CFA4	CFA5	CFA6	CFA7	CFA8	CFA9	CFAA	CFAB	CFAC	CFAD
	Char.		淩	泐	泐	泐	泐	泐	泐	泐	泐	泐	泐	泐	泐	泐	泐
6E90	BIG5	CFAE	CFAF	CFB0	CFB1	CFB2	CFB3	CFB4	CFB5	CFB6	CFB7	CFB8	CFB9	CFBA	CFBB	CFBC	CFBD
	Char.	炷	烜	烜	烜	烜	烜	烜	烜	烜	烜	烜	烜	烜	烜	烜	烜

Table B-3 IBM à Big5 Conversion Table (continued)

IBM		+ 0	+ 1	+ 2	+ 3	+ 4	+ 5	+ 6	+ 7	+ 8	+ 9	+ A	+ B	+ C	+ D	+ E	+ F
6EA0	BIG5	CFBE	CFBF	CFC0	CFC1	CFC2	CFC3	CFC4	CFC5	CFC6	CFC7	CFC8	CFC9	CFCA	CFCB	CFCC	CFCD
	Char.	臭	狯	狻	狼	狽	狾	狿	獠	獡	玃	珂	珈	琿	琺	琻	琼
6EB0	BIG5	CFCE	CFCF	CFD0	CFD1	CFD2	CFD3	CFD4	CFD5	CFD6	CFD7	CFD8	CFD9	CFDA	CFDB	CFDC	CFDD
	Char.	璠	璡	璢	璣	璤	璥	璦	璧	璨	璩	璪	璫	璬	璭	璮	璯
6EC0	BIG5	CFDE	CFDF	CFE0	CFE1	CFE2	CFE3	CFE4	CFE5	CFE6	CFE7	CFE8	CFE9	CFEA	CFEB	CFEC	CFED
	Char.	璹	璺	璽	璾	璿	璻	璼	璽	璿	璿	璿	璿	璿	璿	璿	璿
6ED0	BIG5	CFEE	CFEF	CFF0	CFF1	CFF2	CFF3	CFF4	CFF5	CFF6	CFF7	CFF8	CFF9	CFFA	CFFB	CFFC	CFFD
	Char.	硁	硂	硃	硄	硅	硆	硇	硈	硉	硊	硋	硌	硍	硎	硏	硓
6EE0	BIG5	CFFE	D040	D041	D042	D043	D044	D045	D046	D047	D048	D049	D04A	D04B	D04C	D04D	D04E
	Char.	窰	窠	窣	窵	窶	窷	窸	窹	窺	窻	窼	窽	窾	窿	窼	窽
6EF0	BIG5	D04F	D050	D051	D052	D053	D054	D055	D056	D057	D058	D059	D05A	D05B	D05C		
	Char.	窾	窿	窼	窽	窿	窽	窿	窽	窿	窽	窿	窽	窿	窽		
6F40	BIG5		D05D	D05E	D05F	D060	D061	D062	D063	D064	D065	D066	D067	D068	D069	D06A	D06B
	Char.		肤	脍	胙	胛	胜	胝	胞	胟	胠	胡	胢	胣	胤	胥	胙
6F50	BIG5	D06C	D06D	D06E	D06F	D070	D071	D072	D073	D074	D075	D076	D077	D078	D079	D07A	D07B
	Char.	苾	萃	苾	苿	苻	苿	苿	苿	苿	苿	苿	苿	苿	苿	苿	苿
6F60	BIG5	D07C	D07D	D07E	D0A1	D0A2	D0A3	D0A4	D0A5	D0A6	D0A7	D0A8	D0A9	D0AA	D0AB	D0AC	D0AD
	Char.	茶	菘	菡	菢	菣	菤	菥	菦	菧	菨	菩	菮	華	菰	菰	菰
6F70	BIG5	D0AE	D0AF	D0B0	D0B1	D0B2	D0B3	D0B4	D0B5	D0B6	D0B7	D0B8	D0B9	D0BA	D0BB	D0BC	D0BD
	Char.	萩	觥	觥	觥	觥	觥	觥	觥	觥	觥	觥	觥	觥	觥	觥	觥
6F80	BIG5		DOBE	D0BF	DOC0	DOC1	DOC2	DOC3	DOC4	DOC5	DOC6	DOC7	DOC8	DOC9	DOCA	DOCB	DOCC
	Char.		郇	郈	郇	郇	郇	郇	郇	郇	郇	郇	郇	郇	郇	郇	郇

Table B-3 IBM à Big5 Conversion Table (continued)

IBM		+ 0	+ 1	+ 2	+ 3	+ 4	+ 5	+ 6	+ 7	+ 8	+ 9	+ A	+ B	+ C	+ D	+ E	+ F
6F90	BIG5	D0CD	D0CE	D0CF	D0D0	D0D1	D0D2	D0D3	D0D4	D0D5	D0D6	D0D7	D0D8	D0D9	D0DA	D0DB	D0DC
	Char.	儂	俱	儀	儂	傳	倅	倅	倅	倅	倅	倅	倅	倅	倅	倅	倅
6FA0	BIG5	D0DD	D0DE	D0DF	D0E0	D0E1	D0E2	D0E3	D0E4	D0E5	D0E6	D0E7	D0E8	D0E9	D0EA	D0EB	D0EC
	Char.	儂	党	尋	菁	清	淒	涸	淨	淦	剡	剡	剡	剡	剡	剡	剡
6FB0	BIG5	D0ED	D0EE	D0EF	D0F0	D0F1	D0F2	D0F3	D0F4	D0F5	D0F6	D0F7	D0F8	D0F9	D0FA	D0FB	D0FC
	Char.	勅	蜀	腓	吵	瞬	哇	晒	哧	晰	嘍	嘍	嘍	嘍	嘍	嘍	嘍
6FC0	BIG5	D0FD	D0FE	D140	D141	D142	D143	D144	D145	D146	D147	D148	D149	D14A	D14B	D14C	D14D
	Char.	哈	哼	映	啤	呼	唛	皓	喇	响	唢	囡	囡	垠	聖	埕	埕
6FD0	BIG5	D14E	D14F	D150	D151	D152	D153	D154	D155	D156	D157	D158	D159	D15A	D15B	D15C	D15D
	Char.	埕	埕	埕	埕	埕	埕	埕	埕	埕	埕	埕	埕	埕	埕	埕	埕
6FE0	BIG5	D15E	D15F	D160	D161	D162	D163	D164	D165	D166	D167	D168	D169	D16A	D16B	D16C	D16D
	Char.	娉	娉	娉	娉	娉	娉	娉	娉	娉	娉	娉	娉	娉	娉	娉	娉
6FF0	BIG5	D16E	D16F	D170	D171	D172	D173	D174	D175	D176	D177	D178	D179	D17A	D17B		
	Char.	嶧	嶧	嶧	嶧	嶧	嶧	嶧	嶧	嶧	嶧	嶧	嶧	嶧	嶧		
7040	BIG5		D17C	D17D	D17E	D1A1	D1A2	D1A3	D1A4	D1A5	D1A6	D1A7	D1A8	D1A9	D1AA	D1AB	D1AC
	Char.		愬	愬	愬	愬	愬	愬	愬	愬	愬	愬	愬	愬	愬	愬	愬
7050	BIG5	D1AD	D1AE	D1AF	D1B0	D1B1	D1B2	D1B3	D1B4	D1B5	D1B6	D1B7	D1B8	D1B9	D1BA	D1BB	D1BC
	Char.	愬	愬	愬	愬	愬	愬	愬	愬	愬	愬	愬	愬	愬	愬	愬	愬
7060	BIG5	D1BD	D1BE	D1BF	D1C0	D1C1	D1C2	D1C3	D1C4	D1C5	D1C6	D1C7	D1C8	D1C9	D1CA	D1CB	D1CC
	Char.	揆	揆	揆	揆	揆	揆	揆	揆	揆	揆	揆	揆	揆	揆	揆	揆
7070	BIG5	D1CD	D1CE	D1CF	D1D0	D1D1	D1D2	D1D3	D1D4	D1D5	D1D6	D1D7	D1D8	D1D9	D1DA	D1DB	D1DC
	Char.	欸	欸	欸	欸	欸	欸	欸	欸	欸	欸	欸	欸	欸	欸	欸	欸

Table B-3 IBM à Big5 Conversion Table (continued)

IBM		+ 0	+ 1	+ 2	+ 3	+ 4	+ 5	+ 6	+ 7	+ 8	+ 9	+ A	+ B	+ C	+ D	+ E	+ F
7080	BIG5		D1DD	D1DE	D1DF	D1E0	D1E1	D1E2	D1E3	D1E4	D1E5	D1E6	D1E7	D1E8	D1E9	D1EA	D1EB
	Char.		栲	栲	栲	栲	栲	栲	栲	栲	栲	栲	栲	栲	栲	栲	栲
7090	BIG5	D1EC	D1ED	D1EE	D1EF	D1F0	D1F1	D1F2	D1F3	D1F4	D1F5	D1F6	D1F7	D1F8	D1F9	D1FA	D1FB
	Char.	栲	栲	栲	栲	栲	栲	栲	栲	栲	栲	栲	栲	栲	栲	栲	栲
70A0	BIG5	D1FC	D1FD	D1FE	D240	D241	D242	D243	D244	D245	D246	D247	D248	D249	D24A	D24B	D24C
	Char.	殍	殍	殍	殍	殍	殍	殍	殍	殍	殍	殍	殍	殍	殍	殍	殍
70B0	BIG5	D24D	D24E	D24F	D250	D251	D252	D253	D254	D255	D256	D257	D258	D259	D25A	D25B	D25C
	Char.	殍	殍	殍	殍	殍	殍	殍	殍	殍	殍	殍	殍	殍	殍	殍	殍
70C0	BIG5	D25D	D25E	D25F	D260	D261	D262	D263	D264	D265	D266	D267	D268	D269	D26A	D26B	D26C
	Char.	殍	殍	殍	殍	殍	殍	殍	殍	殍	殍	殍	殍	殍	殍	殍	殍
70D0	BIG5	D26D	D26E	D26F	D270	D271	D272	D273	D274	D275	D276	D277	D278	D279	D27A	D27B	D27C
	Char.	殍	殍	殍	殍	殍	殍	殍	殍	殍	殍	殍	殍	殍	殍	殍	殍
70E0	BIG5	D27D	D27E	D2A1	D2A2	D2A3	D2A4	D2A5	D2A6	D2A7	D2A8	D2A9	D2AA	D2AB	D2AC	D2AD	D2AE
	Char.	殍	殍	殍	殍	殍	殍	殍	殍	殍	殍	殍	殍	殍	殍	殍	殍
70F0	BIG5	D2AF	D2B0	D2B1	D2B2	D2B3	D2B4	D2B5	D2B6	D2B7	D2B8	D2B9	D2BA	D2BB	D2BC		
	Char.	殍	殍	殍	殍	殍	殍	殍	殍	殍	殍	殍	殍	殍	殍		
7140	BIG5		D2BD	D2BE	D2BF	D2C0	D2C1	D2C2	D2C3	D2C4	D2C5	D2C6	D2C7	D2C8	D2C9	D2CA	D2CB
	Char.		殍	殍	殍	殍	殍	殍	殍	殍	殍	殍	殍	殍	殍	殍	殍
7150	BIG5	D2CC	D2CD	D2CE	D2CF	D2D0	D2D1	D2D2	D2D3	D2D4	D2D5	D2D6	D2D7	D2D8	D2D9	D2DA	D2DB
	Char.	殍	殍	殍	殍	殍	殍	殍	殍	殍	殍	殍	殍	殍	殍	殍	殍
7160	BIG5	D2DC	D2DD	D2DE	D2DF	D2E0	D2E1	D2E2	D2E3	D2E4	D2E5	D2E6	D2E7	D2E8	D2E9	D2EA	D2EB
	Char.	殍	殍	殍	殍	殍	殍	殍	殍	殍	殍	殍	殍	殍	殍	殍	殍

Table B-3 IBM à Big5 Conversion Table (continued)

IBM		+ 0	+ 1	+ 2	+ 3	+ 4	+ 5	+ 6	+ 7	+ 8	+ 9	+ A	+ B	+ C	+ D	+ E	+ F
7170	BIG5	D2EC	D2ED	D2EE	D2EF	D2F0	D2F1	D2F2	D2F3	D2F4	D2F5	D2F6	D2F7	D2F8	D2F9	D2FA	D2FB
	Char.	秩	秣	秬	秣	秬	秣	秬	秣	秬	秣	秬	秣	秬	秣	秬	秣
7180	BIG5		D2FC	D2FD	D2FE	D340	D341	D342	D343	D344	D345	D346	D347	D348	D349	D34A	D34B
	Char.		窳	詢	筮	筮	筮	筮	筮	筮	筮	筮	筮	筮	筮	筮	筮
7190	BIG5	D34C	D34D	D34E	D34F	D350	D351	D352	D353	D354	D355	D356	D357	D358	D359	D35A	D35B
	Char.	紉	紉	紉	紉	紉	紉	紉	紉	紉	紉	紉	紉	紉	紉	紉	紉
71A0	BIG5	D35C	D35D	D35E	D35F	D360	D361	D362	D363	D364	D365	D366	D367	D368	D369	D36A	D36B
	Char.	罍	罍	罍	罍	罍	罍	罍	罍	罍	罍	罍	罍	罍	罍	罍	罍
71B0	BIG5	D36C	D36D	D36E	D36F	D370	D371	D372	D373	D374	D375	D376	D377	D378	D379	D37A	D37B
	Char.	脛	脛	脛	脛	脛	脛	脛	脛	脛	脛	脛	脛	脛	脛	脛	脛
71C0	BIG5	D37C	D37D	D37E	D3A1	D3A2	D3A3	D3A4	D3A5	D3A6	D3A7	D3A8	D3A9	D3AA	D3AB	D3AC	D3AD
	Char.	蕘	蕘	蕘	蕘	蕘	蕘	蕘	蕘	蕘	蕘	蕘	蕘	蕘	蕘	蕘	蕘
71D0	BIG5	D3AE	D3AF	D3B0	D3B1	D3B2	D3B3	D3B4	D3B5	D3B6	D3B7	D3B8	D3B9	D3BA	D3BB	D3BC	D3BD
	Char.	苻	苻	苻	苻	苻	苻	苻	苻	苻	苻	苻	苻	苻	苻	苻	苻
71E0	BIG5	D3BE	D3BF	D3C0	D3C1	D3C2	D3C3	D3C4	D3C5	D3C6	D3C7	D3C8	D3C9	D3CA	D3CB	D3CC	D3CD
	Char.	蚪	蚪	蚪	蚪	蚪	蚪	蚪	蚪	蚪	蚪	蚪	蚪	蚪	蚪	蚪	蚪
71F0	BIG5	D3CE	D3CF	D3D0	D3D1	D3D2	D3D3	D3D4	D3D5	D3D6	D3D7	D3D8	D3D9	D3DA	D3DB		
	Char.	蚘	蚘	蚘	蚘	蚘	蚘	蚘	蚘	蚘	蚘	蚘	蚘	蚘	蚘		
7240	BIG5		D3DC	D3DD	D3DE	D3DF	D3E0	D3E1	D3E2	D3E3	D3E4	D3E5	D3E6	D3E7	D3E8	D3E9	D3EA
	Char.		袂	袂	袂	袂	袂	袂	袂	袂	袂	袂	袂	袂	袂	袂	袂
7250	BIG5	D3EB	D3EC	D3ED	D3EE	D3EF	D3F0	D3F1	D3F2	D3F3	D3F4	D3F5	D3F6	D3F7	D3F8	D3F9	D3FA
	Char.	迥	迥	迥	迥	迥	迥	迥	迥	迥	迥	迥	迥	迥	迥	迥	迥

Table B-3 IBM à Big5 Conversion Table (continued)

IBM		+ 0	+ 1	+ 2	+ 3	+ 4	+ 5	+ 6	+ 7	+ 8	+ 9	+ A	+ B	+ C	+ D	+ E	+ F
7260	BIG5	D3FB	D3FC	D3FD	D3FE	D440	D441	D442	D443	D444	D445	D446	D447	D448	D449	D44A	D44B
	Char.	郗	郟	郠	酃	酄	酅	酆	釭	釮	釯	陟	隄	隄	隄	隄	隄
7270	BIG5	D44C	D44D	D44E	D44F	D450	D451	D452	D453	D454	D455	D456	D457	D458	D459	D45A	D45B
	Char.	偁	偂	偃	偄	偅	偆	假	偈	偉	偊	偋	偌	偍	偆	假	偈
7280	BIG5		D45C	D45D	D45E	D45F	D460	D461	D462	D463	D464	D465	D466	D467	D468	D469	D46A
	Char.		僇	僈	僉	僊	僋	僌	働	僎	像	僐	僑	僒	僓	僔	僕
7290	BIG5	D46B	D46C	D46D	D46E	D46F	D470	D471	D472	D473	D474	D475	D476	D477	D478	D479	D47A
	Char.	劓	劔	劒	劓	劔	劒	劓	劔	劒	劓	劔	劒	劓	劔	劒	劓
72A0	BIG5	D47B	D47C	D47D	D47E	D4A1	D4A2	D4A3	D4A4	D4A5	D4A6	D4A7	D4A8	D4A9	D4AA	D4AB	D4AC
	Char.	唵	唎	唍	唎	唎	唎	唎	唎	唎	唎	唎	唎	唎	唎	唎	唎
72B0	BIG5	D4AD	D4AE	D4AF	D4B0	D4B1	D4B2	D4B3	D4B4	D4B5	D4B6	D4B7	D4B8	D4B9	D4BA	D4BB	D4BC
	Char.	埤	埤	埤	埤	埤	埤	埤	埤	埤	埤	埤	埤	埤	埤	埤	埤
72C0	BIG5	D4BD	D4BE	D4BF	D4C0	D4C1	D4C2	D4C3	D4C4	D4C5	D4C6	D4C7	D4C8	D4C9	D4CA	D4CB	D4CC
	Char.	埤	埤	埤	埤	埤	埤	埤	埤	埤	埤	埤	埤	埤	埤	埤	埤
72D0	BIG5	D4CD	D4CE	D4CF	D4D0	D4D1	D4D2	D4D3	D4D4	D4D5	D4D6	D4D7	D4D8	D4D9	D4DA	D4DB	D4DC
	Char.	婁	婁	婁	婁	婁	婁	婁	婁	婁	婁	婁	婁	婁	婁	婁	婁
72E0	BIG5	D4DD	D4DE	D4DF	D4E0	D4E1	D4E2	D4E3	D4E4	D4E5	D4E6	D4E7	D4E8	D4E9	D4EA	D4EB	D4EC
	Char.	婁	婁	婁	婁	婁	婁	婁	婁	婁	婁	婁	婁	婁	婁	婁	婁
72F0	BIG5	D4ED	D4EE	D4EF	D4F0	D4F1	D4F2	D4F3	D4F4	D4F5	D4F6	D4F7	D4F8	D4F9	D4FA		
	Char.	綿	娶	孺	孫	憲	窠	扇	嶠	嶠	嶠	嶠	嶠	嶠	嶠		
7340	BIG5		D4FB	D4FC	D4FD	D4FE	D540	D541	D542	D543	D544	D545	D546	D547	D548	D549	D54A
	Char.		嶠	嶠	嶠	嶠	嶠	嶠	嶠	嶠	嶠	嶠	嶠	嶠	嶠	嶠	嶠
7350	BIG5	D54B	D54C	D54D	D54E	D54F	D550	D551	D552	D553	D554	D555	D556	D557	D558	D559	D55A
	Char.	庫	涼	彌	荷	徐	徇	慙	慙	慙	慙	慙	慙	慙	慙	慙	慙

Table B-3 IBM à Big5 Conversion Table (continued)

IBM		+ 0	+ 1	+ 2	+ 3	+ 4	+ 5	+ 6	+ 7	+ 8	+ 9	+ A	+ B	+ C	+ D	+ E	+ F
7360	BIG5	D55B	D55C	D55D	D55E	D55F	D560	D561	D562	D563	D564	D565	D566	D567	D568	D569	D56A
	Char.	憊	愉	慄	悱	惜	悵	悵	悵	悵	悵	悵	悵	悵	悵	悵	悵
7370	BIG5	D56B	D56C	D56D	D56E	D56F	D570	D571	D572	D573	D574	D575	D576	D577	D578	D579	D57A
	Char.	撻	撻	撻	撻	撻	撻	撻	撻	撻	撻	撻	撻	撻	撻	撻	撻
7380	BIG5		D57B	D57C	D57D	D57E	D5A1	D5A2	D5A3	D5A4	D5A5	D5A6	D5A7	D5A8	D5A9	D5AA	D5AB
	Char.		撻	撻	撻	撻	撻	撻	撻	撻	撻	撻	撻	撻	撻	撻	撻
7390	BIG5	D5AC	D5AD	D5AE	D5AF	D5B0	D5B1	D5B2	D5B3	D5B4	D5B5	D5B6	D5B7	D5B8	D5B9	D5BA	D5BB
	Char.	駿	羸	暫	駘	駘	駘	駘	駘	駘	駘	駘	駘	駘	駘	駘	駘
73A0	BIG5	D5BC	D5BD	D5BE	D5BF	D5C0	D5C1	D5C2	D5C3	D5C4	D5C5	D5C6	D5C7	D5C8	D5C9	D5CA	D5CB
	Char.	裡	裡	裡	裡	裡	裡	裡	裡	裡	裡	裡	裡	裡	裡	裡	裡
73B0	BIG5	D5CC	D5CD	D5CE	D5CF	D5D0	D5D1	D5D2	D5D3	D5D4	D5D5	D5D6	D5D7	D5D8	D5D9	D5DA	D5DB
	Char.	梘	梘	梘	梘	梘	梘	梘	梘	梘	梘	梘	梘	梘	梘	梘	梘
73C0	BIG5	D5DC	D5DD	D5DE	D5DF	D5E0	D5E1	D5E2	D5E3	D5E4	D5E5	D5E6	D5E7	D5E8	D5E9	D5EA	D5EB
	Char.	殍	殍	殍	殍	殍	殍	殍	殍	殍	殍	殍	殍	殍	殍	殍	殍
73D0	BIG5	D5EC	D5ED	D5EE	D5EF	D5F0	D5F1	D5F2	D5F3	D5F4	D5F5	D5F6	D5F7	D5F8	D5F9	D5FA	D5FB
	Char.	澀	澀	澀	澀	澀	澀	澀	澀	澀	澀	澀	澀	澀	澀	澀	澀
73E0	BIG5	D5FC	D5FD	D5FE	D640	D641	D642	D643	D644	D645	D646	D647	D648	D649	D64A	D64B	D64C
	Char.	淖	淖	淖	淖	淖	淖	淖	淖	淖	淖	淖	淖	淖	淖	淖	淖
73F0	BIG5	D64D	D64E	D64F	D650	D651	D652	D653	D654	D655	D656	D657	D658	D659	D65A		
	Char.	焮	焮	焮	焮	焮	焮	焮	焮	焮	焮	焮	焮	焮	焮		
7440	BIG5		D65B	D65C	D65D	D65E	D65F	D660	D661	D662	D663	D664	D665	D666	D667	D668	D669
	Char.		狝	狝	狝	狝	狝	狝	狝	狝	狝	狝	狝	狝	狝	狝	狝

Table B-3 IBM à Big5 Conversion Table (continued)

IBM		+ 0	+ 1	+ 2	+ 3	+ 4	+ 5	+ 6	+ 7	+ 8	+ 9	+ A	+ B	+ C	+ D	+ E	+ F
7450	BIG5	D66A	D66B	D66C	D66D	D66E	D66F	D670	D671	D672	D673	D674	D675	D676	D677	D678	D679
	Char.	旅	琚	瑀	瑛	瑛	琬	琰	琰	琰	琰	琰	琰	琰	琰	琰	琰
7460	BIG5	D67A	D67B	D67C	D67D	D67E	D6A1	D6A2	D6A3	D6A4	D6A5	D6A6	D6A7	D6A8	D6A9	D6AA	D6AB
	Char.	時	奮	痲	痲	痲	痲	痲	痲	痲	痲	毗	盪	睽	睽	睽	睽
7470	BIG5	D6AC	D6AD	D6AE	D6AF	D6B0	D6B1	D6B2	D6B3	D6B4	D6B5	D6B6	D6B7	D6B8	D6B9	D6BA	D6BB
	Char.	睽	睽	睽	睽	睽	睽	睽	硃	硃	硃	硃	硃	硃	硃	硃	硃
7480	BIG5		D6BC	D6BD	D6BE	D6BF	D6C0	D6C1	D6C2	D6C3	D6C4	D6C5	D6C6	D6C7	D6C8	D6C9	D6CA
	Char.		裊	裊	裊	裊	裊	裊	柴	柴	柴	柴	柴	柴	穿	穿	穿
7490	BIG5	D6CB	D6CC	D6CD	D6CE	D6CF	D6D0	D6D1	D6D2	D6D3	D6D4	D6D5	D6D6	D6D7	D6D8	D6D9	D6DA
	Char.	筭	筭	筭	筭	筭	筭	筭	筭	筭	筭	筭	筭	筭	筭	筭	筭
74A0	BIG5	D6DB	D6DC	D6DD	D6DE	D6DF	D6E0	D6E1	D6E2	D6E3	D6E4	D6E5	D6E6	D6E7	D6E8	D6E9	D6EA
	Char.	筭	筭	筭	筭	筭	筭	筭	筭	筭	筭	筭	筭	筭	筭	筭	筭
74B0	BIG5	D6EB	D6EC	D6ED	D6EE	D6EF	D6F0	D6F1	D6F2	D6F3	D6F4	D6F5	D6F6	D6F7	D6F8	D6F9	D6FA
	Char.	絢	絢	絢	絢	絢	絢	絢	絢	絢	絢	絢	絢	絢	絢	絢	絢
74C0	BIG5	D6FB	D6FC	D6FD	D6FE	D740	D741	D742	D743	D744	D745	D746	D747	D748	D749	D74A	D74B
	Char.	斐	斐	斐	斐	斐	斐	斐	斐	斐	斐	斐	斐	斐	斐	斐	斐
74D0	BIG5	D74C	D74D	D74E	D74F	D750	D751	D752	D753	D754	D755	D756	D757	D758	D759	D75A	D75B
	Char.	脛	脛	脛	脛	脛	脛	脛	脛	脛	脛	脛	脛	脛	脛	脛	脛
74E0	BIG5	D75C	D75D	D75E	D75F	D760	D761	D762	D763	D764	D765	D766	D767	D768	D769	D76A	D76B
	Char.	莖	莖	莖	莖	莖	莖	莖	莖	莖	莖	莖	莖	莖	莖	莖	莖
74F0	BIG5	D76C	D76D	D76E	D76F	D770	D771	D772	D773	D774	D775	D776	D777	D778	D779		
	Char.	莖	莖	莖	莖	莖	莖	莖	莖	莖	莖	莖	莖	莖	莖		

Table B-3 IBM à Big5 Conversion Table (continued)

IBM		+ 0	+ 1	+ 2	+ 3	+ 4	+ 5	+ 6	+ 7	+ 8	+ 9	+ A	+ B	+ C	+ D	+ E	+ F
7540	BIG5		D77A	D77B	D77C	D77D	D77E	D7A1	D7A2	D7A3	D7A4	D7A5	D7A6	D7A7	D7A8	D7A9	D7AA
	Char.		莛	慮	慮	虻	虻	虻	蛸	蛸	蛸	蛸	蛸	蛸	蛸	蛸	蛸
7550	BIG5	D7AB	D7AC	D7AD	D7AE	D7AF	D7B0	D7B1	D7B2	D7B3	D7B4	D7B5	D7B6	D7B7	D7B8	D7B9	D7BA
	Char.	蚋	蜚	蚋	蚋	蚋	蚋	蚋	蚋	蚋	蚋	蚋	蚋	蚋	蚋	蚋	蚋
7560	BIG5	D7BB	D7BC	D7BD	D7BE	D7BF	D7C0	D7C1	D7C2	D7C3	D7C4	D7C5	D7C6	D7C7	D7C8	D7C9	D7CA
	Char.	襖	襖	襖	襖	襖	襖	襖	襖	襖	襖	襖	襖	襖	襖	襖	襖
7570	BIG5	D7CB	D7CC	D7CD	D7CE	D7CF	D7D0	D7D1	D7D2	D7D3	D7D4	D7D5	D7D6	D7D7	D7D8	D7D9	D7DA
	Char.	諺	諺	諺	諺	諺	諺	諺	諺	諺	諺	諺	諺	諺	諺	諺	諺
7580	BIG5		D7DB	D7DC	D7DD	D7DE	D7DF	D7E0	D7E1	D7E2	D7E3	D7E4	D7E5	D7E6	D7E7	D7E8	D7E9
	Char.		軛	軛	軛	軛	軛	軛	軛	軛	軛	軛	軛	軛	軛	軛	軛
7590	BIG5	D7EA	D7EB	D7EC	D7ED	D7EE	D7EF	D7F0	D7F1	D7F2	D7F3	D7F4	D7F5	D7F6	D7F7	D7F8	D7F9
	Char.	駟	駟	駟	駟	駟	駟	駟	駟	駟	駟	駟	駟	駟	駟	駟	駟
75A0	BIG5	D7FA	D7FB	D7FC	D7FD	D7FE	D840	D841	D842	D843	D844	D845	D846	D847	D848	D849	D84A
	Char.	鉉	鉉	鉉	鉉	鉉	鉉	鉉	鉉	鉉	鉉	鉉	鉉	鉉	鉉	鉉	鉉
75B0	BIG5	D84B	D84C	D84D	D84E	D84F	D850	D851	D852	D853	D854	D855	D856	D857	D858	D859	D85A
	Char.	倫	倫	倫	倫	倫	倫	倫	倫	倫	倫	倫	倫	倫	倫	倫	倫
75C0	BIG5	D85B	D85C	D85D	D85E	D85F	D860	D861	D862	D863	D864	D865	D866	D867	D868	D869	D86A
	Char.	傑	傑	傑	傑	傑	傑	傑	傑	傑	傑	傑	傑	傑	傑	傑	傑
75D0	BIG5	D86B	D86C	D86D	D86E	D86F	D870	D871	D872	D873	D874	D875	D876	D877	D878	D879	D87A
	Char.	嗚	嗚	嗚	嗚	嗚	嗚	嗚	嗚	嗚	嗚	嗚	嗚	嗚	嗚	嗚	嗚
75E0	BIG5	D87B	D87C	D87D	D87E	D8A1	D8A2	D8A3	D8A4	D8A5	D8A6	D8A7	D8A8	D8A9	D8AA	D8AB	D8AC
	Char.	嗚	圖	圖	圖	圖	圖	圖	圖	圖	圖	圖	圖	圖	圖	圖	圖

Table B-3 IBM à Big5 Conversion Table (continued)

IBM		+ 0	+ 1	+ 2	+ 3	+ 4	+ 5	+ 6	+ 7	+ 8	+ 9	+ A	+ B	+ C	+ D	+ E	+ F
75F0	BIG5	D8AD	D8AE	D8AF	D8B0	D8B1	D8B2	D8B3	D8B4	D8B5	D8B6	D8B7	D8B8	D8B9	D8BA		
	Char.	墻	墻	墻	墻	墻	墻	墻	墻	墻	墻	墻	墻	墻	墻		
7640	BIG5		D8BB	D8BC	D8BD	D8BE	D8BF	D8C0	D8C1	D8C2	D8C3	D8C4	D8C5	D8C6	D8C7	D8C8	D8C9
	Char.		嫫	嫫	嫫	嫫	嫫	嫫	嫫	嫫	嫫	嫫	嫫	嫫	嫫	嫫	嫫
7650	BIG5	D8CA	D8CB	D8CC	D8CD	D8CE	D8CF	D8D0	D8D1	D8D2	D8D3	D8D4	D8D5	D8D6	D8D7	D8D8	D8D9
	Char.	嫫	嫫	嫫	嫫	嫫	嫫	嫫	嫫	嫫	嫫	嫫	嫫	嫫	嫫	嫫	嫫
7660	BIG5	D8DA	D8DB	D8DC	D8DD	D8DE	D8DF	D8E0	D8E1	D8E2	D8E3	D8E4	D8E5	D8E6	D8E7	D8E8	D8E9
	Char.	嶠	嶠	嶠	嶠	嶠	嶠	嶠	嶠	嶠	嶠	嶠	嶠	嶠	嶠	嶠	嶠
7670	BIG5	D8EA	D8EB	D8EC	D8ED	D8EE	D8EF	D8F0	D8F1	D8F2	D8F3	D8F4	D8F5	D8F6	D8F7	D8F8	D8F9
	Char.	嶠	嶠	嶠	嶠	嶠	嶠	嶠	嶠	嶠	嶠	嶠	嶠	嶠	嶠	嶠	嶠
7680	BIG5		D8FA	D8FB	D8FC	D8FD	D8FE	D940	D941	D942	D943	D944	D945	D946	D947	D948	D949
	Char.		嶠	嶠	嶠	嶠	嶠	嶠	嶠	嶠	嶠	嶠	嶠	嶠	嶠	嶠	嶠
7690	BIG5	D94A	D94B	D94C	D94D	D94E	D94F	D950	D951	D952	D953	D954	D955	D956	D957	D958	D959
	Char.	嶠	嶠	嶠	嶠	嶠	嶠	嶠	嶠	嶠	嶠	嶠	嶠	嶠	嶠	嶠	嶠
76A0	BIG5	D95A	D95B	D95C	D95D	D95E	D95F	D960	D961	D962	D963	D964	D965	D966	D967	D968	D969
	Char.	嶠	嶠	嶠	嶠	嶠	嶠	嶠	嶠	嶠	嶠	嶠	嶠	嶠	嶠	嶠	嶠
76B0	BIG5	D96A	D96B	D96C	D96D	D96E	D96F	D970	D971	D972	D973	D974	D975	D976	D977	D978	D979
	Char.	嶠	嶠	嶠	嶠	嶠	嶠	嶠	嶠	嶠	嶠	嶠	嶠	嶠	嶠	嶠	嶠
76C0	BIG5	D97A	D97B	D97C	D97D	D97E	D9A1	D9A2	D9A3	D9A4	D9A5	D9A6	D9A7	D9A8	D9A9	D9AA	D9AB
	Char.	嶠	嶠	嶠	嶠	嶠	嶠	嶠	嶠	嶠	嶠	嶠	嶠	嶠	嶠	嶠	嶠
76D0	BIG5	D9AC	D9AD	D9AE	D9AF	D9B0	D9B1	D9B2	D9B3	D9B4	D9B5	D9B6	D9B7	D9B8	D9B9	D9BA	D9BB
	Char.	嶠	嶠	嶠	嶠	嶠	嶠	嶠	嶠	嶠	嶠	嶠	嶠	嶠	嶠	嶠	嶠

Table B-3 IBM à Big5 Conversion Table (continued)

IBM		+ 0	+ 1	+ 2	+ 3	+ 4	+ 5	+ 6	+ 7	+ 8	+ 9	+ A	+ B	+ C	+ D	+ E	+ F
76E0	BIG5	D9BC	D9BD	D9BE	D9BF	D9C0	D9C1	D9C2	D9C3	D9C4	D9C5	D9C6	D9C7	D9C8	D9C9	D9CA	D9CB
	Char.	棋	樑	栲	楸	楸	楸	楸	楸	楸	楸	楸	楸	楸	楸	楸	楸
76F0	BIG5	D9CC	D9CD	D9CE	D9CF	D9D0	D9D1	D9D2	D9D3	D9D4	D9D5	D9D6	D9D7	D9D8	D9D9		
	Char.	楸	樑	精	樞	樞	桴	楸	排	桐	楸	樞	楸	楸	楸		
7740	BIG5		D9DA	D9DB	D9DC	D9DD	D9DE	D9DF	D9E0	D9E1	D9E2	D9E3	D9E4	D9E5	D9E6	D9E7	D9E8
	Char.		欵	欵	欵	歛	殞	殞	殞	殞	殞	殞	殞	殞	殞	殞	殞
7750	BIG5	D9E9	D9EA	D9EB	D9EC	D9ED	D9EE	D9EF	D9F0	D9F1	D9F2	D9F3	D9F4	D9F5	D9F6	D9F7	D9F8
	Char.	涪	涪	涪	涪	涪	涪	涪	涪	涪	涪	涪	涪	涪	涪	涪	涪
7760	BIG5	D9F9	D9FA	D9FB	D9FC	D9FD	D9FE	DA40	DA41	DA42	DA43	DA44	DA45	DA46	DA47	DA48	DA49
	Char.	涪	涪	涪	涪	涪	涪	涪	涪	涪	涪	涪	涪	涪	涪	涪	涪
7770	BIG5	DA4A	DA4B	DA4C	DA4D	DA4E	DA4F	DA50	DA51	DA52	DA53	DA54	DA55	DA56	DA57	DA58	DA59
	Char.	涪	涪	涪	涪	涪	涪	涪	涪	涪	涪	涪	涪	涪	涪	涪	涪
7780	BIG5		DA5A	DA5B	DA5C	DA5D	DA5E	DA5F	DA60	DA61	DA62	DA63	DA64	DA65	DA66	DA67	DA68
	Char.		焯	焯	焯	焯	焯	焯	焯	焯	焯	焯	焯	焯	焯	焯	焯
7790	BIG5	DA69	DA6A	DA6B	DA6C	DA6D	DA6E	DA6F	DA70	DA71	DA72	DA73	DA74	DA75	DA76	DA77	DA78
	Char.	焯	焯	焯	焯	焯	焯	焯	焯	焯	焯	焯	焯	焯	焯	焯	焯
77A0	BIG5	DA79	DA7A	DA7B	DA7C	DA7D	DA7E	DAA1	DAA2	DAA3	DAA4	DAA5	DAA6	DAA7	DAA8	DAA9	DAAA
	Char.	焯	焯	焯	焯	焯	焯	焯	焯	焯	焯	焯	焯	焯	焯	焯	焯
77B0	BIG5	DAAB	DAAC	DAAD	DAAE	DAAF	DAB0	DAB1	DAB2	DAB3	DAB4	DAB5	DAB6	DAB7	DAB8	DAB9	DABA
	Char.	焯	焯	焯	焯	焯	焯	焯	焯	焯	焯	焯	焯	焯	焯	焯	焯
77C0	BIG5	DABB	DABC	DABD	DABE	DABF	DAC0	DAC1	DAC2	DAC3	DAC4	DAC5	DAC6	DAC7	DAC8	DAC9	DACA
	Char.	焯	焯	焯	焯	焯	焯	焯	焯	焯	焯	焯	焯	焯	焯	焯	焯

Table B-3 IBM à Big5 Conversion Table (continued)

IBM		+ 0	+ 1	+ 2	+ 3	+ 4	+ 5	+ 6	+ 7	+ 8	+ 9	+ A	+ B	+ C	+ D	+ E	+ F
77D0	BIG5	DACB	DACC	DACD	DACE	DACF	DAD0	DAD1	DAD2	DAD3	DAD4	DAD5	DAD6	DAD7	DAD8	DAD9	DADA
	Char.	碓	确	砦	誓	碑	砧	砧	碱	振	稷	皓	稂	稊	稗	稊	稊
77E0	BIG5	DADB	DADC	DADD	DADE	DADF	DAE0	DAE1	DAE2	DAE3	DAE4	DAE5	DAE6	DAE7	DAE8	DAE9	DAEA
	Char.	拏	竦	竦	筊	筊	筊	筊	筊	筊	筊	筊	筊	筊	筊	筊	筊
77F0	BIG5	DAEB	DAEC	DAED	DAEE	DAEF	DAF0	DAF1	DAF2	DAF3	DAF4	DAF5	DAF6	DAF7	DAF8		
	Char.	紵	紵	紵	紵	紵	紵	紵	紵	紵	紵	紵	紵	紵	紵		
7840	BIG5		DAF9	DAFA	DAFB	DAFC	DAFD	DAFE	DB40	DB41	DB42	DB43	DB44	DB45	DB46	DB47	DB48
	Char.		絛	絛	絛	絛	絛	絛	絛	絛	絛	絛	絛	絛	絛	絛	絛
7850	BIG5	DB49	DB4A	DB4B	DB4C	DB4D	DB4E	DB4F	DB50	DB51	DB52	DB53	DB54	DB55	DB56	DB57	DB58
	Char.	齒	脛	脛	脛	脛	脛	脛	脛	脛	脛	脛	脛	脛	脛	脛	脛
7860	BIG5	DB59	DB5A	DB5B	DB5C	DB5D	DB5E	DB5F	DB60	DB61	DB62	DB63	DB64	DB65	DB66	DB67	DB68
	Char.	絛	絛	絛	絛	絛	絛	絛	絛	絛	絛	絛	絛	絛	絛	絛	絛
7870	BIG5	DB69	DB6A	DB6B	DB6C	DB6D	DB6E	DB6F	DB70	DB71	DB72	DB73	DB74	DB75	DB76	DB77	DB78
	Char.	菴	菴	菴	菴	菴	菴	菴	菴	菴	菴	菴	菴	菴	菴	菴	菴
7880	BIG5		DB79	DB7A	DB7B	DB7C	DB7D	DB7E	DBA1	DBA2	DBA3	DBA4	DBA5	DBA6	DBA7	DBA8	DBA9
	Char.		菴	菴	菴	菴	菴	菴	菴	菴	菴	菴	菴	菴	菴	菴	菴
7890	BIG5	DBAA	DBAB	DBAC	DBAD	DBAE	DBAF	DBB0	DBB1	DBB2	DBB3	DBB4	DBB5	DBB6	DBB7	DBB8	DBB9
	Char.	蕞	蕞	蕞	蕞	蕞	蕞	蕞	蕞	蕞	蕞	蕞	蕞	蕞	蕞	蕞	蕞
78A0	BIG5	DBBA	DBBB	DBBC	DBBD	DBBE	DBBF	DBC0	DBC1	DBC2	DBC3	DBC4	DBC5	DBC6	DBC7	DBC8	DBC9
	Char.	蚶	蚶	蚶	蚶	蚶	蚶	蚶	蚶	蚶	蚶	蚶	蚶	蚶	蚶	蚶	蚶
78B0	BIG5	DBCA	DBCB	DBCC	DBCD	DBCE	DBCF	DBD0	DBD1	DBD2	DBD3	DBD4	DBD5	DBD6	DBD7	DBD8	DBD9
	Char.	褚	褚	褚	褚	褚	褚	褚	褚	褚	褚	褚	褚	褚	褚	褚	褚

Table B-3 IBM à Big5 Conversion Table (continued)

IBM		+ 0	+ 1	+ 2	+ 3	+ 4	+ 5	+ 6	+ 7	+ 8	+ 9	+ A	+ B	+ C	+ D	+ E	+ F
78C0	BIG5	DBDA	DBDB	DBDC	DBDD	DBDE	DBDF	DBE0	DBE1	DBE2	DBE3	DBE4	DBE5	DBE6	DBE7	DBE8	DBE9
	Char.	詒	訶	詘	詠	詒	詒	詒	詒	詒	詒	詒	詒	詒	詒	詒	詒
78D0	BIG5	DBEA	DBEB	DBEC	DBED	DBEE	DBEF	DBF0	DBF1	DBF2	DBF3	DBF4	DBF5	DBF6	DBF7	DBF8	DBF9
	Char.	賁	賁	賁	賁	賁	賁	賁	賁	賁	賁	賁	賁	賁	賁	賁	賁
78E0	BIG5	DBFA	DBFB	DBFC	DBFD	DBFE	DC40	DC41	DC42	DC43	DC44	DC45	DC46	DC47	DC48	DC49	DC4A
	Char.	附	跗	軚	軚	軚	軚	軚	軚	軚	軚	軚	軚	軚	軚	軚	軚
78F0	BIG5	DC4B	DC4C	DC4D	DC4E	DC4F	DC50	DC51	DC52	DC53	DC54	DC55	DC56	DC57	DC58		
	Char.	軚	軚	軚	軚	軚	軚	軚	軚	軚	軚	軚	軚	軚	軚		
7940	BIG5		DC59	DC5A	DC5B	DC5C	DC5D	DC5E	DC5F	DC60	DC61	DC62	DC63	DC64	DC65	DC66	DC67
	Char.		鄒	鄒	鄒	鄒	鄒	鄒	鄒	鄒	鄒	鄒	鄒	鄒	鄒	鄒	鄒
7950	BIG5	DC68	DC69	DC6A	DC6B	DC6C	DC6D	DC6E	DC6F	DC70	DC71	DC72	DC73	DC74	DC75	DC76	DC77
	Char.	鄒	鄒	鄒	鄒	鄒	鄒	鄒	鄒	鄒	鄒	鄒	鄒	鄒	鄒	鄒	鄒
7960	BIG5	DC78	DC79	DC7A	DC7B	DC7C	DC7D	DC7E	DCA1	DCA2	DCA3	DCA4	DCA5	DCA6	DCA7	DCA8	DCA9
	Char.	鄒	鄒	鄒	鄒	鄒	鄒	鄒	鄒	鄒	鄒	鄒	鄒	鄒	鄒	鄒	鄒
7970	BIG5	DCAA	DCAB	DCAC	DCAD	DCAE	DCAF	DCB0	DCB1	DCB2	DCB3	DCB4	DCB5	DCB6	DCB7	DCB8	DCB9
	Char.	鄒	鄒	鄒	鄒	鄒	鄒	鄒	鄒	鄒	鄒	鄒	鄒	鄒	鄒	鄒	鄒
7980	BIG5		DCBA	DCBB	DCBC	DCBD	DCBE	DCBF	DCC0	DCC1	DCC2	DCC3	DCC4	DCC5	DCC6	DCC7	DCC8
	Char.		鄒	鄒	鄒	鄒	鄒	鄒	鄒	鄒	鄒	鄒	鄒	鄒	鄒	鄒	鄒
7990	BIG5	DCC9	DCCA	DCCB	DCCC	DCCD	DCCE	DCCF	DCD0	DCD1	DCD2	DCD3	DCD4	DCD5	DCD6	DCD7	DCD8
	Char.	鄒	鄒	鄒	鄒	鄒	鄒	鄒	鄒	鄒	鄒	鄒	鄒	鄒	鄒	鄒	鄒
79A0	BIG5	DCD9	DCDA	DCDB	DCDC	DCDD	DCDE	DCDF	DCE0	DCE1	DCE2	DCE3	DCE4	DCE5	DCE6	DCE7	DCE8
	Char.	鄒	鄒	鄒	鄒	鄒	鄒	鄒	鄒	鄒	鄒	鄒	鄒	鄒	鄒	鄒	鄒

Table B-3 IBM à Big5 Conversion Table (continued)

IBM		+ 0	+ 1	+ 2	+ 3	+ 4	+ 5	+ 6	+ 7	+ 8	+ 9	+ A	+ B	+ C	+ D	+ E	+ F
79B0	BIG5	DCE9	DCEA	DCEB	DCEC	DCED	DCEE	DCEF	DCF0	DCF1	DCF2	DCF3	DCF4	DCF5	DCF6	DCF7	DCF8
	Char.	塏	塔	塒	塓	塔	塕	塖	塗	塘	塙	塚	塛	塜	塝	塞	塟
79C0	BIG5	DCF9	DCFA	DCFB	DCFC	DCFD	DCFE	DD40	DD41	DD42	DD43	DD44	DD45	DD46	DD47	DD48	DD49
	Char.	媮	媹	媺	媻	媽	媿	媾	媿	媾	媿	媾	媿	媾	媿	媾	媿
79D0	BIG5	DD4A	DD4B	DD4C	DD4D	DD4E	DD4F	DD50	DD51	DD52	DD53	DD54	DD55	DD56	DD57	DD58	DD59
	Char.	嶺	嶸	嶹	嶺	嶸	嶹	嶺	嶸	嶹	嶺	嶸	嶹	嶺	嶸	嶹	嶺
79E0	BIG5	DD5A	DD5B	DD5C	DD5D	DD5E	DD5F	DD60	DD61	DD62	DD63	DD64	DD65	DD66	DD67	DD68	DD69
	Char.	嶺	嶸	嶹	嶺	嶸	嶹	嶺	嶸	嶹	嶺	嶸	嶹	嶺	嶸	嶹	嶺
79F0	BIG5	DD6A	DD6B	DD6C	DD6D	DD6E	DD6F	DD70	DD71	DD72	DD73	DD74	DD75	DD76	DD77		
	Char.	嶺	嶸	嶹	嶺	嶸	嶹	嶺	嶸	嶹	嶺	嶸	嶹	嶺	嶸	嶹	嶺
7A40	BIG5		DD78	DD79	DD7A	DD7B	DD7C	DD7D	DD7E	DDA1	DDA2	DDA3	DDA4	DDA5	DDA6	DDA7	DDA8
	Char.		擧	擧	擧	擧	擧	擧	擧	擧	擧	擧	擧	擧	擧	擧	擧
7A50	BIG5	DDA9	DDAA	DDAB	DDAC	DDAD	DDAE	DDAF	DDB0	DDB1	DDB2	DDB3	DDB4	DDB5	DDB6	DDB7	DDB8
	Char.	擧	擧	擧	擧	擧	擧	擧	擧	擧	擧	擧	擧	擧	擧	擧	擧
7A60	BIG5	DDB9	DDBA	DDBB	DDBC	DDBD	DDBE	DDBF	DDC0	DDC1	DDC2	DDC3	DDC4	DDC5	DDC6	DDC7	DDC8
	Char.	擧	擧	擧	擧	擧	擧	擧	擧	擧	擧	擧	擧	擧	擧	擧	擧
7A70	BIG5	DDC9	DDCA	DDCB	DDCC	DDCD	DDCE	DDCF	DDD0	DDD1	DDD2	DDD3	DDD4	DDD5	DDD6	DDD7	DDD8
	Char.	擧	擧	擧	擧	擧	擧	擧	擧	擧	擧	擧	擧	擧	擧	擧	擧
7A80	BIG5		DDD9	DDDA	DDDB	DDDC	DDDD	DDDE	DDDF	DDE0	DDE1	DDE2	DDE3	DDE4	DDE5	DDE6	DDE7
	Char.		擧	擧	擧	擧	擧	擧	擧	擧	擧	擧	擧	擧	擧	擧	擧
7A90	BIG5	DDE8	DDE9	DDEA	DDEB	DDEC	DDED	DDEE	DDEF	DDF0	DDF1	DDF2	DDF3	DDF4	DDF5	DDF6	DDF7
	Char.	擧	擧	擧	擧	擧	擧	擧	擧	擧	擧	擧	擧	擧	擧	擧	擧

Table B-3 IBM à Big5 Conversion Table (continued)

IBM		+ 0	+ 1	+ 2	+ 3	+ 4	+ 5	+ 6	+ 7	+ 8	+ 9	+ A	+ B	+ C	+ D	+ E	+ F
7AA0	BIG5	DDF8	DDF9	DDFA	DDFB	DDFC	DDFD	DDFE	DE40	DE41	DE42	DE43	DE44	DE45	DE46	DE47	DE48
	Char.	歎	歛	歎	殞	殼	駝	駝	駝	駝	稔	漉	滾	瀆	澆	潘	溲
7AB0	BIG5	DE49	DE4A	DE4B	DE4C	DE4D	DE4E	DE4F	DE50	DE51	DE52	DE53	DE54	DE55	DE56	DE57	DE58
	Char.	濂	滌	澆	溱	溱	溱	溱	溱	溱	溱	溱	溱	溱	溱	溱	溱
7AC0	BIG5	DE59	DE5A	DE5B	DE5C	DE5D	DE5E	DE5F	DE60	DE61	DE62	DE63	DE64	DE65	DE66	DE67	DE68
	Char.	溲	溲	溲	溲	溲	溲	溲	溲	溲	溲	溲	溲	溲	溲	溲	溲
7AD0	BIG5	DE69	DE6A	DE6B	DE6C	DE6D	DE6E	DE6F	DE70	DE71	DE72	DE73	DE74	DE75	DE76	DE77	DE78
	Char.	灑	灑	灑	灑	灑	灑	灑	灑	灑	灑	灑	灑	灑	灑	灑	灑
7AE0	BIG5	DE79	DE7A	DE7B	DE7C	DE7D	DE7E	DEA1	DEA2	DEA3	DEA4	DEA5	DEA6	DEA7	DEA8	DEA9	DEAA
	Char.	灑	灑	灑	灑	灑	灑	灑	灑	灑	灑	灑	灑	灑	灑	灑	灑
7AF0	BIG5	DEAB	DEAC	DEAD	DEAE	DEAF	DEB0	DEB1	DEB2	DEB3	DEB4	DEB5	DEB6	DEB7	DEB8		
	Char.	獠	獠	獠	獠	獠	獠	獠	獠	獠	獠	獠	獠	獠	獠		
7B40	BIG5		DEB9	DEBA	DEBB	DEBC	DEBD	DEBE	DEBF	DEC0	DEC1	DEC2	DEC3	DEC4	DEC5	DEC6	DEC7
	Char.		璦	璦	璦	璦	璦	璦	璦	璦	璦	璦	璦	璦	璦	璦	璦
7B50	BIG5	DEC8	DEC9	DECA	DECB	DECC	DECD	DECE	DECF	DED0	DED1	DED2	DED3	DED4	DED5	DED6	DED7
	Char.	瘡	瘡	瘡	瘡	瘡	瘡	瘡	瘡	瘡	瘡	瘡	瘡	瘡	瘡	瘡	瘡
7B60	BIG5	DED8	DED9	DEDA	DEDB	DEDC	DEDD	DEDE	DEDF	DEE0	DEE1	DEE2	DEE3	DEE4	DEE5	DEE6	DEE7
	Char.	睽	睽	睽	睽	睽	睽	睽	睽	睽	睽	睽	睽	睽	睽	睽	睽
7B70	BIG5	DEE8	DEE9	DEEA	DEEB	DEEC	DEED	DEEE	DEEF	DEF0	DEF1	DEF2	DEF3	DEF4	DEF5	DEF6	DEF7
	Char.	礪	礪	礪	礪	礪	礪	礪	礪	礪	礪	礪	礪	礪	礪	礪	礪
7B80	BIG5		DEF8	DEF9	DEFA	DEFB	DEFC	DEFD	DEFE	DF40	DF41	DF42	DF43	DF44	DF45	DF46	DF47
	Char.		稊	稊	稊	稊	稊	稊	稊	稊	稊	稊	稊	稊	稊	稊	稊
7B90	BIG5	DF48	DF49	DF4A	DF4B	DF4C	DF4D	DF4E	DF4F	DF50	DF51	DF52	DF53	DF54	DF55	DF56	DF57
	Char.	箒	箒	箒	箒	箒	箒	箒	箒	箒	箒	箒	箒	箒	箒	箒	箒

Table B-3 IBM à Big5 Conversion Table (continued)

IBM		+ 0	+ 1	+ 2	+ 3	+ 4	+ 5	+ 6	+ 7	+ 8	+ 9	+ A	+ B	+ C	+ D	+ E	+ F
7BA0	BIG5	DF58	DF59	DF5A	DF5B	DF5C	DF5D	DF5E	DF5F	DF60	DF61	DF62	DF63	DF64	DF65	DF66	DF67
	Char.	縵	練	緯	練	縵	縵	縵	縵	縵	縵	縵	縵	縵	縵	縵	縵
7BB0	BIG5	DF68	DF69	DF6A	DF6B	DF6C	DF6D	DF6E	DF6F	DF70	DF71	DF72	DF73	DF74	DF75	DF76	DF77
	Char.	罽	罽	罽	罽	罽	罽	罽	罽	罽	罽	罽	罽	罽	罽	罽	罽
7BC0	BIG5	DF78	DF79	DF7A	DF7B	DF7C	DF7D	DF7E	DFA1	DFA2	DFA3	DFA4	DFA5	DFA6	DFA7	DFA8	DFA9
	Char.	膾	膾	膾	膾	膾	膾	膾	膾	膾	膾	膾	膾	膾	膾	膾	膾
7BD0	BIG5	DFAA	DFAB	DFAC	DFAD	DFAE	DFAF	DFB0	DFB1	DFB2	DFB3	DFB4	DFB5	DFB6	DFB7	DFB8	DFB9
	Char.	蒞	蒞	蒞	蒞	蒞	蒞	蒞	蒞	蒞	蒞	蒞	蒞	蒞	蒞	蒞	蒞
7BE0	BIG5	DFBA	DFBB	DFBC	DFBD	DFBE	DFBF	DFC0	DFC1	DFC2	DFC3	DFC4	DFC5	DFC6	DFC7	DFC8	DFC9
	Char.	蒺	蒺	蒺	蒺	蒺	蒺	蒺	蒺	蒺	蒺	蒺	蒺	蒺	蒺	蒺	蒺
7BF0	BIG5	DFCA	DFCB	DFCC	DFCD	DFCE	DFCF	DFD0	DFD1	DFD2	DFD3	DFD4	DFD5	DFD6	DFD7		
	Char.	蒻	蒻	蒻	蒻	蒻	蒻	蒻	蒻	蒻	蒻	蒻	蒻	蒻	蒻		
7C40	BIG5		DFD8	DFD9	DFDA	DFDB	DFDC	DFDD	DFDE	DFDF	DFE0	DFE1	DFE2	DFE3	DFE4	DFE5	DFE6
	Char.		蒽	蒽	蒽	蒽	蒽	蒽	蒽	蒽	蒽	蒽	蒽	蒽	蒽	蒽	蒽
7C50	BIG5	DFE7	DFE8	DFE9	DFEA	DFEB	DFEC	DFED	DFEE	DFEF	DFF0	DFF1	DFF2	DFF3	DFF4	DFF5	DFF6
	Char.	蒹	蒹	蒹	蒹	蒹	蒹	蒹	蒹	蒹	蒹	蒹	蒹	蒹	蒹	蒹	蒹
7C60	BIG5	DFF7	DFF8	DFF9	FFFA	DFFB	DFFC	DFFD	DFFE	E040	E041	E042	E043	E044	E045	E046	E047
	Char.	蒺	蒺	蒺	蒺	蒺	蒺	蒺	蒺	蒺	蒺	蒺	蒺	蒺	蒺	蒺	蒺
7C70	BIG5	E048	E049	E04A	E04B	E04C	E04D	E04E	E04F	E050	E051	E052	E053	E054	E055	E056	E057
	Char.	蒻	蒻	蒻	蒻	蒻	蒻	蒻	蒻	蒻	蒻	蒻	蒻	蒻	蒻	蒻	蒻
7C80	BIG5		E058	E059	E05A	E05B	E05C	E05D	E05E	E05F	E060	E061	E062	E063	E064	E065	E066
	Char.		蒻	蒻	蒻	蒻	蒻	蒻	蒻	蒻	蒻	蒻	蒻	蒻	蒻	蒻	蒻

Table B-3 IBM à Big5 Conversion Table (continued)

IBM		+ 0	+ 1	+ 2	+ 3	+ 4	+ 5	+ 6	+ 7	+ 8	+ 9	+ A	+ B	+ C	+ D	+ E	+ F
7C90	BIG5	E067	E068	E069	E06A	E06B	E06C	E06D	E06E	E06F	E070	E071	E072	E073	E074	E075	E076
	Char.	跣	蹠	跣	跣	跣	跣	跣	跣	跣	跣	跣	跣	跣	跣	跣	跣
7CA0	BIG5	E077	E078	E079	E07A	E07B	E07C	E07D	E07E	E0A1	E0A2	E0A3	E0A4	E0A5	E0A6	E0A7	E0A8
	Char.	輻	輻	輻	輻	輻	輻	輻	輻	輻	輻	輻	輻	輻	輻	輻	輻
7CB0	BIG5	E0A9	E0AA	E0AB	E0AC	E0AD	E0AE	E0AF	E0B0	E0B1	E0B2	E0B3	E0B4	E0B5	E0B6	E0B7	E0B8
	Char.	鄔	鄔	鄔	鄔	鄔	鄔	鄔	鄔	鄔	鄔	鄔	鄔	鄔	鄔	鄔	鄔
7CC0	BIG5	E0B9	E0BA	E0BB	E0BC	E0BD	E0BE	E0BF	E0C0	E0C1	E0C2	E0C3	E0C4	E0C5	E0C6	E0C7	E0C8
	Char.	鈞	鈞	鈞	鈞	鈞	鈞	鈞	鈞	鈞	鈞	鈞	鈞	鈞	鈞	鈞	鈞
7CD0	BIG5	E0C9	E0CA	E0CB	E0CC	E0CD	E0CE	E0CF	E0D0	E0D1	E0D2	E0D3	E0D4	E0D5	E0D6	E0D7	E0D8
	Char.	鈞	鈞	鈞	鈞	鈞	鈞	鈞	鈞	鈞	鈞	鈞	鈞	鈞	鈞	鈞	鈞
7CE0	BIG5	E0D9	E0DA	E0DB	E0DC	E0DD	E0DE	E0DF	E0E0	E0E1	E0E2	E0E3	E0E4	E0E5	E0E6	E0E7	E0E8
	Char.	龔	龔	龔	龔	龔	龔	龔	龔	龔	龔	龔	龔	龔	龔	龔	龔
7CF0	BIG5	E0E9	E0EA	E0EB	E0EC	E0ED	E0EE	E0EF	E0F0	E0F1	E0F2	E0F3	E0F4	E0F5	E0F6		
	Char.	龔	龔	龔	龔	龔	龔	龔	龔	龔	龔	龔	龔	龔	龔		
7D40	BIG5		E0F7	E0F8	E0F9	E0FA	E0FB	E0FC	E0FD	E0FE	E140	E141	E142	E143	E144	E145	E146
	Char.		龔	龔	龔	龔	龔	龔	龔	龔	龔	龔	龔	龔	龔	龔	龔
7D50	BIG5	E147	E148	E149	E14A	E14B	E14C	E14D	E14E	E14F	E150	E151	E152	E153	E154	E155	E156
	Char.	龔	龔	龔	龔	龔	龔	龔	龔	龔	龔	龔	龔	龔	龔	龔	龔
7D60	BIG5	E157	E158	E159	E15A	E15B	E15C	E15D	E15E	E15F	E160	E161	E162	E163	E164	E165	E166
	Char.	龔	龔	龔	龔	龔	龔	龔	龔	龔	龔	龔	龔	龔	龔	龔	龔
7D70	BIG5	E167	E168	E169	E16A	E16B	E16C	E16D	E16E	E16F	E170	E171	E172	E173	E174	E175	E176
	Char.	龔	龔	龔	龔	龔	龔	龔	龔	龔	龔	龔	龔	龔	龔	龔	龔

Table B-3 IBM à Big5 Conversion Table (continued)

IBM		+ 0	+ 1	+ 2	+ 3	+ 4	+ 5	+ 6	+ 7	+ 8	+ 9	+ A	+ B	+ C	+ D	+ E	+ F
7D80	BIG5		E177	E178	E179	E17A	E17B	E17C	E17D	E17E	E1A1	E1A2	E1A3	E1A4	E1A5	E1A6	E1A7
	Char.		嫵	嫵	嫵	嫵	嫵	嫵	嫵	嫵	寔	寔	嶂	嶂	嶂	嶂	嶂
7D90	BIG5	E1A8	E1A9	E1AA	E1AB	E1AC	E1AD	E1AE	E1AF	E1B0	E1B1	E1B2	E1B3	E1B4	E1B5	E1B6	E1B7
	Char.	嶂	嶂	嶂	嶂	嶂	嶂	嶂	嶂	嶂	嶂	嶂	嶂	嶂	嶂	嶂	嶂
7DA0	BIG5	E1B8	E1B9	E1BA	E1BB	E1BC	E1BD	E1BE	E1BF	E1C0	E1C1	E1C2	E1C3	E1C4	E1C5	E1C6	E1C7
	Char.	嶂	嶂	嶂	嶂	嶂	嶂	嶂	嶂	嶂	嶂	嶂	嶂	嶂	嶂	嶂	嶂
7DB0	BIG5	E1C8	E1C9	E1CA	E1CB	E1CC	E1CD	E1CE	E1CF	E1D0	E1D1	E1D2	E1D3	E1D4	E1D5	E1D6	E1D7
	Char.	嶂	嶂	嶂	嶂	嶂	嶂	嶂	嶂	嶂	嶂	嶂	嶂	嶂	嶂	嶂	嶂
7DC0	BIG5	E1D8	E1D9	E1DA	E1DB	E1DC	E1DD	E1DE	E1DF	E1E0	E1E1	E1E2	E1E3	E1E4	E1E5	E1E6	E1E7
	Char.	嶂	嶂	嶂	嶂	嶂	嶂	嶂	嶂	嶂	嶂	嶂	嶂	嶂	嶂	嶂	嶂
7DD0	BIG5	E1E8	E1E9	E1EA	E1EB	E1EC	E1ED	E1EE	E1EF	E1F0	E1F1	E1F2	E1F3	E1F4	E1F5	E1F6	E1F7
	Char.	嶂	嶂	嶂	嶂	嶂	嶂	嶂	嶂	嶂	嶂	嶂	嶂	嶂	嶂	嶂	嶂
7DE0	BIG5	E1F8	E1F9	E1FA	E1FB	E1FC	E1FD	E1FE	E240	E241	E242	E243	E244	E245	E246	E247	E248
	Char.	嶂	嶂	嶂	嶂	嶂	嶂	嶂	嶂	嶂	嶂	嶂	嶂	嶂	嶂	嶂	嶂
7DF0	BIG5	E249	E24A	E24B	E24C	E24D	E24E	E24F	E250	E251	E252	E253	E254	E255	E256		
	Char.	嶂	嶂	嶂	嶂	嶂	嶂	嶂	嶂	嶂	嶂	嶂	嶂	嶂	嶂		
7E40	BIG5		E257	E258	E259	E25A	E25B	E25C	E25D	E25E	E25F	E260	E261	E262	E263	E264	E265
	Char.		嶂	嶂	嶂	嶂	嶂	嶂	嶂	嶂	嶂	嶂	嶂	嶂	嶂	嶂	嶂
7E50	BIG5	E266	E267	E268	E269	E26A	E26B	E26C	E26D	E26E	E26F	E270	E271	E272	E273	E274	E275
	Char.	嶂	嶂	嶂	嶂	嶂	嶂	嶂	嶂	嶂	嶂	嶂	嶂	嶂	嶂	嶂	嶂
7E60	BIG5	E276	E277	E278	E279	E27A	E27B	E27C	E27D	E27E	E2A1	E2A2	E2A3	E2A4	E2A5	E2A6	E2A7
	Char.	嶂	嶂	嶂	嶂	嶂	嶂	嶂	嶂	嶂	嶂	嶂	嶂	嶂	嶂	嶂	嶂

Table B-3 IBM à Big5 Conversion Table (continued)

IBM		+ 0	+ 1	+ 2	+ 3	+ 4	+ 5	+ 6	+ 7	+ 8	+ 9	+ A	+ B	+ C	+ D	+ E	+ F
7E70	BIG5	E2A8	E2A9	E2AA	E2AB	E2AC	E2AD	E2AE	E2AF	E2B0	E2B1	E2B2	E2B3	E2B4	E2B5	E2B6	E2B7
	Char.	淮	激	滌	漑	漑	漑	漑	漑	漑	漑	漑	漑	漑	漑	漑	漑
7E80	BIG5		E2B8	E2B9	E2BA	E2BB	E2BC	E2BD	E2BE	E2BF	E2C0	E2C1	E2C2	E2C3	E2C4	E2C5	E2C6
	Char.		滌	湯	熇	熇	熇	熇	熇	熇	熇	熇	熇	熇	熇	熇	勝
7E90	BIG5	E2C7	E2C8	E2C9	E2CA	E2CB	E2CC	E2CD	E2CE	E2CF	E2D0	E2D1	E2D2	E2D3	E2D4	E2D5	E2D6
	Char.	轄	備	擲	獸	獍	獍	獍	瑤	瑤	瑤	瑤	瑤	瑤	瑤	甌	甌
7EA0	BIG5	E2D7	E2D8	E2D9	E2DA	E2DB	E2DC	E2DD	E2DE	E2DF	E2E0	E2E1	E2E2	E2E3	E2E4	E2E5	E2E6
	Char.	贅	腫	瘡	瘡	瘡	瘡	瘡	瘡	瘡	瘡	瘡	瘡	瘡	瘡	瘡	諭
7EB0	BIG5	E2E7	E2E8	E2E9	E2EA	E2EB	E2EC	E2ED	E2EE	E2EF	E2F0	E2F1	E2F2	E2F3	E2F4	E2F5	E2F6
	Char.	贅	贅	擗	擗	擗	擗	擗	擗	擗	擗	擗	擗	擗	擗	擗	碼
7EC0	BIG5	E2F7	E2F8	E2F9	E2FA	E2FB	E2FC	E2FD	E2FE	E340	E341	E342	E343	E344	E345	E346	E347
	Char.	礪	禘	禘	禘	禘	禘	禘	禘	禘	禘	禘	禘	福	概	稽	稷
7ED0	BIG5	E348	E349	E34A	E34B	E34C	E34D	E34E	E34F	E350	E351	E352	E353	E354	E355	E356	E357
	Char.	籩	籩	籩	籩	籩	籩	籩	籩	籩	籩	籩	籩	籩	籩	籩	籩
7EE0	BIG5	E358	E359	E35A	E35B	E35C	E35D	E35E	E35F	E360	E361	E362	E363	E364	E365	E366	E367
	Char.	算	籩	籩	籩	筭	筭	筭	糗	糗	糗	縉	縉	縉	縉	縉	縉
7EF0	BIG5	E368	E369	E36A	E36B	E36C	E36D	E36E	E36F	E370	E371	E372	E373	E374	E375		
	Char.	縉	縉	縉	縉	縉	縉	縉	縉	縉	縉	縉	縉	縉	縉		
7F40	BIG5		E376	E377	E378	E379	E37A	E37B	E37C	E37D	E37E	E3A1	E3A2	E3A3	E3A4	E3A5	E3A6
	Char.		縉	縉	縉	縉	縉	縉	縉	縉	縉	縉	縉	縉	縉	縉	縉
7F50	BIG5	E3A7	E3A8	E3A9	E3AA	E3AB	E3AC	E3AD	E3AE	E3AF	E3B0	E3B1	E3B2	E3B3	E3B4	E3B5	E3B6
	Char.	臄	臄	臄	臄	臄	臄	臄	莠	莠	蒺	蒺	蒺	蒺	蒺	蒺	蒺

Table B-3 IBM à Big5 Conversion Table (continued)

IBM	+ 0	+ 1	+ 2	+ 3	+ 4	+ 5	+ 6	+ 7	+ 8	+ 9	+ A	+ B	+ C	+ D	+ E	+ F	
7F60	BIG5	E3B7	E3B8	E3B9	E3BA	E3BB	E3BC	E3BD	E3BE	E3BF	E3C0	E3C1	E3C2	E3C3	E3C4	E3C5	E3C6
	Char.	蒨	藁	著	蕁	蒿	蒲	蓐	蕨	葳	蕘	蕚	蕛	蕜	蕝	蕞	蕟
7F70	BIG5	E3C7	E3C8	E3C9	E3CA	E3CB	E3CC	E3CD	E3CE	E3CF	E3D0	E3D1	E3D2	E3D3	E3D4	E3D5	E3D6
	Char.	蒯	蒸	蒹	蒺	蒻	蒼	蒽	蒾	蒿	蒾	蒿	蒾	蒿	蒾	蒿	蒾
7F80	BIG5		E3D7	E3D8	E3D9	E3DA	E3DB	E3DC	E3DD	E3DE	E3DF	E3E0	E3E1	E3E2	E3E3	E3E4	E3E5
	Char.		螻	蝓	蝓	蝓	蝓	蝓	蝓	蝓	蝓	蝓	蝓	蝓	蝓	蝓	蝓
7F90	BIG5	E3E6	E3E7	E3E8	E3E9	E3EA	E3EB	E3EC	E3ED	E3EE	E3EF	E3F0	E3F1	E3F2	E3F3	E3F4	E3F5
	Char.	蚶	蚶	蚶	蚶	蚶	蚶	蚶	蚶	蚶	蚶	蚶	蚶	蚶	蚶	蚶	蚶
7FA0	BIG5	E3F6	E3F7	E3F8	E3F9	E3FA	E3FB	E3FC	E3FD	E3FE	E440	E441	E442	E443	E444	E445	E446
	Char.	襖	襖	襖	襖	襖	襖	襖	襖	襖	襖	襖	襖	襖	襖	襖	襖
7FB0	BIG5	E447	E448	E449	E44A	E44B	E44C	E44D	E44E	E44F	E450	E451	E452	E453	E454	E455	E456
	Char.	𧄂	𧄂	𧄂	𧄂	𧄂	𧄂	𧄂	𧄂	𧄂	𧄂	𧄂	𧄂	𧄂	𧄂	𧄂	𧄂
7FC0	BIG5	E457	E458	E459	E45A	E45B	E45C	E45D	E45E	E45F	E460	E461	E462	E463	E464	E465	E466
	Char.	踉	踉	踉	踉	踉	踉	踉	踉	踉	踉	踉	踉	踉	踉	踉	踉
7FD0	BIG5	E467	E468	E469	E46A	E46B	E46C	E46D	E46E	E46F	E470	E471	E472	E473	E474	E475	E476
	Char.	𧄃	𧄃	𧄃	𧄃	𧄃	𧄃	𧄃	𧄃	𧄃	𧄃	𧄃	𧄃	𧄃	𧄃	𧄃	𧄃
7FE0	BIG5	E477	E478	E479	E47A	E47B	E47C	E47D	E47E	E4A1	E4A2	E4A3	E4A4	E4A5	E4A6	E4A7	E4A8
	Char.	銖	銖	銖	銖	銖	銖	銖	銖	銖	銖	銖	銖	銖	銖	銖	銖
7FF0	BIG5	E4A9	E4AA	E4AB	E4AC	E4AD	E4AE	E4AF	E4B0	E4B1	E4B2	E4B3	E4B4	E4B5	E4B6		
	Char.	銖	銖	銖	銖	銖	銖	銖	銖	銖	銖	銖	銖	銖	銖		
8040	BIG5		E4B7	E4B8	E4B9	E4BA	E4BB	E4BC	E4BD	E4BE	E4BF	E4C0	E4C1	E4C2	E4C3	E4C4	E4C5
	Char.		銖	銖	銖	銖	銖	銖	銖	銖	銖	銖	銖	銖	銖	銖	銖
8050	BIG5	E4C6	E4C7	E4C8	E4C9	E4CA	E4CB	E4CC	E4CD	E4CE	E4CF	E4D0	E4D1	E4D2	E4D3	E4D4	E4D5
	Char.	𧄄	𧄄	𧄄	𧄄	𧄄	𧄄	𧄄	𧄄	𧄄	𧄄	𧄄	𧄄	𧄄	𧄄	𧄄	𧄄

Table B-3 IBM à Big5 Conversion Table (continued)

IBM		+ 0	+ 1	+ 2	+ 3	+ 4	+ 5	+ 6	+ 7	+ 8	+ 9	+ A	+ B	+ C	+ D	+ E	+ F
8060	BIG5	E4D6	E4D7	E4D8	E4D9	E4DA	E4DB	E4DC	E4DD	E4DE	E4DF	E4E0	E4E1	E4E2	E4E3	E4E4	E4E5
	Char.	駁	馮	羣	駁	駁	鬃	鬃	鬃	軀	軀	鈞	缸	鴉	鴉	鴉	麩
8070	BIG5	E4E6	E4E7	E4E8	E4E9	E4EA	E4EB	E4EC	E4ED	E4EE	E4EF	E4F0	E4F1	E4F2	E4F3	E4F4	E4F5
	Char.	儻	儻	儻	儻	儻	儻	儻	儻	儻	儻	儻	儻	儻	儻	儻	儻
8080	BIG5		E4F6	E4F7	E4F8	E4F9	E4FA	E4FB	E4FC	E4FD	E4FE	E540	E541	E542	E543	E544	E545
	Char.		噉	噉	噉	噉	噉	噉	噉	噉	噉	噉	噉	噉	噉	噉	噉
8090	BIG5	E546	E547	E548	E549	E54A	E54B	E54C	E54D	E54E	E54F	E550	E551	E552	E553	E554	E555
	Char.	噉	噉	噉	噉	噉	噉	噉	噉	噉	噉	噉	噉	噉	噉	噉	噉
80A0	BIG5	E556	E557	E558	E559	E55A	E55B	E55C	E55D	E55E	E55F	E560	E561	E562	E563	E564	E565
	Char.	嫵	嫵	嫵	嫵	嫵	嫵	嫵	嫵	嫵	嫵	嫵	嫵	嫵	嫵	嫵	嫵
80B0	BIG5	E566	E567	E568	E569	E56A	E56B	E56C	E56D	E56E	E56F	E570	E571	E572	E573	E574	E575
	Char.	嶠	嶠	嶠	嶠	嶠	嶠	嶠	嶠	嶠	嶠	嶠	嶠	嶠	嶠	嶠	嶠
80C0	BIG5	E576	E577	E578	E579	E57A	E57B	E57C	E57D	E57E	E5A1	E5A2	E5A3	E5A4	E5A5	E5A6	E5A7
	Char.	嶠	嶠	嶠	嶠	嶠	嶠	嶠	嶠	嶠	嶠	嶠	嶠	嶠	嶠	嶠	嶠
80D0	BIG5	E5A8	E5A9	E5AA	E5AB	E5AC	E5AD	E5AE	E5AF	E5B0	E5B1	E5B2	E5B3	E5B4	E5B5	E5B6	E5B7
	Char.	嶠	嶠	嶠	嶠	嶠	嶠	嶠	嶠	嶠	嶠	嶠	嶠	嶠	嶠	嶠	嶠
80E0	BIG5	E5B8	E5B9	E5BA	E5BB	E5BC	E5BD	E5BE	E5BF	E5C0	E5C1	E5C2	E5C3	E5C4	E5C5	E5C6	E5C7
	Char.	嶠	嶠	嶠	嶠	嶠	嶠	嶠	嶠	嶠	嶠	嶠	嶠	嶠	嶠	嶠	嶠
80F0	BIG5	E5C8	E5C9	E5CA	E5CB	E5CC	E5CD	E5CE	E5CF	E5D0	E5D1	E5D2	E5D3	E5D4	E5D5		
	Char.	嶠	嶠	嶠	嶠	嶠	嶠	嶠	嶠	嶠	嶠	嶠	嶠	嶠	嶠		
8140	BIG5		E5D6	E5D7	E5D8	E5D9	E5DA	E5DB	E5DC	E5DD	E5DE	E5DF	E5E0	E5E1	E5E2	E5E3	E5E4
	Char.		嶠	嶠	嶠	嶠	嶠	嶠	嶠	嶠	嶠	嶠	嶠	嶠	嶠	嶠	嶠

Table B-3 IBM à Big5 Conversion Table (continued)

IBM		+ 0	+ 1	+ 2	+ 3	+ 4	+ 5	+ 6	+ 7	+ 8	+ 9	+ A	+ B	+ C	+ D	+ E	+ F
8150	BIG5	E5E5	E5E6	E5E7	E5E8	E5E9	E5EA	E5EB	E5EC	E5ED	E5EE	E5EF	E5F0	E5F1	E5F2	E5F3	E5F4
	Char.	樽	棧	棟	檉	樺	標	櫛	檉	櫛	櫛	龔	獻	殞	殞	帶	鳩
8160	BIG5	E5F5	E5F6	E5F7	E5F8	E5F9	E5FA	E5FB	E5FC	E5FD	E5FE	E640	E641	E642	E643	E644	E645
	Char.	穉	麩	麩	麓	穎	榮	滂	滂	漬	瀆	澍	澍	澍	澍	澍	澍
8170	BIG5	E646	E647	E648	E649	E64A	E64B	E64C	E64D	E64E	E64F	E650	E651	E652	E653	E654	E655
	Char.	瀟	瀟	瀟	瀟	濺	濺	濺	濺	濺	濺	濺	濺	濺	濺	濺	濺
8180	BIG5		E656	E657	E658	E659	E65A	E65B	E65C	E65D	E65E	E65F	E660	E661	E662	E663	E664
	Char.		潛	潛	潛	潛	潛	潛	潛	潛	潛	潛	潛	潛	潛	潛	潛
8190	BIG5	E665	E666	E667	E668	E669	E66A	E66B	E66C	E66D	E66E	E66F	E670	E671	E672	E673	E674
	Char.	燻	燻	燻	燻	燻	燻	燻	燻	燻	燻	燻	燻	燻	燻	燻	燻
81A0	BIG5	E675	E676	E677	E678	E679	E67A	E67B	E67C	E67D	E67E	E6A1	E6A2	E6A3	E6A4	E6A5	E6A6
	Char.	獒	獒	獒	獒	獒	獒	獒	獒	獒	獒	獒	獒	獒	獒	獒	獒
81B0	BIG5	E6A7	E6A8	E6A9	E6AA	E6AB	E6AC	E6AD	E6AE	E6AF	E6B0	E6B1	E6B2	E6B3	E6B4	E6B5	E6B6
	Char.	璣	璣	璣	璣	璣	璣	璣	璣	璣	璣	璣	璣	璣	璣	璣	璣
81C0	BIG5	E6B7	E6B8	E6B9	E6BA	E6BB	E6BC	E6BD	E6BE	E6BF	E6C0	E6C1	E6C2	E6C3	E6C4	E6C5	E6C6
	Char.	瘧	瘧	瘧	瘧	瘧	瘧	瘧	瘧	瘧	瘧	瘧	瘧	瘧	瘧	瘧	瘧
81D0	BIG5	E6C7	E6C8	E6C9	E6CA	E6CB	E6CC	E6CD	E6CE	E6CF	E6D0	E6D1	E6D2	E6D3	E6D4	E6D5	E6D6
	Char.	礪	礪	礪	礪	礪	礪	礪	礪	礪	礪	礪	礪	礪	礪	礪	礪
81E0	BIG5	E6D7	E6D8	E6D9	E6DA	E6DB	E6DC	E6DD	E6DE	E6DF	E6E0	E6E1	E6E2	E6E3	E6E4	E6E5	E6E6
	Char.	籩	籩	籩	籩	籩	籩	籩	籩	籩	籩	籩	籩	籩	籩	籩	籩
81F0	BIG5	E6E7	E6E8	E6E9	E6EA	E6EB	E6EC	E6ED	E6EE	E6EF	E6F0	E6F1	E6F2	E6F3	E6F4		
	Char.	緇	緇	緇	緇	緇	緇	緇	緇	緇	緇	緇	緇	緇	緇		

Table B-3 IBM à Big5 Conversion Table (continued)

IBM		+ 0	+ 1	+ 2	+ 3	+ 4	+ 5	+ 6	+ 7	+ 8	+ 9	+ A	+ B	+ C	+ D	+ E	+ F
8240	BIG5		E6F5	E6F6	E6F7	E6F8	E6F9	E6FA	E6FB	E6FC	E6FD	E6FE	E740	E741	E742	E743	E744
	Char.		滌	翫	撥	翬	翦	翹	聘	聯	陸	腓	膊	膾	腰	脛	隹
8250	BIG5	E745	E746	E747	E748	E749	E74A	E74B	E74C	E74D	E74E	E74F	E750	E751	E752	E753	E754
	Char.	舖	館	髒	艙	艘	鯨	鯊	密	菘	蔞	蔀	黃	葭	蓑	鹿	族
8260	BIG5	E755	E756	E757	E758	E759	E75A	E75B	E75C	E75D	E75E	E75F	E760	E761	E762	E763	E764
	Char.	焯	藝	菽	菽	薦	蕪	蕪	蕪	蕪	蕪	蕪	蕪	蕪	蕪	蕪	蕪
8270	BIG5	E765	E766	E767	E768	E769	E76A	E76B	E76C	E76D	E76E	E76F	E770	E771	E772	E773	E774
	Char.	煮	蘆	蒨	蘆	蔞	蔞	蔞	蔞	蔞	蔞	蔞	唯	菘	蔞	蔞	蔞
8280	BIG5		E775	E776	E777	E778	E779	E77A	E77B	E77C	E77D	E77E	E7A1	E7A2	E7A3	E7A4	E7A5
	Char.		蕪	蕪	蕪	蔞	蔞	蔞	蔞	蔞	蔞	號	蝗	蟬	蟬	蟬	蟬
8290	BIG5	E7A6	E7A7	E7A8	E7A9	E7AA	E7AB	E7AC	E7AD	E7AE	E7AF	E7B0	E7B1	E7B2	E7B3	E7B4	E7B5
	Char.	蟬	蟬	蟬	蟬	蟬	蟬	蟬	蟬	蟬	蟬	蟬	蟬	蟬	蟬	蟬	蟬
82A0	BIG5	E7B6	E7B7	E7B8	E7B9	E7BA	E7BB	E7BC	E7BD	E7BE	E7BF	E7C0	E7C1	E7C2	E7C3	E7C4	E7C5
	Char.	蟬	蟬	蟬	蟬	蟬	蟬	蟬	蟬	蟬	蟬	蟬	蟬	蟬	蟬	蟬	蟬
82B0	BIG5	E7C6	E7C7	E7C8	E7C9	E7CA	E7CB	E7CC	E7CD	E7CE	E7CF	E7D0	E7D1	E7D2	E7D3	E7D4	E7D5
	Char.	襪	襪	襪	襪	襪	襪	襪	襪	襪	襪	襪	襪	襪	襪	襪	襪
82C0	BIG5	E7D6	E7D7	E7D8	E7D9	E7DA	E7DB	E7DC	E7DD	E7DE	E7DF	E7E0	E7E1	E7E2	E7E3	E7E4	E7E5
	Char.	諛	諛	諛	諛	諛	諛	諛	諛	諛	諛	諛	諛	諛	諛	諛	諛
82D0	BIG5	E7E6	E7E7	E7E8	E7E9	E7EA	E7EB	E7EC	E7ED	E7EE	E7EF	E7F0	E7F1	E7F2	E7F3	E7F4	E7F5
	Char.	諛	諛	諛	諛	諛	諛	諛	諛	諛	諛	諛	諛	諛	諛	諛	諛
82E0	BIG5	E7F6	E7F7	E7F8	E7F9	E7FA	E7FB	E7FC	E7FD	E7FE	E840	E841	E842	E843	E844	E845	E846
	Char.	諛	諛	諛	諛	諛	諛	諛	諛	諛	諛	諛	諛	諛	諛	諛	諛
82F0	BIG5	E847	E848	E849	E84A	E84B	E84C	E84D	E84E	E84F	E850	E851	E852	E853	E854		
	Char.	諛	諛	諛	諛	諛	諛	諛	諛	諛	諛	諛	諛	諛	諛		

Table B-3 IBM à Big5 Conversion Table (continued)

IBM		+ 0	+ 1	+ 2	+ 3	+ 4	+ 5	+ 6	+ 7	+ 8	+ 9	+ A	+ B	+ C	+ D	+ E	+ F
8340	BIG5		E855	E856	E857	E858	E859	E85A	E85B	E85C	E85D	E85E	E85F	E860	E861	E862	E863
	Char.		鄮	鄮	鄮	鄮	鄮	鄮	醅	醅	醅	醅	醅	醅	醅	鉞	鉞
8350	BIG5	E864	E865	E866	E867	E868	E869	E86A	E86B	E86C	E86D	E86E	E86F	E870	E871	E872	E873
	Char.	鋈	鉅	鉅	鉅	鉅	鉅	鉅	錒	錒	錒	錒	錒	錒	錒	錒	鎔
8360	BIG5	E874	E875	E876	E877	E878	E879	E87A	E87B	E87C	E87D	E87E	E8A1	E8A2	E8A3	E8A4	E8A5
	Char.	鎔	鎔	鎔	鎔	鎔	鎔	鎔	錒	錒	錒	錒	錒	錒	錒	錒	錒
8370	BIG5	E8A6	E8A7	E8A8	E8A9	E8AA	E8AB	E8AC	E8AD	E8AE	E8AF	E8B0	E8B1	E8B2	E8B3	E8B4	E8B5
	Char.	閻	閻	閻	閻	閻	閻	閻	霽	霽	霽	靚	靚	靚	靚	靚	靚
8380	BIG5		E8B6	E8B7	E8B8	E8B9	E8BA	E8BB	E8BC	E8BD	E8BE	E8BF	E8C0	E8C1	E8C2	E8C3	E8C4
	Char.		頰	頰	頰	頰	頰	頰	頰	頰	頰	頰	餗	餗	餗	餗	餗
8390	BIG5	E8C5	E8C6	E8C7	E8C8	E8C9	E8CA	E8CB	E8CC	E8CD	E8CE	E8CF	E8D0	E8D1	E8D2	E8D3	E8D4
	Char.	餗	駟	駟	駟	駟	駟	駟	駟	駟	駟	駟	駟	駟	駟	駟	駟
83A0	BIG5	E8D5	E8D6	E8D7	E8D8	E8D9	E8DA	E8DB	E8DC	E8DD	E8DE	E8DF	E8E0	E8E1	E8E2	E8E3	E8E4
	Char.	髻	髮	髮	髮	髮	魴	魴	魴	魴	魴	魴	魴	魴	魴	魴	鷓
83B0	BIG5	E8E5	E8E6	E8E7	E8E8	E8E9	E8EA	E8EB	E8EC	E8ED	E8EE	E8EF	E8F0	E8F1	E8F2	E8F3	E8F4
	Char.	鳩	鳩	鳩	鳩	鳩	鳩	鳩	鳩	鳩	鳩	鳩	鷹	鷹	鷹	鷹	鷹
83C0	BIG5	E8F5	E8F6	E8F7	E8F8	E8F9	E8FA	E8FB	E8FC	E8FD	E8FE	E940	E941	E942	E943	E944	E945
	Char.	儻	儻	儻	儻	儻	儻	儻	嚙	嚙	嚙	嚙	嚙	嚙	嚙	嚙	嚙
83D0	BIG5	E946	E947	E948	E949	E94A	E94B	E94C	E94D	E94E	E94F	E950	E951	E952	E953	E954	E955
	Char.	嗽	團	團	團	團	團	團	墜	墜	墜	墜	墜	墜	墜	墜	墜
83E0	BIG5	E956	E957	E958	E959	E95A	E95B	E95C	E95D	E95E	E95F	E960	E961	E962	E963	E964	E965
	Char.	嫩	嬾	嬾	嬾	嬾	嬾	嬾	嬾	嬾	嬾	嬾	嬾	嬾	嬾	嬾	業

Table B-3 IBM à Big5 Conversion Table (continued)

IBM		+ 0	+ 1	+ 2	+ 3	+ 4	+ 5	+ 6	+ 7	+ 8	+ 9	+ A	+ B	+ C	+ D	+ E	+ F
83F0	BIG5	E966	E967	E968	E969	E96A	E96B	E96C	E96D	E96E	E96F	E970	E971	E972	E973		
	Char.	𪛗	𪛘	𪛙	𪛚	𪛛	𪛜	𪛝	𪛞	𪛟	𪛠	𪛡	𪛢	𪛣	𪛤		
8440	BIG5		E974	E975	E976	E977	E978	E979	E97A	E97B	E97C	E97D	E97E	E9A1	E9A2	E9A3	E9A4
	Char.		𪛥	𪛦	𪛧	𪛨	𪛩	𪛪	𪛫	𪛬	𪛭	𪛮	𪛯	𪛰	𪛱	𪛲	𪛳
8450	BIG5	E9A5	E9A6	E9A7	E9A8	E9A9	E9AA	E9AB	E9AC	E9AD	E9AE	E9AF	E9B0	E9B1	E9B2	E9B3	E9B4
	Char.	𪛴	𪛵	𪛶	𪛷	𪛸	𪛹	𪛺	𪛻	𪛼	𪛽	𪛾	𪛿	𪜀	𪜁	𪜂	𪜃
8460	BIG5	E9B5	E9B6	E9B7	E9B8	E9B9	E9BA	E9BB	E9BC	E9BD	E9BE	E9BF	E9C0	E9C1	E9C2	E9C3	E9C4
	Char.	𪜄	𪜅	𪜆	𪜇	𪜈	𪜉	𪜊	𪜋	𪜌	𪜍	𪜎	𪜏	𪜐	𪜑	𪜒	𪜓
8470	BIG5	E9C5	E9C6	E9C7	E9C8	E9C9	E9CA	E9CB	E9CC	E9CD	E9CE	E9CF	E9D0	E9D1	E9D2	E9D3	E9D4
	Char.	𪜔	𪜕	𪜖	𪜗	𪜘	𪜙	𪜚	𪜛	𪜜	𪜝	𪜞	𪜟	𪜠	𪜡	𪜢	𪜣
8480	BIG5		E9D5	E9D6	E9D7	E9D8	E9D9	E9DA	E9DB	E9DC	E9DD	E9DE	E9DF	E9E0	E9E1	E9E2	E9E3
	Char.		𪜤	𪜥	𪜦	𪜧	𪜨	𪜩	𪜪	𪜫	𪜬	𪜭	𪜮	𪜯	𪜰	𪜱	𪜲
8490	BIG5	E9E4	E9E5	E9E6	E9E7	E9E8	E9E9	E9EA	E9EB	E9EC	E9ED	E9EE	E9EF	E9F0	E9F1	E9F2	E9F3
	Char.	𪜳	𪜴	𪜵	𪜶	𪜷	𪜸	𪜹	𪜺	𪜻	𪜼	𪜽	𪜾	𪜿	𪝀	𪝁	𪝂
84A0	BIG5	E9F4	E9F5	E9F6	E9F7	E9F8	E9F9	E9FA	E9FB	E9FC	E9FD	E9FE	EA40	EA41	EA42	EA43	EA44
	Char.	𪝃	𪝄	𪝅	𪝆	𪝇	𪝈	𪝉	𪝊	𪝋	𪝌	𪝍	𪝎	𪝏	𪝐	𪝑	𪝒
84B0	BIG5	EA45	EA46	EA47	EA48	EA49	EA4A	EA4B	EA4C	EA4D	EA4E	EA4F	EA50	EA51	EA52	EA53	EA54
	Char.	𪝓	𪝔	𪝕	𪝖	𪝗	𪝘	𪝙	𪝚	𪝛	𪝜	𪝝	𪝞	𪝟	𪝠	𪝡	𪝢
84C0	BIG5	EA55	EA56	EA57	EA58	EA59	EA5A	EA5B	EA5C	EA5D	EA5E	EA5F	EA60	EA61	EA62	EA63	EA64
	Char.	𪝣	𪝤	𪝥	𪝦	𪝧	𪝨	𪝩	𪝪	𪝫	𪝬	𪝭	𪝮	𪝯	𪝰	𪝱	𪝲
84D0	BIG5	EA65	EA66	EA67	EA68	EA69	EA6A	EA6B	EA6C	EA6D	EA6E	EA6F	EA70	EA71	EA72	EA73	EA74
	Char.	𪝳	𪝴	𪝵	𪝶	𪝷	𪝸	𪝹	𪝺	𪝻	𪝼	𪝽	𪝾	𪝿	𪞀	𪞁	𪞂

Table B-3 IBM à Big5 Conversion Table (continued)

IBM		+ 0	+ 1	+ 2	+ 3	+ 4	+ 5	+ 6	+ 7	+ 8	+ 9	+ A	+ B	+ C	+ D	+ E	+ F
84E0	BIG5	EA75	EA76	EA77	EA78	EA79	EA7A	EA7B	EA7C	EA7D	EA7E	EAA1	EAA2	EAA3	EAA4	EAA5	EAA6
	Char.	盒	曠	曠	曠	曠	曠	曠	曠	曠	曠	曠	曠	曠	曠	曠	曠
84F0	BIG5	EAA7	EAA8	EAA9	EAAA	EAAB	EAAC	EAAD	EAAE	EAAF	EAB0	EAB1	EAB2	EAB3	EAB4		
	Char.	磻	暫	礪	碇	礪	礪	礪	礪	礪	礪	礪	礪	礪	礪		
8540	BIG5		EAB5	EAB6	EAB7	EAB8	EAB9	EABA	EABB	EABC	EABD	EABE	EABF	EAC0	EAC1	EAC2	EAC3
	Char.		籜	籜	籜	籜	籜	籜	籜	籜	籜	籜	籜	籜	籜	籜	籜
8550	BIG5	EAC4	EAC5	EAC6	EAC7	EAC8	EAC9	EACA	EACB	EACC	EACD	EACE	EACF	EAD0	EAD1	EAD2	EAD3
	Char.	籜	籜	籜	籜	籜	籜	籜	籜	籜	籜	籜	籜	籜	籜	籜	籜
8560	BIG5	EAD4	EAD5	EAD6	EAD7	EAD8	EAD9	EADA	EADB	EADC	EADD	EADE	EADF	EAE0	EAE1	EAE2	EAE3
	Char.	緝	緝	緝	緝	緝	緝	緝	緝	緝	緝	緝	緝	緝	緝	緝	緝
8570	BIG5	EAE4	EAE5	EAE6	EAE7	EAE8	EAE9	EAEA	EAEB	EAEC	EAED	EAEF	EAEF	EAF0	EAF1	EAF2	EAF3
	Char.	翳	榜	構	聯	職	隣	曉	贖	睥	瞭	膳	膳	膳	膳	腳	腫
8580	BIG5		EAF4	EAF5	EAF6	EAF7	EAF8	EAF9	EAF0	EAFB	EAFD	EAFE	EAFE	EB40	EB41	EB42	EB43
	Char.		艸	榜	艘	艦	藻	薄	董	蒲	蕈	蕈	蕈	蕈	蕈	蕈	蕈
8590	BIG5	EB44	EB45	EB46	EB47	EB48	EB49	EB4A	EB4B	EB4C	EB4D	EB4E	EB4F	EB50	EB51	EB52	EB53
	Char.	蕈	蕈	蕈	蕈	蕈	蕈	蕈	蕈	蕈	蕈	蕈	蕈	蕈	蕈	蕈	蕈
85A0	BIG5	EB54	EB55	EB56	EB57	EB58	EB59	EB5A	EB5B	EB5C	EB5D	EB5E	EB5F	EB60	EB61	EB62	EB63
	Char.	蕈	蕈	蕈	蕈	蕈	蕈	蕈	蕈	蕈	蕈	蕈	蕈	蕈	蕈	蕈	蕈
85B0	BIG5	EB64	EB65	EB66	EB67	EB68	EB69	EB6A	EB6B	EB6C	EB6D	EB6E	EB6F	EB70	EB71	EB72	EB73
	Char.	蠅	蟻	螻	螞	螞	螞	螞	螞	螞	螞	螞	螞	螞	螞	螞	螞
85C0	BIG5	EB74	EB75	EB76	EB77	EB78	EB79	EB7A	EB7B	EB7C	EB7D	EB7E	EBA1	EBA2	EBA3	EBA4	EBA5
	Char.	褰	褰	褰	褰	褰	褰	褰	褰	褰	褰	褰	褰	褰	褰	褰	褰

Table B-3 IBM à Big5 Conversion Table (continued)

IBM		+ 0	+ 1	+ 2	+ 3	+ 4	+ 5	+ 6	+ 7	+ 8	+ 9	+ A	+ B	+ C	+ D	+ E	+ F
85D0	BIG5	EBA6	EBA7	EBA8	EBA9	EBA A	EBAB	EBAC	EBAD	EBAE	EBAF	EBB0	EBB1	EBB2	EBB3	EBB4	EBB5
	Char.	諛	諤	諛	諛	諛	諛	諛	諛	諛	諛	諛	獬	獬	獬	贈	責
85E0	BIG5	EBB6	EBB7	EBB8	EBB9	EBBA	EBBB	EBBC	EBBD	EBBE	EBBF	EBC0	EBC1	EBC2	EBC3	EBC4	EBC5
	Char.	輝	賸	賸	賸	賸	賸	賸	賸	賸	賸	賸	賸	賸	賸	賸	賸
85F0	BIG5	EBC6	EBC7	EBC8	EBC9	EBCA	EBCB	EBC C	EBCD	EBCE	EBCF	EBD0	EBD1	EBD2	EBD3		
	Char.	踰	踰	踰	踰	踰	踰	踰	踰	踰	踰	踰	踰	踰	踰		
8640	BIG5		EBD4	EBD5	EBD6	EBD7	EBD8	EBD9	EBDA	EBDB	EBDC	EBDD	EBDE	EBDF	EBE0	EBE1	EBE2
	Char.		躑	躑	躑	躑	躑	躑	躑	躑	躑	躑	躑	躑	躑	躑	躑
8650	BIG5	EBE3	EBE4	EBE5	EBE6	EBE7	EBE8	EBE9	EBEA	EBE B	EBEC	EBED	EBEE	EBEF	EBF0	EBF1	EBF2
	Char.	錯	錯	錯	錯	錯	錯	錯	錯	錯	錯	錯	錯	錯	錯	錯	錯
8660	BIG5	EBF3	EBF4	EBF5	EBF6	EBF7	EBF8	EBF9	EBFA	EBFB	EBFC	EBFD	EBFE	EC40	EC41	EC42	EC43
	Char.	鋸	鋸	鋸	鋸	鋸	鋸	鋸	鋸	鋸	鋸	鋸	鋸	鋸	鋸	鋸	鋸
8670	BIG5	EC44	EC45	EC46	EC47	EC48	EC49	EC4A	EC4B	EC4C	EC4D	EC4E	EC4F	EC50	EC51	EC52	EC53
	Char.	鑿	鑿	鑿	鑿	鑿	鑿	鑿	鑿	鑿	鑿	鑿	鑿	鑿	鑿	鑿	鑿
8680	BIG5		EC54	EC55	EC56	EC57	EC58	EC59	EC5A	EC5B	EC5C	EC5D	EC5E	EC5F	EC60	EC61	EC62
	Char.		鞞	鞞	鞞	鞞	鞞	鞞	鞞	鞞	鞞	鞞	鞞	鞞	鞞	鞞	鞞
8690	BIG5	EC63	EC64	EC65	EC66	EC67	EC68	EC69	EC6A	EC6B	EC6C	EC6D	EC6E	EC6F	EC70	EC71	EC72
	Char.	駢	駢	駢	駢	駢	駢	駢	駢	駢	駢	駢	駢	駢	駢	駢	駢
86A0	BIG5	EC73	EC74	EC75	EC76	EC77	EC78	EC79	EC7A	EC7B	EC7C	EC7D	EC7E	ECA1	ECA2	ECA3	ECA4
	Char.	鮫	鮫	鮫	鮫	鮫	鮫	鮫	鮫	鮫	鮫	鮫	鮫	鮫	鮫	鮫	鮫
86B0	BIG5	ECA5	ECA6	ECA7	ECA8	ECA9	ECAA	ECAB	ECAC	ECAD	ECAE	ECAF	ECB0	ECB1	ECB2	ECB3	ECB4
	Char.	鴟	鴟	鴟	鴟	鴟	鴟	鴟	鴟	鴟	鴟	鴟	鴟	鴟	鴟	鴟	鴟
86C0	BIG5	ECB5	ECB6	ECB7	ECB8	ECB9	ECBA	ECBB	ECBC	ECBD	ECBE	ECBF	ECC0	ECC1	ECC2	ECC3	ECC4
	Char.	既	既	既	既	既	既	既	既	既	既	既	既	既	既	既	既

Table B-3 IBM à Big5 Conversion Table (continued)

IBM		+ 0	+ 1	+ 2	+ 3	+ 4	+ 5	+ 6	+ 7	+ 8	+ 9	+ A	+ B	+ C	+ D	+ E	+ F
86D0	BIG5	ECC5	ECC6	ECC7	ECC8	ECC9	ECCA	ECCB	ECCC	ECCD	ECCE	ECCF	ECD0	ECD1	ECD2	ECD3	ECD4
	Char.	嚶	嚶	嚶	嚶	嚶	嚶	嚶	嚶	嚶	嫻	嫻	嫻	嫻	嫻	嫻	嫻
86E0	BIG5	ECD5	ECD6	ECD7	ECD8	ECD9	ECDA	ECDB	ECDC	ECDD	ECDE	ECDF	ECE0	ECE1	ECE2	ECE3	ECE4
	Char.	嫻	嫻	嫻	嫻	嫻	嫻	嫻	嫻	嫻	嫻	嫻	嫻	嫻	嫻	嫻	嫻
86F0	BIG5	ECE5	ECE6	ECE7	ECE8	ECE9	ECEA	ECEB	ECEC	ECED	ECEE	ECEF	ECF0	ECF1	ECF2		
	Char.	嫻	嫻	嫻	嫻	嫻	嫻	嫻	嫻	嫻	嫻	嫻	嫻	嫻	嫻		
8740	BIG5		ECF3	ECF4	ECF5	ECF6	ECF7	ECF8	ECF9	ECFA	ECFB	ECFC	ECFD	ECFE	ED40	ED41	ED42
	Char.		嫻	嫻	嫻	嫻	嫻	嫻	嫻	嫻	嫻	嫻	嫻	嫻	嫻	嫻	嫻
8750	BIG5	ED43	ED44	ED45	ED46	ED47	ED48	ED49	ED4A	ED4B	ED4C	ED4D	ED4E	ED4F	ED50	ED51	ED52
	Char.	嫻	嫻	嫻	嫻	嫻	嫻	嫻	嫻	嫻	嫻	嫻	嫻	嫻	嫻	嫻	嫻
8760	BIG5	ED53	ED54	ED55	ED56	ED57	ED58	ED59	ED5A	ED5B	ED5C	ED5D	ED5E	ED5F	ED60	ED61	ED62
	Char.	嫻	嫻	嫻	嫻	嫻	嫻	嫻	嫻	嫻	嫻	嫻	嫻	嫻	嫻	嫻	嫻
8770	BIG5	ED63	ED64	ED65	ED66	ED67	ED68	ED69	ED6A	ED6B	ED6C	ED6D	ED6E	ED6F	ED70	ED71	ED72
	Char.	嫻	嫻	嫻	嫻	嫻	嫻	嫻	嫻	嫻	嫻	嫻	嫻	嫻	嫻	嫻	嫻
8780	BIG5		ED73	ED74	ED75	ED76	ED77	ED78	ED79	ED7A	ED7B	ED7C	ED7D	ED7E	EDA1	EDA2	EDA3
	Char.		嫻	嫻	嫻	嫻	嫻	嫻	嫻	嫻	嫻	嫻	嫻	嫻	嫻	嫻	嫻
8790	BIG5	EDA4	EDA5	EDA6	EDA7	EDA8	EDA9	EDAA	EDAB	EDAC	EDAD	EDAE	EDAF	EDB0	EDB1	EDB2	EDB3
	Char.	嫻	嫻	嫻	嫻	嫻	嫻	嫻	嫻	嫻	嫻	嫻	嫻	嫻	嫻	嫻	嫻
87A0	BIG5	EDB4	EDB5	EDB6	EDB7	EDB8	EDB9	EDBA	EDBB	EDBC	EDBD	EDBE	EDBF	EDC0	EDC1	EDC2	EDC3
	Char.	嫻	嫻	嫻	嫻	嫻	嫻	嫻	嫻	嫻	嫻	嫻	嫻	嫻	嫻	嫻	嫻
87B0	BIG5	EDC4	EDC5	EDC6	EDC7	EDC8	EDC9	EDCA	EDCB	EDCC	EDCD	EDCE	EDCF	EDD0	EDD1	EDD2	EDD3
	Char.	嫻	嫻	嫻	嫻	嫻	嫻	嫻	嫻	嫻	嫻	嫻	嫻	嫻	嫻	嫻	嫻

Table B-3 IBM à Big5 Conversion Table (continued)

IBM		+ 0	+ 1	+ 2	+ 3	+ 4	+ 5	+ 6	+ 7	+ 8	+ 9	+ A	+ B	+ C	+ D	+ E	+ F
87C0	BIG5	EDD4	EDD5	EDD6	EDD7	EDD8	EDD9	EDDA	EDDB	EDDC	EDDD	EDDE	EDDF	EDE0	EDE1	EDE2	EDE3
	Char.	穎	縹	縹	縹	縹	縹	縹	縹	縹	縹	縹	縹	縹	縹	縹	縹
87D0	BIG5	EDE4	EDE5	EDE6	EDE7	EDE8	EDE9	EDEA	EDEB	EDEC	EDED	EDEE	EDEF	EDF0	EDF1	EDF2	EDF3
	Char.	屬	屬	屬	屬	屬	屬	屬	屬	屬	屬	屬	屬	屬	屬	屬	屬
87E0	BIG5	EDF4	EDF5	EDF6	EDF7	EDF8	EDF9	EDFA	EDFB	EDFC	EDFD	EDFE	EE40	EE41	EE42	EE43	EE44
	Char.	蕓	蕓	蕓	蕓	蕓	蕓	蕓	蕓	蕓	蕓	蕓	蕓	蕓	蕓	蕓	蕓
87F0	BIG5	EE45	EE46	EE47	EE48	EE49	EE4A	EE4B	EE4C	EE4D	EE4E	EE4F	EE50	EE51	EE52		
	Char.	蕓	蕓	蕓	蕓	蕓	蕓	蕓	蕓	蕓	蕓	蕓	蕓	蕓	蕓		
8840	BIG5		EE53	EE54	EE55	EE56	EE57	EE58	EE59	EE5A	EE5B	EE5C	EE5D	EE5E	EE5F	EE60	EE61
	Char.		蕓	蕓	蕓	蕓	蕓	蕓	蕓	蕓	蕓	蕓	蕓	蕓	蕓	蕓	蕓
8850	BIG5	EE62	EE63	EE64	EE65	EE66	EE67	EE68	EE69	EE6A	EE6B	EE6C	EE6D	EE6E	EE6F	EE70	EE71
	Char.	蠶	蠶	蠶	蠶	蠶	蠶	蠶	蠶	蠶	蠶	蠶	蠶	蠶	蠶	蠶	蠶
8860	BIG5	EE72	EE73	EE74	EE75	EE76	EE77	EE78	EE79	EE7A	EE7B	EE7C	EE7D	EE7E	EEA1	EEA2	EEA3
	Char.	襪	襪	襪	襪	襪	襪	襪	襪	襪	襪	襪	襪	襪	襪	襪	襪
8870	BIG5	EEA4	EEA5	EEA6	EEA7	EEA8	EEA9	EEAA	EEAB	EEAC	EEAD	EEAE	EEAF	EEB0	EEB1	EEB2	EEB3
	Char.	諺	諺	諺	諺	諺	諺	諺	諺	諺	諺	諺	諺	諺	諺	諺	諺
8880	BIG5		EEB4	EEB5	EEB6	EEB7	EEB8	EEB9	EEBA	EEBB	EEBC	EEBD	EEBE	EEBF	EEC0	EEC1	EEC2
	Char.		獯	獯	獯	獯	獯	獯	獯	獯	獯	獯	獯	獯	獯	獯	獯
8890	BIG5	EEC3	EEC4	EEC5	EEC6	EEC7	EEC8	EEC9	EECA	EECB	EECC	EECD	EECE	EECF	EED0	EED1	EED2
	Char.	遼	遼	遼	遼	遼	遼	遼	遼	遼	遼	遼	遼	遼	遼	遼	遼
88A0	BIG5	EED3	EED4	EED5	EED6	EED7	EED8	EED9	EEDA	EEDB	EEDC	EEDD	EEDE	EEDF	EEE0	EEE1	EEE2
	Char.	鍼	鍼	鍼	鍼	鍼	鍼	鍼	鍼	鍼	鍼	鍼	鍼	鍼	鍼	鍼	鍼
88B0	BIG5	EEE3	EEE4	EEE5	EEE6	EEE7	EEE8	EEE9	EEEA	EEEB	EEEC	EEED	EEEE	EEEF	EEF0	EEF1	EEF2
	Char.	鐮	鐮	鐮	鐮	鐮	鐮	鐮	鐮	鐮	鐮	鐮	鐮	鐮	鐮	鐮	鐮

Table B-3 IBM à Big5 Conversion Table (continued)

IBM		+ 0	+ 1	+ 2	+ 3	+ 4	+ 5	+ 6	+ 7	+ 8	+ 9	+ A	+ B	+ C	+ D	+ E	+ F
88C0	BIG5	EEF3	EEF4	EEF5	EEF6	EEF7	EEF8	EEF9	EEFA	EEFB	EEFC	EEFD	EEFE	EF40	EF41	EF42	EF43
	Char.	綱	隕	隕	隕	露	霏	霏	霏	霏	鞞	鞞	鞞	鞞	鞞	鞞	鞞
88D0	BIG5	EF44	EF45	EF46	EF47	EF48	EF49	EF4A	EF4B	EF4C	EF4D	EF4E	EF4F	EF50	EF51	EF52	EF53
	Char.	鐵	頰	頰	頰	頰	頰	頰	頰	頰	餉	餉	餉	餉	餉	餉	餉
88E0	BIG5	EF54	EF55	EF56	EF57	EF58	EF59	EF5A	EF5B	EF5C	EF5D	EF5E	EF5F	EF60	EF61	EF62	EF63
	Char.	餉	誠	餉	餉	駢	駢	駢	駢	駢	駢	駢	駢	駢	駢	駢	駢
88F0	BIG5	EF64	EF65	EF66	EF67	EF68	EF69	EF6A	EF6B	EF6C	EF6D	EF6E	EF6F	EF70	EF71		
	Char.	餉	鬚	鬚	鬚	鬚	鬚	鬚	鬚	鬚	鮪	鮪	鮪	鮪	鮪		
8940	BIG5		EF72	EF73	EF74	EF75	EF76	EF77	EF78	EF79	EF7A	EF7B	EF7C	EF7D	EF7E	EFA1	EFA2
	Char.		鶯	鶯	鶯	鶯	鶯	鶯	鶯	鶯	鶯	鶯	鶯	鶯	鶯	鶯	鶯
8950	BIG5	EFA3	EFA4	EFA5	EFA6	EFA7	EFA8	EFA9	EFAA	EFAB	EFAC	EFAD	EFAE	EFAF	EFB0	EFB1	EFB2
	Char.	鶯	鶯	鶯	鶯	鶯	鶯	鶯	鶯	鶯	鶯	鶯	鶯	鶯	鶯	鶯	鶯
8960	BIG5	EFB3	EFB4	EFB5	EFB6	EFB7	EFB8	EFB9	EFBA	EFBB	EFBC	EFBD	EFBE	EFBF	EFC0	EFC1	EFC2
	Char.	鶯	鶯	鶯	鶯	鶯	鶯	鶯	鶯	鶯	鶯	鶯	鶯	鶯	鶯	鶯	鶯
8970	BIG5	EFC3	EFC4	EFC5	EFC6	EFC7	EFC8	EFC9	EFCA	EFCB	EFCC	EFCD	EFCE	EFCF	EFD0	EFD1	EFD2
	Char.	鶯	鶯	鶯	鶯	鶯	鶯	鶯	鶯	鶯	鶯	鶯	鶯	鶯	鶯	鶯	鶯
8980	BIG5		EFD3	EFD4	EFD5	EFD6	EFD7	EFD8	EFD9	EFDA	EFDB	EFDC	EFDD	EFDE	EFDF	EFE0	EFE1
	Char.		鶯	鶯	鶯	鶯	鶯	鶯	鶯	鶯	鶯	鶯	鶯	鶯	鶯	鶯	鶯
8990	BIG5	EFE2	EFE3	EFE4	EFE5	EFE6	EFE7	EFE8	EFE9	EFEA	EFEB	EFEC	EFED	EFEF	EFF0	EFF1	
	Char.	鶯	鶯	鶯	鶯	鶯	鶯	鶯	鶯	鶯	鶯	鶯	鶯	鶯	鶯	鶯	
89A0	BIG5	EFF2	EFF3	EFF4	EFF5	EFF6	EFF7	EFF8	EFF9	EFFA	EFFB	EFFC	EFFD	EFEE	F040	F041	F042
	Char.	鶯	鶯	鶯	鶯	鶯	鶯	鶯	鶯	鶯	鶯	鶯	鶯	鶯	鶯	鶯	鶯

Table B-3 IBM à Big5 Conversion Table (continued)

IBM		+ 0	+ 1	+ 2	+ 3	+ 4	+ 5	+ 6	+ 7	+ 8	+ 9	+ A	+ B	+ C	+ D	+ E	+ F
89B0	BIG5	F043	F044	F045	F046	F047	F048	F049	F04A	F04B	F04C	F04D	F04E	F04F	F050	F051	F052
	Char.	瓊	璿	璣	璵	璶	璷	璸	璹	瘡	瘡	瘡	瘡	瘡	瘡	瘡	瘡
89C0	BIG5	F053	F054	F055	F056	F057	F058	F059	F05A	F05B	F05C	F05D	F05E	F05F	F060	F061	F062
	Char.	璽	璿	璠	璡	璢	璣	璤	璥	璦	璨	璩	璪	璫	璬	璭	璮
89D0	BIG5	F063	F064	F065	F066	F067	F068	F069	F06A	F06B	F06C	F06D	F06E	F06F	F070	F071	F072
	Char.	籊	籊	籊	籊	籊	籊	籊	籊	籊	籊	籊	籊	籊	籊	籊	籊
89E0	BIG5	F073	F074	F075	F076	F077	F078	F079	F07A	F07B	F07C	F07D	F07E	FOA1	FOA2	FOA3	FOA4
	Char.	縹	縹	縹	縹	縹	縹	縹	縹	縹	縹	縹	縹	縹	縹	縹	縹
89F0	BIG5	FOA5	FOA6	FOA7	FOA8	FOA9	FOAA	FOAB	FOAC	FOAD	FOAE	FOAF	FOB0	FOB1	FOB2		
	Char.	華	華	華	華	華	華	華	華	華	華	華	華	華	華	華	華
8A40	BIG5		FOB3	FOB4	FOB5	FOB6	FOB7	FOB8	FOB9	FOBA	FOBB	FOBC	FOBD	FOBE	FOBF	FOC0	FOC1
	Char.		藪	藪	藪	藪	藪	藪	藪	藪	藪	藪	藪	藪	藪	藪	藪
8A50	BIG5	FOC2	FOC3	FOC4	FOC5	FOC6	FOC7	FOC8	FOC9	FOCA	FOCB	FOCC	FOCD	FOCE	FOCF	FOD0	FOD1
	Char.	蠟	蠟	蠟	蠟	蠟	蠟	蠟	蠟	蠟	蠟	蠟	蠟	蠟	蠟	蠟	蠟
8A60	BIG5	FOD2	FOD3	FOD4	FOD5	FOD6	FOD7	FOD8	FOD9	FODA	FODB	FODC	FODD	FODE	FODF	FOE0	FOE1
	Char.	禕	禕	禕	禕	禕	禕	禕	禕	禕	禕	禕	禕	禕	禕	禕	禕
8A70	BIG5	FOE2	FOE3	FOE4	FOE5	FOE6	FOE7	FOE8	FOE9	FOEA	FOEB	FOEC	FOED	FOEE	FOEF	FOF0	FOF1
	Char.	諱	諱	諱	諱	諱	諱	諱	諱	諱	諱	諱	諱	諱	諱	諱	諱
8A80	BIG5		FOF2	FOF3	FOF4	FOF5	FOF6	FOF7	FOF8	FOF9	FOFA	FOFB	FOFC	FOFD	FOFE	F140	F141
	Char.		躑	躑	躑	躑	躑	躑	躑	躑	躑	躑	躑	躑	躑	躑	躑
8A90	BIG5	F142	F143	F144	F145	F146	F147	F148	F149	F14A	F14B	F14C	F14D	F14E	F14F	F150	F151
	Char.	躑	躑	躑	躑	躑	躑	躑	躑	躑	躑	躑	躑	躑	躑	躑	躑

Table B-3 IBM à Big5 Conversion Table (continued)

IBM		+ 0	+ 1	+ 2	+ 3	+ 4	+ 5	+ 6	+ 7	+ 8	+ 9	+ A	+ B	+ C	+ D	+ E	+ F
8AA0	BIG5	F152	F153	F154	F155	F156	F157	F158	F159	F15A	F15B	F15C	F15D	F15E	F15F	F160	F161
	Char.	醪	錄	鎌	鐳	鐳	鐳	鐳	鐳	鐳	鐳	鐳	鐳	鐳	鐳	鐳	鐳
8AB0	BIG5	F162	F163	F164	F165	F166	F167	F168	F169	F16A	F16B	F16C	F16D	F16E	F16F	F170	F171
	Char.	錄	錄	錄	錄	錄	錄	錄	錄	錄	錄	錄	錄	錄	錄	錄	錄
8AC0	BIG5	F172	F173	F174	F175	F176	F177	F178	F179	F17A	F17B	F17C	F17D	F17E	F1A1	F1A2	F1A3
	Char.	嶺	嶺	嶺	嶺	嶺	嶺	嶺	嶺	嶺	嶺	嶺	嶺	嶺	嶺	嶺	嶺
8AD0	BIG5	F1A4	F1A5	F1A6	F1A7	F1A8	F1A9	F1AA	F1AB	F1AC	F1AD	F1AE	F1AF	F1B0	F1B1	F1B2	F1B3
	Char.	隄	隄	隄	隄	隄	隄	隄	隄	隄	隄	隄	隄	隄	隄	隄	隄
8AE0	BIG5	F1B4	F1B5	F1B6	F1B7	F1B8	F1B9	F1BA	F1BB	F1BC	F1BD	F1BE	F1BF	F1C0	F1C1	F1C2	F1C3
	Char.	駢	駢	駢	駢	駢	駢	駢	駢	駢	駢	駢	駢	駢	駢	駢	駢
8AF0	BIG5	F1C4	F1C5	F1C6	F1C7	F1C8	F1C9	F1CA	F1CB	F1CC	F1CD	F1CE	F1CF	F1D0	F1D1		
	Char.	舖	舖	舖	舖	舖	舖	舖	舖	舖	舖	舖	舖	舖	舖		
8B40	BIG5		F1D2	F1D3	F1D4	F1D5	F1D6	F1D7	F1D8	F1D9	F1DA	F1DB	F1DC	F1DD	F1DE	F1DF	F1E0
	Char.		鳩	鳩	鳩	鳩	鳩	鳩	鳩	鳩	鳩	鳩	鳩	鳩	鳩	鳩	鳩
8B50	BIG5	F1E1	F1E2	F1E3	F1E4	F1E5	F1E6	F1E7	F1E8	F1E9	F1EA	F1EB	F1EC	F1ED	F1EE	F1EF	F1F0
	Char.	龜	龜	龜	龜	龜	龜	龜	龜	龜	龜	龜	龜	龜	龜	龜	龜
8B60	BIG5	F1F1	F1F2	F1F3	F1F4	F1F5	F1F6	F1F7	F1F8	F1F9	F1FA	F1FB	F1FC	F1FD	F1FE	F240	F241
	Char.	嚙	嚙	嚙	嚙	嚙	嚙	嚙	嚙	嚙	嚙	嚙	嚙	嚙	嚙	嚙	嚙
8B70	BIG5	F242	F243	F244	F245	F246	F247	F248	F249	F24A	F24B	F24C	F24D	F24E	F24F	F250	F251
	Char.	搥	搥	搥	搥	搥	搥	搥	搥	搥	搥	搥	搥	搥	搥	搥	搥
8B80	BIG5		F252	F253	F254	F255	F256	F257	F258	F259	F25A	F25B	F25C	F25D	F25E	F25F	F260
	Char.		櫟	櫟	櫟	櫟	櫟	櫟	櫟	櫟	櫟	櫟	櫟	櫟	櫟	櫟	櫟

Table B-3 IBM à Big5 Conversion Table (continued)

IBM		+ 0	+ 1	+ 2	+ 3	+ 4	+ 5	+ 6	+ 7	+ 8	+ 9	+ A	+ B	+ C	+ D	+ E	+ F
8B90	BIG5	F261	F262	F263	F264	F265	F266	F267	F268	F269	F26A	F26B	F26C	F26D	F26E	F26F	F270
	Char.	瀟	漣	漉	瀕	瀘	瀛	瀝	繁	熿	熿	熿	熿	熿	熿	熿	熿
8BA0	BIG5	F271	F272	F273	F274	F275	F276	F277	F278	F279	F27A	F27B	F27C	F27D	F27E	F2A1	F2A2
	Char.	熿	熿	熿	熿	熿	熿	熿	熿	熿	熿	熿	熿	熿	熿	熿	熿
8BB0	BIG5	F2A3	F2A4	F2A5	F2A6	F2A7	F2A8	F2A9	F2AA	F2AB	F2AC	F2AD	F2AE	F2AF	F2B0	F2B1	F2B2
	Char.	熿	熿	熿	熿	熿	熿	熿	熿	熿	熿	熿	熿	熿	熿	熿	熿
8BC0	BIG5	F2B3	F2B4	F2B5	F2B6	F2B7	F2B8	F2B9	F2BA	F2BB	F2BC	F2BD	F2BE	F2BF	F2C0	F2C1	F2C2
	Char.	熿	熿	熿	熿	熿	熿	熿	熿	熿	熿	熿	熿	熿	熿	熿	熿
8BD0	BIG5	F2C3	F2C4	F2C5	F2C6	F2C7	F2C8	F2C9	F2CA	F2CB	F2CC	F2CD	F2CE	F2CF	F2D0	F2D1	F2D2
	Char.	熿	熿	熿	熿	熿	熿	熿	熿	熿	熿	熿	熿	熿	熿	熿	熿
8BE0	BIG5	F2D3	F2D4	F2D5	F2D6	F2D7	F2D8	F2D9	F2DA	F2DB	F2DC	F2DD	F2DE	F2DF	F2E0	F2E1	F2E2
	Char.	熿	熿	熿	熿	熿	熿	熿	熿	熿	熿	熿	熿	熿	熿	熿	熿
8BF0	BIG5	F2E3	F2E4	F2E5	F2E6	F2E7	F2E8	F2E9	F2EA	F2EB	F2EC	F2ED	F2EE	F2EF	F2F0		
	Char.	熿	熿	熿	熿	熿	熿	熿	熿	熿	熿	熿	熿	熿	熿		
8C40	BIG5		F2F1	F2F2	F2F3	F2F4	F2F5	F2F6	F2F7	F2F8	F2F9	F2FA	F2FB	F2FC	F2FD	F2FE	F340
	Char.		熿	熿	熿	熿	熿	熿	熿	熿	熿	熿	熿	熿	熿	熿	熿
8C50	BIG5	F341	F342	F343	F344	F345	F346	F347	F348	F349	F34A	F34B	F34C	F34D	F34E	F34F	F350
	Char.	熿	熿	熿	熿	熿	熿	熿	熿	熿	熿	熿	熿	熿	熿	熿	熿
8C60	BIG5	F351	F352	F353	F354	F355	F356	F357	F358	F359	F35A	F35B	F35C	F35D	F35E	F35F	F360
	Char.	熿	熿	熿	熿	熿	熿	熿	熿	熿	熿	熿	熿	熿	熿	熿	熿
8C70	BIG5	F361	F362	F363	F364	F365	F366	F367	F368	F369	F36A	F36B	F36C	F36D	F36E	F36F	F370
	Char.	熿	熿	熿	熿	熿	熿	熿	熿	熿	熿	熿	熿	熿	熿	熿	熿

Table B-3 IBM à Big5 Conversion Table (continued)

IBM		+ 0	+ 1	+ 2	+ 3	+ 4	+ 5	+ 6	+ 7	+ 8	+ 9	+ A	+ B	+ C	+ D	+ E	+ F
8C80	BIG5		F371	F372	F373	F374	F375	F376	F377	F378	F379	F37A	F37B	F37C	F37D	F37E	F3A1
	Char.		鑄	鐸	鑪	鑿	鑿	鑿	闌	闌	雞	霏	霏	霏	霏	霏	鞞
8C90	BIG5	F3A2	F3A3	F3A4	F3A5	F3A6	F3A7	F3A8	F3A9	F3AA	F3AB	F3AC	F3AD	F3AE	F3AF	F3B0	F3B1
	Char.	臺	鞞	鞞	鞞	鞞	鞞	鞞	鞞	鞞	鞞	鞞	鞞	鞞	鞞	鞞	鞞
8CA0	BIG5	F3B2	F3B3	F3B4	F3B5	F3B6	F3B7	F3B8	F3B9	F3BA	F3BB	F3BC	F3BD	F3BE	F3BF	F3C0	F3C1
	Char.	馱	馱	馱	馱	馱	馱	馱	馱	馱	馱	馱	馱	馱	馱	馱	馱
8CB0	BIG5	F3C2	F3C3	F3C4	F3C5	F3C6	F3C7	F3C8	F3C9	F3CA	F3CB	F3CC	F3CD	F3CE	F3CF	F3D0	F3D1
	Char.	鬚	鬚	鬚	鬚	鬚	鬚	鬚	鬚	鬚	鬚	鬚	鬚	鬚	鬚	鬚	鬚
8CC0	BIG5	F3D2	F3D3	F3D4	F3D5	F3D6	F3D7	F3D8	F3D9	F3DA	F3DB	F3DC	F3DD	F3DE	F3DF	F3E0	F3E1
	Char.	鯪	鯪	鯪	鯪	鯪	鯪	鯪	鯪	鯪	鯪	鯪	鯪	鯪	鯪	鯪	鯪
8CD0	BIG5	F3E2	F3E3	F3E4	F3E5	F3E6	F3E7	F3E8	F3E9	F3EA	F3EB	F3EC	F3ED	F3EE	F3EF	F3F0	F3F1
	Char.	鷓	鷓	鷓	鷓	鷓	鷓	鷓	鷓	鷓	鷓	鷓	鷓	鷓	鷓	鷓	鷓
8CE0	BIG5	F3F2	F3F3	F3F4	F3F5	F3F6	F3F7	F3F8	F3F9	F3FA	F3FB	F3FC	F3FD	F3FE	F440	F441	F442
	Char.	曆	覽	歷	黼	黼	黼	黼	齋	齋	齋	齋	匱	彈	噯	譽	璣
8CF0	BIG5	F443	F444	F445	F446	F447	F448	F449	F44A	F44B	F44C	F44D	F44E	F44F	F450		
	Char.	熾	嶧	熾	屢	屢	襪	襪	懷	擲	櫻	擲	擲	旗	囈		
8D40	BIG5		F451	F452	F453	F454	F455	F456	F457	F458	F459	F45A	F45B	F45C	F45D	F45E	F45F
	Char.		曠	曠	曠	曠	曠	曠	曠	曠	曠	曠	曠	曠	曠	曠	曠
8D50	BIG5	F460	F461	F462	F463	F464	F465	F466	F467	F468	F469	F46A	F46B	F46C	F46D	F46E	F46F
	Char.	瀾	瀾	瀾	瀾	瀾	瀾	瀾	瀾	瀾	瀾	瀾	瀾	攀	獮	獮	璽
8D60	BIG5	F470	F471	F472	F473	F474	F475	F476	F477	F478	F479	F47A	F47B	F47C	F47D	F47E	F4A1
	Char.	曠	曠	曠	曠	曠	曠	曠	曠	曠	曠	曠	曠	曠	曠	曠	曠

Table B-3 IBM à Big5 Conversion Table (continued)

IBM		+ 0	+ 1	+ 2	+ 3	+ 4	+ 5	+ 6	+ 7	+ 8	+ 9	+ A	+ B	+ C	+ D	+ E	+ F
8D70	BIG5	F4A2	F4A3	F4A4	F4A5	F4A6	F4A7	F4A8	F4A9	F4AA	F4AB	F4AC	F4AD	F4AE	F4AF	F4B0	F4B1
	Char.	穮	穢	穉	穉	穉	穉	穉	穉	穉	穉	穉	穉	穉	穉	穉	穉
8D80	BIG5		F4B2	F4B3	F4B4	F4B5	F4B6	F4B7	F4B8	F4B9	F4BA	F4BB	F4BC	F4BD	F4BE	F4BF	F4C0
	Char.		穉	穉	穉	穉	穉	穉	穉	穉	穉	穉	穉	穉	穉	穉	穉
8D90	BIG5	F4C1	F4C2	F4C3	F4C4	F4C5	F4C6	F4C7	F4C8	F4C9	F4CA	F4CB	F4CC	F4CD	F4CE	F4CF	F4D0
	Char.	穉	穉	穉	穉	穉	穉	穉	穉	穉	穉	穉	穉	穉	穉	穉	穉
8DA0	BIG5	F4D1	F4D2	F4D3	F4D4	F4D5	F4D6	F4D7	F4D8	F4D9	F4DA	F4DB	F4DC	F4DD	F4DE	F4DF	F4E0
	Char.	穉	穉	穉	穉	穉	穉	穉	穉	穉	穉	穉	穉	穉	穉	穉	穉
8DB0	BIG5	F4E1	F4E2	F4E3	F4E4	F4E5	F4E6	F4E7	F4E8	F4E9	F4EA	F4EB	F4EC	F4ED	F4EE	F4EF	F4F0
	Char.	穉	穉	穉	穉	穉	穉	穉	穉	穉	穉	穉	穉	穉	穉	穉	穉
8DC0	BIG5	F4F1	F4F2	F4F3	F4F4	F4F5	F4F6	F4F7	F4F8	F4F9	F4FA	F4FB	F4FC	F4FD	F4FE	F540	F541
	Char.	穉	穉	穉	穉	穉	穉	穉	穉	穉	穉	穉	穉	穉	穉	穉	穉
8DD0	BIG5	F542	F543	F544	F545	F546	F547	F548	F549	F54A	F54B	F54C	F54D	F54E	F54F	F550	F551
	Char.	穉	穉	穉	穉	穉	穉	穉	穉	穉	穉	穉	穉	穉	穉	穉	穉
8DE0	BIG5	F552	F553	F554	F555	F556	F557	F558	F559	F55A	F55B	F55C	F55D	F55E	F55F	F560	F561
	Char.	穉	穉	穉	穉	穉	穉	穉	穉	穉	穉	穉	穉	穉	穉	穉	穉
8DF0	BIG5	F562	F563	F564	F565	F566	F567	F568	F569	F56A	F56B	F56C	F56D	F56E	F56F		
	Char.	穉	穉	穉	穉	穉	穉	穉	穉	穉	穉	穉	穉	穉	穉		
8E40	BIG5		F570	F571	F572	F573	F574	F575	F576	F577	F578	F579	F57A	F57B	F57C	F57D	F57E
	Char.		穉	穉	穉	穉	穉	穉	穉	穉	穉	穉	穉	穉	穉	穉	穉
8E50	BIG5	F5A1	F5A2	F5A3	F5A4	F5A5	F5A6	F5A7	F5A8	F5A9	F5AA	F5AB	F5AC	F5AD	F5AE	F5AF	F5B0
	Char.	穉	穉	穉	穉	穉	穉	穉	穉	穉	穉	穉	穉	穉	穉	穉	穉

Table B-3 IBM à Big5 Conversion Table (continued)

IBM		+ 0	+ 1	+ 2	+ 3	+ 4	+ 5	+ 6	+ 7	+ 8	+ 9	+ A	+ B	+ C	+ D	+ E	+ F
8E60	BIG5	F5B1	F5B2	F5B3	F5B4	F5B5	F5B6	F5B7	F5B8	F5B9	F5BA	F5BB	F5BC	F5BD	F5BE	F5BF	F5C0
	Char.	麤	麤	麤	黠	黠	黠	黠	颯	颯	颯	齧	齧	齧	齧	龔	龔
8E70	BIG5	F5C1	F5C2	F5C3	F5C4	F5C5	F5C6	F5C7	F5C8	F5C9	F5CA	F5CB	F5CC	F5CD	F5CE	F5CF	F5D0
	Char.	債	劓	劓	嘸	嘖	嘖	媼	媼	媼	媼	媼	媼	媼	媼	媼	媼
8E80	BIG5		F5D1	F5D2	F5D3	F5D4	F5D5	F5D6	F5D7	F5D8	F5D9	F5DA	F5DB	F5DC	F5DD	F5DE	F5DF
	Char.		榑	榑	灑	灑	灑	灑	灑	灑	灑	灑	灑	灑	灑	灑	灑
8E90	BIG5	F5E0	F5E1	F5E2	F5E3	F5E4	F5E5	F5E6	F5E7	F5E8	F5E9	F5EA	F5EB	F5EC	F5ED	F5EE	F5EF
	Char.	矚	矚	矚	矚	矚	矚	矚	矚	矚	矚	矚	矚	矚	矚	矚	矚
8EA0	BIG5	F5F0	F5F1	F5F2	F5F3	F5F4	F5F5	F5F6	F5F7	F5F8	F5F9	F5FA	F5FB	F5FC	F5FD	F5FE	F640
	Char.	羸	羸	羸	羸	羸	羸	羸	羸	羸	羸	羸	羸	羸	羸	羸	羸
8EBO	BIG5	F641	F642	F643	F644	F645	F646	F647	F648	F649	F64A	F64B	F64C	F64D	F64E	F64F	F650
	Char.	蠅	蠅	蠅	蠅	蠅	蠅	蠅	蠅	蠅	蠅	蠅	蠅	蠅	蠅	蠅	蠅
8ECO	BIG5	F651	F652	F653	F654	F655	F656	F657	F658	F659	F65A	F65B	F65C	F65D	F65E	F65F	F660
	Char.	譽	臚	臚	臚	臚	臚	臚	臚	臚	臚	臚	臚	臚	臚	臚	臚
8EDO	BIG5	F661	F662	F663	F664	F665	F666	F667	F668	F669	F66A	F66B	F66C	F66D	F66E	F66F	F670
	Char.	鑊	鑊	鑊	鑊	鑊	鑊	鑊	鑊	鑊	鑊	鑊	鑊	鑊	鑊	鑊	鑊
8EE0	BIG5	F671	F672	F673	F674	F675	F676	F677	F678	F679	F67A	F67B	F67C	F67D	F67E	F6A1	F6A2
	Char.	鞞	鞞	鞞	鞞	鞞	鞞	鞞	鞞	鞞	鞞	鞞	鞞	鞞	鞞	鞞	鞞
8EF0	BIG5	F6A3	F6A4	F6A5	F6A6	F6A7	F6A8	F6A9	F6AA	F6AB	F6AC	F6AD	F6AE	F6AF	F6B0		
	Char.	鬚	鬚	鬚	鬚	鬚	鬚	鬚	鬚	鬚	鬚	鬚	鬚	鬚	鬚		
8F40	BIG5		F6B1	F6B2	F6B3	F6B4	F6B5	F6B6	F6B7	F6B8	F6B9	F6BA	F6BB	F6BC	F6BD	F6BE	F6BF
	Char.		鰓	鰓	鰓	鰓	鰓	鰓	鰓	鰓	鰓	鰓	鰓	鰓	鰓	鰓	鰓

Table B-3 IBM à Big5 Conversion Table (continued)

IBM		+ 0	+ 1	+ 2	+ 3	+ 4	+ 5	+ 6	+ 7	+ 8	+ 9	+ A	+ B	+ C	+ D	+ E	+ F
8F50	BIG5	F6C0	F6C1	F6C2	F6C3	F6C4	F6C5	F6C6	F6C7	F6C8	F6C9	F6CA	F6CB	F6CC	F6CD	F6CE	F6CF
	Char.	鵠	鶻	鵠	鶻	鶻	鶻	鶻	鶻	鶻	鶻	鶻	鶻	鶻	鶻	鶻	鶻
8F60	BIG5	F6D0	F6D1	F6D2	F6D3	F6D4	F6D5	F6D6	F6D7	F6D8	F6D9	F6DA	F6DB	F6DC	F6DD	F6DE	F6DF
	Char.	鶻	鶻	鶻	鶻	鶻	鶻	鶻	鶻	鶻	鶻	鶻	鶻	鶻	鶻	鶻	鶻
8F70	BIG5	F6E0	F6E1	F6E2	F6E3	F6E4	F6E5	F6E6	F6E7	F6E8	F6E9	F6EA	F6EB	F6EC	F6ED	F6EE	F6EF
	Char.	鶻	鶻	鶻	鶻	鶻	鶻	鶻	鶻	鶻	鶻	鶻	鶻	鶻	鶻	鶻	鶻
8F80	BIG5		F6F0	F6F1	F6F2	F6F3	F6F4	F6F5	F6F6	F6F7	F6F8	F6F9	F6FA	F6FB	F6FC	F6FD	F6FE
	Char.		鶻	鶻	鶻	鶻	鶻	鶻	鶻	鶻	鶻	鶻	鶻	鶻	鶻	鶻	鶻
8F90	BIG5	F740	F741	F742	F743	F744	F745	F746	F747	F748	F749	F74A	F74B	F74C	F74D	F74E	F74F
	Char.	鶻	鶻	鶻	鶻	鶻	鶻	鶻	鶻	鶻	鶻	鶻	鶻	鶻	鶻	鶻	鶻
8FA0	BIG5	F750	F751	F752	F753	F754	F755	F756	F757	F758	F759	F75A	F75B	F75C	F75D	F75E	F75F
	Char.	鶻	鶻	鶻	鶻	鶻	鶻	鶻	鶻	鶻	鶻	鶻	鶻	鶻	鶻	鶻	鶻
8FB0	BIG5	F760	F761	F762	F763	F764	F765	F766	F767	F768	F769	F76A	F76B	F76C	F76D	F76E	F76F
	Char.	鶻	鶻	鶻	鶻	鶻	鶻	鶻	鶻	鶻	鶻	鶻	鶻	鶻	鶻	鶻	鶻
8FC0	BIG5	F770	F771	F772	F773	F774	F775	F776	F777	F778	F779	F77A	F77B	F77C	F77D	F77E	F7A1
	Char.	鶻	鶻	鶻	鶻	鶻	鶻	鶻	鶻	鶻	鶻	鶻	鶻	鶻	鶻	鶻	鶻
8FD0	BIG5	F7A2	F7A3	F7A4	F7A5	F7A6	F7A7	F7A8	F7A9	F7AA	F7AB	F7AC	F7AD	F7AE	F7AF	F7B0	F7B1
	Char.	鶻	鶻	鶻	鶻	鶻	鶻	鶻	鶻	鶻	鶻	鶻	鶻	鶻	鶻	鶻	鶻
8FE0	BIG5	F7B2	F7B3	F7B4	F7B5	F7B6	F7B7	F7B8	F7B9	F7BA	F7BB	F7BC	F7BD	F7BE	F7BF	F7C0	F7C1
	Char.	鶻	鶻	鶻	鶻	鶻	鶻	鶻	鶻	鶻	鶻	鶻	鶻	鶻	鶻	鶻	鶻
8FF0	BIG5	F7C2	F7C3	F7C4	F7C5	F7C6	F7C7	F7C8	F7C9	F7CA	F7CB	F7CC	F7CD	F7CE	F7CF		
	Char.	鶻	鶻	鶻	鶻	鶻	鶻	鶻	鶻	鶻	鶻	鶻	鶻	鶻	鶻		

Table B-3 IBM à Big5 Conversion Table (continued)

IBM		+ 0	+ 1	+ 2	+ 3	+ 4	+ 5	+ 6	+ 7	+ 8	+ 9	+ A	+ B	+ C	+ D	+ E	+ F
9040	BIG5		F7D0	F7D1	F7D2	F7D3	F7D4	F7D5	F7D6	F7D7	F7D8	F7D9	F7DA	F7DB	F7DC	F7DD	F7DE
	Char.		儻	劓	豐	礫	穉	嫩	嶽	廩	覆	懋	懽	懽	攢	攢	臺
9050	BIG5	F7DF	F7E0	F7E1	F7E2	F7E3	F7E4	F7E5	F7E6	F7E7	F7E8	F7E9	F7EA	F7EB	F7EC	F7ED	F7EE
	Char.	譽	攢	樂	權	鬻	澗	澗	廩	衛	穢	穢	癡	癡	籊	籊	縑
9060	BIG5	F7EF	F7F0	F7F1	F7F2	F7F3	F7F4	F7F5	F7F6	F7F7	F7F8	F7F9	F7FA	F7FB	F7FC	F7FD	F7FE
	Char.	艘	離	壘	穢	菲	頰	繫	瓊	蠟	錫	蠟	蠟	襪	襪	襪	鯨
9070	BIG5	F840	F841	F842	F843	F844	F845	F846	F847	F848	F849	F84A	F84B	F84C	F84D	F84E	F84F
	Char.	讖	讖	讖	讖	讖	讖	讖	讖	讖	讖	讖	讖	讖	讖	讖	讖
9080	BIG5		F850	F851	F852	F853	F854	F855	F856	F857	F858	F859	F85A	F85B	F85C	F85D	F85E
	Char.		鞞	護	職	鹽	震	鬻	鬻	鯨	鯨	鯨	鯨	鯨	鯨	鯨	鯨
9090	BIG5	F85F	F860	F861	F862	F863	F864	F865	F866	F867	F868	F869	F86A	F86B	F86C	F86D	F86E
	Char.	鯨	鯨	鯨	鯨	鯨	鯨	鯨	鯨	鯨	鯨	鯨	鯨	鯨	鯨	鯨	鯨
90A0	BIG5	F86F	F870	F871	F872	F873	F874	F875	F876	F877	F878	F879	F87A	F87B	F87C	F87D	F87E
	Char.	鵠	鵠	鵠	鵠	鵠	鵠	鵠	鵠	鵠	鵠	鵠	鵠	鵠	鵠	鵠	鵠
90B0	BIG5	F8A1	F8A2	F8A3	F8A4	F8A5	F8A6	F8A7	F8A8	F8A9	F8AA	F8AB	F8AC	F8AD	F8AE	F8AF	F8B0
	Char.	齷	齷	齷	齷	齷	齷	齷	齷	齷	齷	齷	齷	齷	齷	齷	齷
90C0	BIG5	F8B1	F8B2	F8B3	F8B4	F8B5	F8B6	F8B7	F8B8	F8B9	F8BA	F8BB	F8BC	F8BD	F8BE	F8BF	F8C0
	Char.	燻	燻	燻	燻	燻	燻	燻	燻	燻	燻	燻	燻	燻	燻	燻	燻
90D0	BIG5	F8C1	F8C2	F8C3	F8C4	F8C5	F8C6	F8C7	F8C8	F8C9	F8CA	F8CB	F8CC	F8CD	F8CE	F8CF	F8D0
	Char.	讖	讖	讖	讖	讖	讖	讖	讖	讖	讖	讖	讖	讖	讖	讖	讖
90E0	BIG5	F8D1	F8D2	F8D3	F8D4	F8D5	F8D6	F8D7	F8D8	F8D9	F8DA	F8DB	F8DC	F8DD	F8DE	F8DF	F8E0
	Char.	鬻	鬻	鬻	鬻	鬻	鬻	鬻	鬻	鬻	鬻	鬻	鬻	鬻	鬻	鬻	鬻

Table B-3 IBM à Big5 Conversion Table (continued)

IBM		+ 0	+ 1	+ 2	+ 3	+ 4	+ 5	+ 6	+ 7	+ 8	+ 9	+ A	+ B	+ C	+ D	+ E	+ F
90F0	BIG5	F8E1	F8E2	F8E3	F8E4	F8E5	F8E6	F8E7	F8E8	F8E9	F8EA	F8EB	F8EC	F8ED	F8EE		
	Char.	鸚	鸚	羸	鸞	鸞	鸞	鸞	鷹	鷹	鷹	鷹	鷹	鷹	鷹		
9140	BIG5		F8EF	F8F0	F8F1	F8F2	F8F3	F8F4	F8F5	F8F6	F8F7	F8F8	F8F9	F8FA	F8FB	F8FC	F8FD
	Char.		接	斲	標	標	標	標	標	標	標	標	標	標	標	標	標
9150	BIG5	F8FE	F940	F941	F942	F943	F944	F945	F946	F947	F948	F949	F94A	F94B	F94C	F94D	F94E
	Char.	繩	纜	纜	纜	纜	纜	纜	纜	纜	纜	纜	纜	纜	纜	纜	纜
9160	BIG5	F94F	F950	F951	F952	F953	F954	F955	F956	F957	F958	F959	F95A	F95B	F95C	F95D	F95E
	Char.	躡	躡	躡	鑄	鑄	鑄	鑄	鑄	鑄	鑄	鑄	鑄	鑄	鑄	鑄	鑄
9170	BIG5	F95F	F960	F961	F962	F963	F964	F965	F966	F967	F968	F969	F96A	F96B	F96C	F96D	F96E
	Char.	鶴	鶴	鸞	鸞	鸞	鸞	鸞	鸞	鸞	鸞	鸞	鸞	鸞	鸞	鸞	鸞
9180	BIG5		F96F	F970	F971	F972	F973	F974	F975	F976	F977	F978	F979	F97A	F97B	F97C	F97D
	Char.		趙	躡	鑄	鑄	鑄	鑄	鑄	鑄	鑄	鑄	鑄	鑄	鑄	鑄	鑄
9190	BIG5	F97E	F9A1	F9A2	F9A3	F9A4	F9A5	F9A6	F9A7	F9A8	F9A9	F9AA	F9AB	F9AC	F9AD	F9AE	F9AF
	Char.	龜	龜	龜	龜	龜	龜	龜	龜	龜	龜	龜	龜	龜	龜	龜	龜
91A0	BIG5	F9B0	F9B1	F9B2	F9B3	F9B4	F9B5	F9B6	F9B7	F9B8	F9B9	F9BA	F9BB	F9BC	F9BD	F9BE	F9BF
	Char.	觀	饋	轟	驥	驥	驥	驥	驥	驥	驥	驥	驥	驥	驥	驥	驥
91B0	BIG5	F9C0	F9C1	F9C2	F9C3	F9C4	F9C5	F9C6	F9C7	F9C8	F9C9	F9CA	F9CB	F9CC	F9CD	F9CE	F9CF
	Char.	鐵	鐵	鐵	鐵	鐵	鐵	鐵	鐵	鐵	鐵	鐵	鐵	鐵	鐵	鐵	鐵
91C0	BIG5	F9D0	F9D1	F9D2	F9D3	F9D4	F9D5	FFFF	FFFF	FFFF	FFFF	FFFF	FFFF	FFFF	FFFF	FFFF	FFFF
	Char.	盡	滯	盡	盡	盡	盡										
91D0	BIG5	FFFF	FFFF	FFFF	FFFF	FFFF	FFFF	FFFF	FFFF	FFFF	FFFF	FFFF	FFFF	FFFF	FFFF	FFFF	FFFF
	Char.																

Table B-3 IBM à Big5 Conversion Table (continued)

IBM		+ 0	+ 1	+ 2	+ 3	+ 4	+ 5	+ 6	+ 7	+ 8	+ 9	+ A	+ B	+ C	+ D	+ E	+ F
91E0	BIG5	FFFF	FFFF	FFFF	FFFF	FFFF	FFFF	FFFF	FFFF	FFFF	FFFF	FFFF	FFFF	FFFF	FFFF	FFFF	FFFF
	Char.																
91F0	BIG5	FFFF	FFFF	FFFF	FFFF	FFFF	FFFF	FFFF	FFFF	FFFF	FFFF	FFFF	FFFF	FFFF	FFFF		
	Char.																
C240	BIG5		FFFF	FFFF	FFFF	FFFF	FFFF	FFFF	FFFF	FFFF	FFFF	FFFF	FFFF	FFFF	FFFF	FFFF	FFFF
	Char.																
C250	BIG5	FFFF	FFFF	FFFF	FFFF	FFFF	FFFF	FFFF	FFFF	FFFF	FFFF	FFFF	FFFF	FFFF	FFFF	FFFF	FFFF
	Char.																
C260	BIG5	FFFF	FFFF	FFFF	FFFF	FFFF	FFFF	FFFF	FFFF	FFFF	FFFF	FFFF	FFFF	FFFF	FFFF	FFFF	FFFF
	Char.																
C270	BIG5	FFFF	FFFF	FFFF	FFFF	FFFF	FFFF	FFFF	FFFF	FFFF	FFFF	FFFF	FFFF	FFFF	FFFF	FFFF	FFFF
	Char.																
C280	BIG5		FFFF	FFFF	FFFF	FFFF	FFFF	FFFF	FFFF	FFFF	FFFF	FFFF	FFFF	FFFF	FFFF	FFFF	FFFF
	Char.																
C290	BIG5	FFFF	FFFF	FFFF	FFFF	FFFF	FFFF	FFFF	FFFF	FFFF	FFFF	FFFF	FFFF	FFFF	FFFF	FFFF	FFFF
	Char.																
C2A0	BIG5	FFFF	FFFF	FFFF	FFFF	FFFF	FFFF	FFFF	FFFF	FFFF	FFFF	FFFF	FFFF	FFFF	FFFF	FFFF	FFFF
	Char.																
C2B0	BIG5	FFFF	FFFF	FFFF	FFFF	FFFF	FFFF	FFFF	FFFF	FFFF	FFFF	FFFF	FFFF	FFFF	FFFF	FFFF	FFFF
	Char.																
C2C0	BIG5	FFFF	FFFF	FFFF	FFFF	FFFF	FFFF	FFFF	FFFF	FFFF	FFFF	FFFF	FFFF	FFFF	FFFF	FFFF	FFFF
	Char.																
C2D0	BIG5	FFFF	FFFF	FFFF	FFFF	FFFF	FFFF	FFFF	FFFF	FFFF	FFFF	FFFF	FFFF	FFFF	FFFF	FFFF	FFFF
	Char.																

Table B-3 IBM à Big5 Conversion Table (continued)

IBM		+ 0	+ 1	+ 2	+ 3	+ 4	+ 5	+ 6	+ 7	+ 8	+ 9	+ A	+ B	+ C	+ D	+ E	+ F
C2E0	BIG5	FFFF	FFFF	FFFF	FFFF	FFFF	FFFF	FFFF	FFFF	FFFF	FFFF	FFFF	FFFF	FFFF	FFFF	FFFF	FFFF
	Char.																
C2F0	BIG5	FFFF	FFFF	FFFF	FFFF	FFFF	FFFF	FFFF	FFFF	FFFF	FFFF	FFFF	FFFF	FFFF	FFFF		
	Char.																
C340	BIG5		FFFF	FFFF	FFFF	FFFF	FFFF	FFFF	FFFF	FFFF	FFFF	FFFF	FFFF	FFFF	FFFF	FFFF	FFFF
	Char.																
C350	BIG5	FFFF	FFFF	FFFF	FFFF	FFFF	FFFF	FFFF	FFFF	FFFF	FFFF	FFFF	FFFF	FFFF	FFFF	FFFF	FFFF
	Char.																
C360	BIG5	FFFF	FFFF	FFFF	FFFF	FFFF	FFFF	FFFF	FFFF	FFFF	FFFF	FFFF	FFFF	FFFF	FFFF	FFFF	FFFF
	Char.																
C370	BIG5	FFFF	FFFF	FFFF	FFFF	FFFF	FFFF	FFFF	FFFF	FFFF	FFFF	FFFF	FFFF	FFFF	FFFF	FFFF	FFFF
	Char.																
C380	BIG5		FFFF	FFFF	FFFF	FFFF	FFFF	FFFF	FFFF	FFFF	FFFF	FFFF	FFFF	FFFF	FFFF	FFFF	FFFF
	Char.																
C390	BIG5	FFFF	FFFF	FFFF	FFFF	FFFF	FFFF	FFFF	FFFF	FFFF	FFFF	FFFF	FFFF	FFFF	FFFF	FFFF	FFFF
	Char.																
C3A0	BIG5	FFFF	FFFF	FFFF	FFFF	FFFF	FFFF	FFFF	FFFF	FFFF	FFFF	FFFF	FFFF	FFFF	FFFF	FFFF	FFFF
	Char.																
C3B0	BIG5	FFFF	FFFF	FFFF	FFFF	FFFF	FFFF	FFFF	FFFF	FFFF	FFFF	FFFF	FFFF	FFFF	FFFF	FFFF	FFFF
	Char.																
C3C0	BIG5	FFFF	FFFF	FFFF	FFFF	FFFF	FFFF	FFFF	FFFF	FFFF	FFFF	FFFF	FFFF	FFFF	FFFF	FFFF	FFFF
	Char.																
C3D0	BIG5	FFFF	FFFF	FFFF	FFFF	FFFF	FFFF	FFFF	FFFF	FFFF	FFFF	FFFF	FFFF	FFFF	FFFF	FFFF	FFFF
	Char.																

Table B-3 IBM à Big5 Conversion Table (continued)

IBM		+ 0	+ 1	+ 2	+ 3	+ 4	+ 5	+ 6	+ 7	+ 8	+ 9	+ A	+ B	+ C	+ D	+ E	+ F
C3E0	BIG5	FFFF	FFFF	FFFF	FFFF	FFFF	FFFF	FFFF	FFFF	FFFF	FFFF	FFFF	FFFF	FFFF	FFFF	FFFF	FFFF
	Char.																
C3F0	BIG5	FFFF	FFFF	FFFF	FFFF	FFFF	FFFF	FFFF	FFFF	FFFF	FFFF	FFFF	FFFF	FFFF	FFFF		
	Char.																
C440	BIG5		FFFF	FFFF	FFFF	FFFF	FFFF	FFFF	FFFF	FFFF	FFFF	FFFF	FFFF	FFFF	FFFF	FFFF	FFFF
	Char.																
C450	BIG5	FFFF	FFFF	FFFF	FFFF	FFFF	FFFF	FFFF	FFFF	FFFF	FFFF	FFFF	FFFF	FFFF	FFFF	FFFF	FFFF
	Char.																
C460	BIG5	FFFF	FFFF	FFFF	FFFF	FFFF	FFFF	FFFF	FFFF	FFFF	FFFF	FFFF	FFFF	FFFF	FFFF	FFFF	FFFF
	Char.																
C470	BIG5	FFFF	FFFF	FFFF	FFFF	FFFF	FFFF	FFFF	FFFF	FFFF	FFFF	FFFF	FFFF	FFFF	FFFF	FFFF	FFFF
	Char.																
C480	BIG5		FFFF	FFFF	FFFF	FFFF	FFFF	FFFF	FFFF	FFFF	FFFF	FFFF	FFFF	FFFF	FFFF	FFFF	FFFF
	Char.																
C490	BIG5	FFFF	FFFF	FFFF	FFFF	FFFF	FFFF	FFFF	FFFF	FFFF	FFFF	FFFF	FFFF	FFFF	FFFF	FFFF	FFFF
	Char.																
C4A0	BIG5	FFFF	FFFF	FFFF	FFFF	FFFF	FFFF	FFFF	FFFF	FFFF	FFFF	FFFF	FFFF	FFFF	FFFF	FFFF	FFFF
	Char.																
C4B0	BIG5	FFFF	FFFF	FFFF	FFFF	FFFF	FFFF	FFFF	FFFF	FFFF	FFFF	FFFF	FFFF	FFFF	FFFF	FFFF	FFFF
	Char.																
C4C0	BIG5	FFFF	FFFF	FFFF	FFFF	FFFF	FFFF	FFFF	FFFF	FFFF	FFFF	FFFF	FFFF	FFFF	FFFF	FFFF	FFFF
	Char.																
C4D0	BIG5	FFFF	FFFF	FFFF	FFFF	FFFF	FFFF	FFFF	FFFF	FFFF	FFFF	FFFF	FFFF	FFFF	FFFF	FFFF	FFFF
	Char.																

Table B-3 IBM à Big5 Conversion Table (continued)

IBM		+ 0	+ 1	+ 2	+ 3	+ 4	+ 5	+ 6	+ 7	+ 8	+ 9	+ A	+ B	+ C	+ D	+ E	+ F
C4E0	BIG5	FFFF	FFFF	FFFF	FFFF	FFFF	FFFF	FFFF	FFFF	FFFF	FFFF	FFFF	FFFF	FFFF	FFFF	FFFF	FFFF
	Char.																
C4F0	BIG5	FFFF	FFFF	FFFF	FFFF	FFFF	FFFF	FFFF	FFFF	FFFF	FFFF	FFFF	FFFF	FFFF	FFFF		
	Char.																
C540	BIG5		FFFF	FFFF	FFFF	FFFF	FFFF	FFFF	FFFF	FFFF	FFFF	FFFF	FFFF	FFFF	FFFF	FFFF	FFFF
	Char.																
C550	BIG5	FFFF	FFFF	FFFF	FFFF	FFFF	FFFF	FFFF	FFFF	FFFF	FFFF	FFFF	FFFF	FFFF	FFFF	FFFF	FFFF
	Char.																
C560	BIG5	FFFF	FFFF	FFFF	FFFF	FFFF	FFFF	FFFF	FFFF	FFFF	FFFF	FFFF	FFFF	FFFF	FFFF	FFFF	FFFF
	Char.																
C570	BIG5	FFFF	FFFF	FFFF	FFFF	FFFF	FFFF	FFFF	FFFF	FFFF	FFFF	FFFF	FFFF	FFFF	FFFF	FFFF	FFFF
	Char.																
C580	BIG5		FFFF	FFFF	FFFF	FFFF	FFFF	FFFF	FFFF	FFFF	FFFF	FFFF	FFFF	FFFF	FFFF	FFFF	FFFF
	Char.																
C590	BIG5	FFFF	FFFF	FFFF	FFFF	FFFF	FFFF	FFFF	FFFF	FFFF	FFFF	FFFF	FFFF	FFFF	FFFF	FFFF	FFFF
	Char.																
C5A0	BIG5	FFFF	FFFF	FFFF	FFFF	FFFF	FFFF	FFFF	FFFF	FFFF	FFFF	FFFF	FFFF	FFFF	FFFF	FFFF	FFFF
	Char.																
C5B0	BIG5	FFFF	FFFF	FFFF	FFFF	FFFF	FFFF	FFFF	FFFF	FFFF	FFFF	FFFF	FFFF	FFFF	FFFF	FFFF	FFFF
	Char.																
C5C0	BIG5	FFFF	FFFF	FFFF	FFFF	FFFF	FFFF	FFFF	FFFF	FFFF	FFFF	FFFF	FFFF	FFFF	FFFF	FFFF	FFFF
	Char.																
C5D0	BIG5	FFFF	FFFF	FFFF	FFFF	FFFF	FFFF	FFFF	FFFF	FFFF	FFFF	FFFF	FFFF	FFFF	FFFF	FFFF	FFFF
	Char.																

Table B-3 IBM à Big5 Conversion Table (continued)

IBM		+ 0	+ 1	+ 2	+ 3	+ 4	+ 5	+ 6	+ 7	+ 8	+ 9	+ A	+ B	+ C	+ D	+ E	+ F
C5E0	BIG5	FFFF	FFFF	FFFF	FFFF	FFFF	FFFF	FFFF	FFFF	FFFF	FFFF	FFFF	FFFF	FFFF	FFFF	FFFF	FFFF
	Char.																
C5F0	BIG5	FFFF	FFFF	FFFF	FFFF	FFFF	FFFF	FFFF	FFFF	FFFF	FFFF	FFFF	FFFF	FFFF	FFFF		
	Char.																
C640	BIG5		FFFF	FFFF	FFFF	FFFF	FFFF	FFFF	FFFF	FFFF	FFFF	FFFF	FFFF	FFFF	FFFF	FFFF	FFFF
	Char.																
C650	BIG5	FFFF	FFFF	FFFF	FFFF	FFFF	FFFF	FFFF	FFFF	FFFF	FFFF	FFFF	FFFF	FFFF	FFFF	FFFF	FFFF
	Char.																
C660	BIG5	FFFF	FFFF	FFFF	FFFF	FFFF	FFFF	FFFF	FFFF	FFFF	FFFF	FFFF	FFFF	FFFF	FFFF	FFFF	FFFF
	Char.																
C670	BIG5	FFFF	FFFF	FFFF	FFFF	FFFF	FFFF	FFFF	FFFF	FFFF	FFFF	FFFF	FFFF	FFFF	FFFF	FFFF	FFFF
	Char.																
C680	BIG5		FFFF	FFFF	FFFF	FFFF	FFFF	FFFF	FFFF	FFFF	FFFF	FFFF	FFFF	FFFF	FFFF	FFFF	FFFF
	Char.																
C690	BIG5	FFFF	FFFF	FFFF	FFFF	FFFF	FFFF	FFFF	FFFF	FFFF	FFFF	FFFF	FFFF	FFFF	FFFF	FFFF	FFFF
	Char.																
C6A0	BIG5	FFFF	FFFF	FFFF	FFFF	FFFF	FFFF	FFFF	FFFF	FFFF	FFFF	FFFF	FFFF	FFFF	FFFF	FFFF	FFFF
	Char.																
C6B0	BIG5	FFFF	FFFF	FFFF	FFFF	FFFF	FFFF	FFFF	FFFF	FFFF	FFFF	FFFF	FFFF	FFFF	FFFF	FFFF	FFFF
	Char.																
C6C0	BIG5	FFFF	FFFF	FFFF	FFFF	FFFF	FFFF	FFFF	FFFF	FFFF	FFFF	FFFF	FFFF	FFFF	FFFF	FFFF	FFFF
	Char.																

Table B-3 IBM à Big5 Conversion Table (continued)

IBM		+ 0	+ 1	+ 2	+ 3	+ 4	+ 5	+ 6	+ 7	+ 8	+ 9	+ A	+ B	+ C	+ D	+ E	+ F
C6D0	BIG5	FFFF	FFFF	FFFF	FFFF	FFFF	FFFF	FFFF	FFFF	FFFF	FFFF	FFFF	FFFF	FFFF	FFFF	FFFF	FFFF
	Char.																
C6E0	BIG5	FFFF	FFFF	FFFF	FFFF	FFFF	FFFF	FFFF	FFFF	FFFF	FFFF	FFFF	FFFF	FFFF	FFFF	FFFF	FFFF
	Char.																
C6F0	BIG5	FFFF	FFFF	FFFF	FFFF	FFFF	FFFF	FFFF	FFFF	FFFF	FFFF	FFFF	FFFF	FFFF	FFFF		
	Char.																
C740	BIG5		FFFF	FFFF	FFFF	FFFF	FFFF	FFFF	FFFF	FFFF	FFFF	FFFF	FFFF	FFFF	FFFF	FFFF	FFFF
	Char.																
C750	BIG5	FFFF	FFFF	FFFF	FFFF	FFFF	FFFF	FFFF	FFFF	FFFF	FFFF	FFFF	FFFF	FFFF	FFFF	FFFF	FFFF
	Char.																
C760	BIG5	FFFF	FFFF	FFFF	FFFF	FFFF	FFFF	FFFF	FFFF	FFFF	FFFF	FFFF	FFFF	FFFF	FFFF	FFFF	FFFF
	Char.																
C770	BIG5	FFFF	FFFF	FFFF	FFFF	FFFF	FFFF	FFFF	FFFF	FFFF	FFFF	FFFF	FFFF	FFFF	FFFF	FFFF	FFFF
	Char.																
C780	BIG5		FFFF	FFFF	FFFF	FFFF	FFFF	FFFF	FFFF	FFFF	FFFF	FFFF	FFFF	FFFF	FFFF	FFFF	FFFF
	Char.																
C790	BIG5	FFFF	FFFF	FFFF	FFFF	FFFF	FFFF	FFFF	FFFF	FFFF	FFFF	FFFF	FFFF	FFFF	FFFF	FFFF	FFFF
	Char.																
C7A0	BIG5	FFFF	FFFF	FFFF	FFFF	FFFF	FFFF	FFFF	FFFF	FFFF	FFFF	FFFF	FFFF	FFFF	FFFF	FFFF	FFFF
	Char.																
C7B0	BIG5	FFFF	FFFF	FFFF	FFFF	FFFF	FFFF	FFFF	FFFF	FFFF	FFFF	FFFF	FFFF	FFFF	FFFF	FFFF	FFFF
	Char.																

Table B-3 IBM à Big5 Conversion Table (continued)

IBM		+ 0	+ 1	+ 2	+ 3	+ 4	+ 5	+ 6	+ 7	+ 8	+ 9	+ A	+ B	+ C	+ D	+ E	+ F
C7C0	BIG5	FFFF	FFFF	FFFF	FFFF	FFFF	FFFF	FFFF	FFFF	FFFF	FFFF	FFFF	FFFF	FFFF	FFFF	FFFF	FFFF
	Char.																
C7D0	BIG5	FFFF	FFFF	FFFF	FFFF	FFFF	FFFF	FFFF	FFFF	FFFF	FFFF	FFFF	FFFF	FFFF	FFFF	FFFF	FFFF
	Char.																
C7E0	BIG5	FFFF	FFFF	FFFF	FFFF	FFFF	FFFF	FFFF	FFFF	FFFF	FFFF	FFFF	FFFF	FFFF	FFFF	FFFF	FFFF
	Char.																
C7F0	BIG5	FFFF	FFFF	FFFF	FFFF	FFFF	FFFF	FFFF	FFFF	FFFF	FFFF	FFFF	FFFF	FFFF	FFFF		
	Char.																
C840	BIG5		FFFF	FFFF	FFFF	FFFF	FFFF	FFFF	FFFF	FFFF	FFFF	FFFF	FFFF	FFFF	FFFF	FFFF	FFFF
	Char.																
C850	BIG5	FFFF	FFFF	FFFF	FFFF	FFFF	FFFF	FFFF	FFFF	FFFF	FFFF	FFFF	FFFF	FFFF	FFFF	FFFF	FFFF
	Char.																
C860	BIG5	FFFF	FFFF	FFFF	FFFF	FFFF	FFFF	FFFF	FFFF	FFFF	FFFF	FFFF	FFFF	FFFF	FFFF	FFFF	FFFF
	Char.																
C870	BIG5	FFFF	FFFF	FFFF	FFFF	FFFF	FFFF	FFFF	FFFF	FFFF	FFFF	FFFF	FFFF	FFFF	FFFF	FFFF	FFFF
	Char.																
C880	BIG5		FFFF	FFFF	FFFF	FFFF	FFFF	FFFF	FFFF	FFFF	FFFF	FFFF	FFFF	FFFF	FFFF	FFFF	FFFF
	Char.																
C890	BIG5	FFFF	FFFF	FFFF	FFFF	FFFF	FFFF	FFFF	FFFF	FFFF	FFFF	FFFF	FFFF	FFFF	FFFF	FFFF	FFFF
	Char.																
C8A0	BIG5	FFFF	FFFF	FFFF	FFFF	FFFF	FFFF	FFFF	FFFF	FFFF	FFFF	FFFF	FFFF	FFFF	FFFF	FFFF	FFFF
	Char.																
C8B0	BIG5	FFFF	FFFF	FFFF	FFFF	FFFF	FFFF	FFFF	FFFF	FFFF	FFFF	FFFF	FFFF	FFFF	FFFF	FFFF	FFFF
	Char.																

Table B-3 IBM à Big5 Conversion Table (continued)

IBM		+ 0	+ 1	+ 2	+ 3	+ 4	+ 5	+ 6	+ 7	+ 8	+ 9	+ A	+ B	+ C	+ D	+ E	+ F
C8C0	BIG5	FFFF	FFFF	FFFF	FFFF	FFFF	FFFF	FFFF	FFFF	FFFF	FFFF	FFFF	FFFF	FFFF	FFFF	FFFF	FFFF
	Char.																
C8D0	BIG5	FFFF	FFFF	FFFF	FFFF	FFFF	FFFF	FFFF	FFFF	FFFF	FFFF	FFFF	FFFF	FFFF	FFFF	FFFF	FFFF
	Char.																
C8E0	BIG5	FFFF	FFFF	FFFF	FFFF	FFFF	FFFF	FFFF	FFFF	FFFF	FFFF	FFFF	FFFF	FFFF	FFFF	FFFF	FFFF
	Char.																
C8F0	BIG5	FFFF	FFFF	FFFF	FFFF	FFFF	FFFF	FFFF	FFFF	FFFF	FFFF	FFFF	FFFF	FFFF	FFFF		
	Char.																
C940	BIG5		FFFF	FFFF	FFFF	FFFF	FFFF	FFFF	FFFF	FFFF	FFFF	FFFF	FFFF	FFFF	FFFF	FFFF	FFFF
	Char.																
C950	BIG5	FFFF	FFFF	FFFF	FFFF	FFFF	FFFF	FFFF	FFFF	FFFF	FFFF	FFFF	FFFF	FFFF	FFFF	FFFF	FFFF
	Char.																
C960	BIG5	FFFF	FFFF	FFFF	FFFF	FFFF	FFFF	FFFF	FFFF	FFFF	FFFF	FFFF	FFFF	FFFF	FFFF	FFFF	FFFF
	Char.																
C970	BIG5	FFFF	FFFF	FFFF	FFFF	FFFF	FFFF	FFFF	FFFF	FFFF	FFFF	FFFF	FFFF	FFFF	FFFF	FFFF	FFFF
	Char.																
C980	BIG5		FFFF	FFFF	FFFF	FFFF	FFFF	FFFF	FFFF	FFFF	FFFF	FFFF	FFFF	FFFF	FFFF	FFFF	FFFF
	Char.																
C990	BIG5	FFFF	FFFF	FFFF	FFFF	FFFF	FFFF	FFFF	FFFF	FFFF	FFFF	FFFF	FFFF	FFFF	FFFF	FFFF	FFFF
	Char.																
C9A0	BIG5	FFFF	FFFF	FFFF	FFFF	FFFF	FFFF	FFFF	FFFF	FFFF	FFFF	FFFF	FFFF	FFFF	FFFF	FFFF	FFFF
	Char.																
C9B0	BIG5	FFFF	FFFF	FFFF	FFFF	FFFF	FFFF	FFFF	FFFF	FFFF	FFFF	FFFF	FFFF	FFFF	FFFF	FFFF	FFFF
	Char.																

Table B-3 IBM à Big5 Conversion Table (continued)

IBM		+ 0	+ 1	+ 2	+ 3	+ 4	+ 5	+ 6	+ 7	+ 8	+ 9	+ A	+ B	+ C	+ D	+ E	+ F
C9C0	BIG5	FFFF	FFFF	FFFF	FFFF	FFFF	FFFF	FFFF	FFFF	FFFF	FFFF	FFFF	FFFF	FFFF	FFFF	FFFF	FFFF
	Char.																
C9D0	BIG5	FFFF	FFFF	FFFF	FFFF	FFFF	FFFF	FFFF	FFFF	FFFF	FFFF	FFFF	FFFF	FFFF	FFFF	FFFF	FFFF
	Char.																
C9E0	BIG5	FFFF	FFFF	FFFF	FFFF	FFFF	FFFF	FFFF	FFFF	FFFF	FFFF	FFFF	FFFF	FFFF	FFFF	FFFF	FFFF
	Char.																
C9F0	BIG5	FFFF	FFFF	FFFF	FFFF	FFFF	FFFF	FFFF	FFFF	FFFF	FFFF	FFFF	FFFF	FFFF	FFFF		
	Char.																
CA40	BIG5		FFFF	FFFF	FFFF	FFFF	FFFF	FFFF	FFFF	FFFF	FFFF	FFFF	FFFF	FFFF	FFFF	FFFF	FFFF
	Char.																
CA50	BIG5	FFFF	FFFF	FFFF	FFFF	FFFF	FFFF	FFFF	FFFF	FFFF	FFFF	FFFF	FFFF	FFFF	FFFF	FFFF	FFFF
	Char.																
CA60	BIG5	FFFF	FFFF	FFFF	FFFF	FFFF	FFFF	FFFF	FFFF	FFFF	FFFF	FFFF	FFFF	FFFF	FFFF	FFFF	FFFF
	Char.																
CA70	BIG5	FFFF	FFFF	FFFF	FFFF	FFFF	FFFF	FFFF	FFFF	FFFF	FFFF	FFFF	FFFF	FFFF	FFFF	FFFF	FFFF
	Char.																
CA80	BIG5		FFFF	FFFF	FFFF	FFFF	FFFF	FFFF	FFFF	FFFF	FFFF	FFFF	FFFF	FFFF	FFFF	FFFF	FFFF
	Char.																
CA90	BIG5	FFFF	FFFF	FFFF	FFFF	FFFF	FFFF	FFFF	FFFF	FFFF	FFFF	FFFF	FFFF	FFFF	FFFF	FFFF	FFFF
	Char.																
CAA0	BIG5	FFFF	FFFF	FFFF	FFFF	FFFF	FFFF	FFFF	FFFF	FFFF	FFFF	FFFF	FFFF	FFFF	FFFF	FFFF	FFFF
	Char.																

Table B-3 IBM à Big5 Conversion Table (continued)

IBM		+ 0	+ 1	+ 2	+ 3	+ 4	+ 5	+ 6	+ 7	+ 8	+ 9	+ A	+ B	+ C	+ D	+ E	+ F
CAB0	BIG5	FFFF	FFFF	FFFF	FFFF	FFFF	FFFF	FFFF	FFFF	FFFF	FFFF	FFFF	FFFF	FFFF	FFFF	FFFF	FFFF
	Char.																
CAC0	BIG5	FFFF	FFFF	FFFF	FFFF	FFFF	FFFF	FFFF	FFFF	FFFF	FFFF	FFFF	FFFF	FFFF	FFFF	FFFF	FFFF
	Char.																
CAD0	BIG5	FFFF	FFFF	FFFF	FFFF	FFFF	FFFF	FFFF	FFFF	FFFF	FFFF	FFFF	FFFF	FFFF	FFFF	FFFF	FFFF
	Char.																
CAE0	BIG5	FFFF	FFFF	FFFF	FFFF	FFFF	FFFF	FFFF	FFFF	FFFF	FFFF	FFFF	FFFF	FFFF	FFFF	FFFF	FFFF
	Char.																
CAF0	BIG5	FFFF	FFFF	FFFF	FFFF	FFFF	FFFF	FFFF	FFFF	FFFF	FFFF	FFFF	FFFF	FFFF	FFFF		
	Char.																
CB40	BIG5		FFFF	FFFF	FFFF	FFFF	FFFF	FFFF	FFFF	FFFF	FFFF	FFFF	FFFF	FFFF	FFFF	FFFF	FFFF
	Char.																
CB50	BIG5	FFFF	FFFF	FFFF	FFFF	FFFF	FFFF	FFFF	FFFF	FFFF	FFFF	FFFF	FFFF	FFFF	FFFF	FFFF	FFFF
	Char.																
CB60	BIG5	FFFF	FFFF	FFFF	FFFF	FFFF	FFFF	FFFF	FFFF	FFFF	FFFF	FFFF	FFFF	FFFF	FFFF	FFFF	FFFF
	Char.																
CB70	BIG5	FFFF	FFFF	FFFF	FFFF	FFFF	FFFF	FFFF	FFFF	FFFF	FFFF	FFFF	FFFF	FFFF	FFFF	FFFF	FFFF
	Char.																
CB80	BIG5		FFFF	FFFF	FFFF	FFFF	FFFF	FFFF	FFFF	FFFF	FFFF	FFFF	FFFF	FFFF	FFFF	FFFF	FFFF
	Char.																
CB90	BIG5	FFFF	FFFF	FFFF	FFFF	FFFF	FFFF	FFFF	FFFF	FFFF	FFFF	FFFF	FFFF	FFFF	FFFF	FFFF	FFFF
	Char.																

Table B-3 IBM à Big5 Conversion Table (continued)

IBM		+ 0	+ 1	+ 2	+ 3	+ 4	+ 5	+ 6	+ 7	+ 8	+ 9	+ A	+ B	+ C	+ D	+ E	+ F
CBA0	BIG5	FFFF	FFFF	FFFF	FFFF	FFFF	FFFF	FFFF	FFFF	FFFF	FFFF	FFFF	FFFF	FFFF	FFFF	FFFF	FFFF
	Char.																
CBB0	BIG5	FFFF	FFFF	FFFF	FFFF	FFFF	FFFF	FFFF	FFFF	FFFF	FFFF	FFFF	FFFF	FFFF	FFFF	FFFF	FFFF
	Char.																
CBC0	BIG5	FFFF	FFFF	FFFF	FFFF	FFFF	FFFF	FFFF	FFFF	FFFF	FFFF	FFFF	FFFF	FFFF	FFFF	FFFF	FFFF
	Char.																
CBD0	BIG5	FFFF	FFFF	FFFF	FFFF	FFFF	FFFF	FFFF	FFFF	FFFF	FFFF	FFFF	FFFF	FFFF	FFFF	FFFF	FFFF
	Char.																
CBE0	BIG5	FFFF	FFFF	FFFF	FFFF	FFFF	FFFF	FFFF	FFFF	FFFF	FFFF	FFFF	FFFF	FFFF	FFFF	FFFF	FFFF
	Char.																
CBF0	BIG5	FFFF	FFFF	FFFF	FFFF	FFFF	FFFF	FFFF	FFFF	FFFF	FFFF	FFFF	FFFF	FFFF	FFFF		
	Char.																
CC40	BIG5		FFFF	FFFF	FFFF	FFFF	FFFF	FFFF	FFFF	FFFF	FFFF	FFFF	FFFF	FFFF	FFFF	FFFF	FFFF
	Char.																
CC50	BIG5	FFFF	FFFF	FFFF	FFFF	FFFF	FFFF	FFFF	FFFF	FFFF	FFFF	FFFF	FFFF	FFFF	FFFF	FFFF	FFFF
	Char.																
CC60	BIG5	FFFF	FFFF	FFFF	FFFF	FFFF	FFFF	FFFF	FFFF	FFFF	FFFF	FFFF	FFFF	FFFF	FFFF	FFFF	FFFF
	Char.																
CC70	BIG5	FFFF	FFFF	FFFF	FFFF	FFFF	FFFF	FFFF	FFFF	FFFF	FFFF	FFFF	FFFF	FFFF	FFFF	FFFF	FFFF
	Char.																
CC80	BIG5		FFFF	FFFF	FFFF	FFFF	FFFF	FFFF	FFFF	FFFF	FFFF	FFFF	FFFF	FFFF	FFFF	FFFF	FFFF
	Char.																
CC90	BIG5	FFFF	FFFF	FFFF	FFFF	FFFF	FFFF	FFFF	FFFF	FFFF	FFFF	FFFF	FFFF	FFFF	FFFF	FFFF	FFFF
	Char.																

Table B-3 IBM à Big5 Conversion Table (continued)

IBM		+ 0	+ 1	+ 2	+ 3	+ 4	+ 5	+ 6	+ 7	+ 8	+ 9	+ A	+ B	+ C	+ D	+ E	+ F
CCA0	BIG5	FFFF	FFFF	FFFF	FFFF	FFFF	FFFF	FFFF	FFFF	FFFF	FFFF	FFFF	FFFF	FFFF	FFFF	FFFF	FFFF
	Char.																
CCB0	BIG5	FFFF	FFFF	FFFF	FFFF	FFFF	FFFF	FFFF	FFFF	FFFF	FFFF	FFFF	FFFF	FFFF	FFFF	FFFF	FFFF
	Char.																
CCC0	BIG5	FFFF	FFFF	FFFF	FFFF	FFFF	FFFF	FFFF	FFFF	FFFF	FFFF	FFFF	FFFF	FFFF	FFFF	FFFF	FFFF
	Char.																
CCD0	BIG5	FFFF	FFFF	FFFF	FFFF	FFFF	FFFF	FFFF	FFFF	FFFF	FFFF	FFFF	FFFF	FFFF	FFFF	FFFF	FFFF
	Char.																
CCE0	BIG5	FFFF	FFFF	FFFF	FFFF	FFFF	FFFF	FFFF	FFFF	FFFF	FFFF	FFFF	FFFF	FFFF	FFFF	FFFF	FFFF
	Char.																
CCF0	BIG5	FFFF	FFFF	FFFF	FFFF	FFFF	FFFF	FFFF	FFFF	FFFF	FFFF	FFFF	FFFF	FFFF	FFFF		
	Char.																
CD40	BIG5		FFFF	FFFF	FFFF	FFFF	FFFF	FFFF	FFFF	FFFF	FFFF	FFFF	FFFF	FFFF	FFFF	FFFF	FFFF
	Char.																
CD50	BIG5	FFFF	FFFF	FFFF	FFFF	FFFF	FFFF	FFFF	FFFF	FFFF	FFFF	FFFF	FFFF	FFFF	FFFF	FFFF	FFFF
	Char.																
CD60	BIG5	FFFF	FFFF	FFFF	FFFF	FFFF	FFFF	FFFF	FFFF	FFFF	FFFF	FFFF	FFFF	FFFF	FFFF	FFFF	FFFF
	Char.																
CD70	BIG5	FFFF	FFFF	FFFF	FFFF	FFFF	FFFF	FFFF	FFFF	FFFF	FFFF	FFFF	FFFF	FFFF	FFFF	FFFF	FFFF
	Char.																
CD80	BIG5		FFFF	FFFF	FFFF	FFFF	FFFF	FFFF	FFFF	FFFF	FFFF	FFFF	FFFF	FFFF	FFFF	FFFF	FFFF
	Char.																
CD90	BIG5	FFFF	FFFF	FFFF	FFFF	FFFF	FFFF	FFFF	FFFF	FFFF	FFFF	FFFF	FFFF	FFFF	FFFF	FFFF	FFFF
	Char.																

Table B-3 IBM à Big5 Conversion Table (continued)

IBM		+ 0	+ 1	+ 2	+ 3	+ 4	+ 5	+ 6	+ 7	+ 8	+ 9	+ A	+ B	+ C	+ D	+ E	+ F
CDA0	BIG5	FFFF	FFFF	FFFF	FFFF	FFFF	FFFF	FFFF	FFFF	FFFF	FFFF	FFFF	FFFF	FFFF	FFFF	FFFF	FFFF
	Char.																
CDB0	BIG5	FFFF	FFFF	FFFF	FFFF	FFFF	FFFF	FFFF	FFFF	FFFF	FFFF	FFFF	FFFF	FFFF	FFFF	FFFF	FFFF
	Char.																
CDC0	BIG5	FFFF	FFFF	FFFF	FFFF	FFFF	FFFF	FFFF	FFFF	FFFF	FFFF	FFFF	FFFF	FFFF	FFFF	FFFF	FFFF
	Char.																
CDD0	BIG5	FFFF	FFFF	FFFF	FFFF	FFFF	FFFF	FFFF	FFFF	FFFF	FFFF	FFFF	FFFF	FFFF	FFFF	FFFF	FFFF
	Char.																
CDE0	BIG5	FFFF	FFFF	FFFF	FFFF	FFFF	FFFF	FFFF	FFFF	FFFF	FFFF	FFFF	FFFF	FFFF	FFFF	FFFF	FFFF
	Char.																
CDF0	BIG5	FFFF	FFFF	FFFF	FFFF	FFFF	FFFF	FFFF	FFFF	FFFF	FFFF	FFFF	FFFF	FFFF	FFFF		
	Char.																
CE40	BIG5		FFFF	FFFF	FFFF	FFFF	FFFF	FFFF	FFFF	FFFF	FFFF	FFFF	FFFF	FFFF	FFFF	FFFF	FFFF
	Char.																
CE50	BIG5	FFFF	FFFF	FFFF	FFFF	FFFF	FFFF	FFFF	FFFF	FFFF	FFFF	FFFF	FFFF	FFFF	FFFF	FFFF	FFFF
	Char.																
CE60	BIG5	FFFF	FFFF	FFFF	FFFF	FFFF	FFFF	FFFF	FFFF	FFFF	FFFF	FFFF	FFFF	FFFF	FFFF	FFFF	FFFF
	Char.																
CE70	BIG5	FFFF	FFFF	FFFF	FFFF	FFFF	FFFF	FFFF	FFFF	FFFF	FFFF	FFFF	FFFF	FFFF	FFFF	FFFF	FFFF
	Char.																
CE80	BIG5		FFFF	FFFF	FFFF	FFFF	FFFF	FFFF	FFFF	FFFF	FFFF	FFFF	FFFF	FFFF	FFFF	FFFF	FFFF
	Char.																
CE90	BIG5	FFFF	FFFF	FFFF	FFFF	FFFF	FFFF	FFFF	FFFF	FFFF	FFFF	FFFF	FFFF	FFFF	FFFF	FFFF	FFFF
	Char.																

Table B-3 IBM à Big5 Conversion Table (continued)

IBM		+ 0	+ 1	+ 2	+ 3	+ 4	+ 5	+ 6	+ 7	+ 8	+ 9	+ A	+ B	+ C	+ D	+ E	+ F
CEA0	BIG5	FFFF	FFFF	FFFF	FFFF	FFFF	FFFF	FFFF	FFFF	FFFF	FFFF	FFFF	FFFF	FFFF	FFFF	FFFF	FFFF
	Char.																
CEB0	BIG5	FFFF	FFFF	FFFF	FFFF	FFFF	FFFF	FFFF	FFFF	FFFF	FFFF	FFFF	FFFF	FFFF	FFFF	FFFF	FFFF
	Char.																
CEC0	BIG5	FFFF	FFFF	FFFF	FFFF	FFFF	FFFF	FFFF	FFFF	FFFF	FFFF	FFFF	FFFF	FFFF	FFFF	FFFF	FFFF
	Char.																
CED0	BIG5	FFFF	FFFF	FFFF	FFFF	FFFF	FFFF	FFFF	FFFF	FFFF	FFFF	FFFF	FFFF	FFFF	FFFF	FFFF	FFFF
	Char.																
CEE0	BIG5	FFFF	FFFF	FFFF	FFFF	FFFF	FFFF	FFFF	FFFF	FFFF	FFFF	FFFF	FFFF	FFFF	FFFF	FFFF	FFFF
	Char.																
CEF0	BIG5	FFFF	FFFF	FFFF	FFFF	FFFF	FFFF	FFFF	FFFF	FFFF	FFFF	FFFF	FFFF	FFFF	FFFF		
	Char.																
CF40	BIG5		FFFF	FFFF	FFFF	FFFF	FFFF	FFFF	FFFF	FFFF	FFFF	FFFF	FFFF	FFFF	FFFF	FFFF	FFFF
	Char.																
CF50	BIG5	FFFF	FFFF	FFFF	FFFF	FFFF	FFFF	FFFF	FFFF	FFFF	FFFF	FFFF	FFFF	FFFF	FFFF	FFFF	FFFF
	Char.																
CF60	BIG5	FFFF	FFFF	FFFF	FFFF	FFFF	FFFF	FFFF	FFFF	FFFF	FFFF	FFFF	FFFF	FFFF	FFFF	FFFF	FFFF
	Char.																
CF70	BIG5	FFFF	FFFF	FFFF	FFFF	FFFF	FFFF	FFFF	FFFF	FFFF	FFFF	FFFF	FFFF	FFFF	FFFF	FFFF	FFFF
	Char.																
CF80	BIG5		FFFF	FFFF	FFFF	FFFF	FFFF	FFFF	FFFF	FFFF	FFFF	FFFF	FFFF	FFFF	FFFF	FFFF	FFFF
	Char.																
CF90	BIG5	FFFF	FFFF	FFFF	FFFF	FFFF	FFFF	FFFF	FFFF	FFFF	FFFF	FFFF	FFFF	FFFF	FFFF	FFFF	FFFF
	Char.																

Table B-3 IBM à Big5 Conversion Table (continued)

IBM		+ 0	+ 1	+ 2	+ 3	+ 4	+ 5	+ 6	+ 7	+ 8	+ 9	+ A	+ B	+ C	+ D	+ E	+ F
CFA0	BIG5	FFFF	FFFF	FFFF	FFFF	FFFF	FFFF	FFFF	FFFF	FFFF	FFFF	FFFF	FFFF	FFFF	FFFF	FFFF	FFFF
	Char.																
CFB0	BIG5	FFFF	FFFF	FFFF	FFFF	FFFF	FFFF	FFFF	FFFF	FFFF	FFFF	FFFF	FFFF	FFFF	FFFF	FFFF	FFFF
	Char.																
CFC0	BIG5	FFFF	FFFF	FFFF	FFFF	FFFF	FFFF	FFFF	FFFF	FFFF	FFFF	FFFF	FFFF	FFFF	FFFF	FFFF	FFFF
	Char.																
CFD0	BIG5	FFFF	FFFF	FFFF	FFFF	FFFF	FFFF	FFFF	FFFF	FFFF	FFFF	FFFF	FFFF	FFFF	FFFF	FFFF	FFFF
	Char.																
CFE0	BIG5	FFFF	FFFF	FFFF	FFFF	FFFF	FFFF	FFFF	FFFF	FFFF	FFFF	FFFF	FFFF	FFFF	FFFF	FFFF	FFFF
	Char.																
CFF0	BIG5	FFFF	FFFF	FFFF	FFFF	FFFF	FFFF	FFFF	FFFF	FFFF	FFFF	FFFF	FFFF	FFFF	FFFF		
	Char.																
D040	BIG5		FFFF	FFFF	FFFF	FFFF	FFFF	FFFF	FFFF	FFFF	FFFF	FFFF	FFFF	FFFF	FFFF	FFFF	FFFF
	Char.																
D050	BIG5	FFFF	FFFF	FFFF	FFFF	FFFF	FFFF	FFFF	FFFF	FFFF	FFFF	FFFF	FFFF	FFFF	FFFF	FFFF	FFFF
	Char.																
D060	BIG5	FFFF	FFFF	FFFF	FFFF	FFFF	FFFF	FFFF	FFFF	FFFF	FFFF	FFFF	FFFF	FFFF	FFFF	FFFF	FFFF
	Char.																
D070	BIG5	FFFF	FFFF	FFFF	FFFF	FFFF	FFFF	FFFF	FFFF	FFFF	FFFF	FFFF	FFFF	FFFF	FFFF	FFFF	FFFF
	Char.																
D080	BIG5		FFFF	FFFF	FFFF	FFFF	FFFF	FFFF	FFFF	FFFF	FFFF	FFFF	FFFF	FFFF	FFFF	FFFF	FFFF
	Char.																
D090	BIG5	FFFF	FFFF	FFFF	FFFF	FFFF	FFFF	FFFF	FFFF	FFFF	FFFF	FFFF	FFFF	FFFF	FFFF	FFFF	FFFF
	Char.																

Table B-3 IBM à Big5 Conversion Table (continued)

IBM		+ 0	+ 1	+ 2	+ 3	+ 4	+ 5	+ 6	+ 7	+ 8	+ 9	+ A	+ B	+ C	+ D	+ E	+ F
DOAO	BIG5	FFFF	FFFF	FFFF	FFFF	FFFF	FFFF	FFFF	FFFF	FFFF	FFFF	FFFF	FFFF	FFFF	FFFF	FFFF	FFFF
	Char.																
DOBO	BIG5	FFFF	FFFF	FFFF	FFFF	FFFF	FFFF	FFFF	FFFF	FFFF	FFFF	FFFF	FFFF	FFFF	FFFF	FFFF	FFFF
	Char.																
DOCO	BIG5	FFFF	FFFF	FFFF	FFFF	FFFF	FFFF	FFFF	FFFF	FFFF	FFFF	FFFF	FFFF	FFFF	FFFF	FFFF	FFFF
	Char.																
DODO	BIG5	FFFF	FFFF	FFFF	FFFF	FFFF	FFFF	FFFF	FFFF	FFFF	FFFF	FFFF	FFFF	FFFF	FFFF	FFFF	FFFF
	Char.																
DOEO	BIG5	FFFF	FFFF	FFFF	FFFF	FFFF	FFFF	FFFF	FFFF	FFFF	FFFF	FFFF	FFFF	FFFF	FFFF	FFFF	FFFF
	Char.																
DOFO	BIG5	FFFF	FFFF	FFFF	FFFF	FFFF	FFFF	FFFF	FFFF	FFFF	FFFF	FFFF	FFFF	FFFF	FFFF		
	Char.																
D140	BIG5		FFFF	FFFF	FFFF	FFFF	FFFF	FFFF	FFFF	FFFF	FFFF	FFFF	FFFF	FFFF	FFFF	FFFF	FFFF
	Char.																
D150	BIG5	FFFF	FFFF	FFFF	FFFF	FFFF	FFFF	FFFF	FFFF	FFFF	FFFF	FFFF	FFFF	FFFF	FFFF	FFFF	FFFF
	Char.																
D160	BIG5	FFFF	FFFF	FFFF	FFFF	FFFF	FFFF	FFFF	FFFF	FFFF	FFFF	FFFF	FFFF	FFFF	FFFF	FFFF	FFFF
	Char.																
D170	BIG5	FFFF	FFFF	FFFF	FFFF	FFFF	FFFF	FFFF	FFFF	FFFF	FFFF	FFFF	FFFF	FFFF	FFFF	FFFF	FFFF
	Char.																
D180	BIG5		FFFF	FFFF	FFFF	FFFF	FFFF	FFFF	FFFF	FFFF	FFFF	FFFF	FFFF	FFFF	FFFF	FFFF	FFFF
	Char.																
D190	BIG5	FFFF	FFFF	FFFF	FFFF	FFFF	FFFF	FFFF	FFFF	FFFF	FFFF	FFFF	FFFF	FFFF	FFFF	FFFF	FFFF
	Char.																

Table B-3 IBM à Big5 Conversion Table (continued)

IBM		+ 0	+ 1	+ 2	+ 3	+ 4	+ 5	+ 6	+ 7	+ 8	+ 9	+ A	+ B	+ C	+ D	+ E	+ F
D1A0	BIG5	FFFF	FFFF	FFFF	FFFF	FFFF	FFFF	FFFF	FFFF	FFFF	FFFF	FFFF	FFFF	FFFF	FFFF	FFFF	FFFF
	Char.																
D1B0	BIG5	FFFF	FFFF	FFFF	FFFF	FFFF	FFFF	FFFF	FFFF	FFFF	FFFF	FFFF	FFFF	FFFF	FFFF	FFFF	FFFF
	Char.																
D1C0	BIG5	FFFF	FFFF	FFFF	FFFF	FFFF	FFFF	FFFF	FFFF	FFFF	FFFF	FFFF	FFFF	FFFF	FFFF	FFFF	FFFF
	Char.																
D1D0	BIG5	FFFF	FFFF	FFFF	FFFF	FFFF	FFFF	FFFF	FFFF	FFFF	FFFF	FFFF	FFFF	FFFF	FFFF	FFFF	FFFF
	Char.																
D1E0	BIG5	FFFF	FFFF	FFFF	FFFF	FFFF	FFFF	FFFF	FFFF	FFFF	FFFF	FFFF	FFFF	FFFF	FFFF	FFFF	FFFF
	Char.																
D1F0	BIG5	FFFF	FFFF	FFFF	FFFF	FFFF	FFFF	FFFF	FFFF	FFFF	FFFF	FFFF	FFFF	FFFF	FFFF		
	Char.																
D240	BIG5		FFFF	FFFF	FFFF	FFFF	FFFF	FFFF	FFFF	FFFF	FFFF	FFFF	FFFF	FFFF	FFFF	FFFF	FFFF
	Char.																
D250	BIG5	FFFF	FFFF	FFFF	FFFF	FFFF	FFFF	FFFF	FFFF	FFFF	FFFF	FFFF	FFFF	FFFF	FFFF	FFFF	FFFF
	Char.																
D260	BIG5	FFFF	FFFF	FFFF	FFFF	FFFF	FFFF	FFFF	FFFF	FFFF	FFFF	FFFF	FFFF	FFFF	FFFF	FFFF	FFFF
	Char.																
D270	BIG5	FFFF	FFFF	FFFF	FFFF	FFFF	FFFF	FFFF	FFFF	FFFF	FFFF	FFFF	FFFF	FFFF	FFFF	FFFF	FFFF
	Char.																
D280	BIG5		FFFF	FFFF	FFFF	FFFF	FFFF	FFFF	FFFF	FFFF	FFFF	FFFF	FFFF	FFFF	FFFF	FFFF	FFFF
	Char.																
D290	BIG5	FFFF	FFFF	FFFF	FFFF	FFFF	FFFF	FFFF	FFFF	FFFF	FFFF	FFFF	FFFF	FFFF	FFFF	FFFF	FFFF
	Char.																

Table B-3 IBM à Big5 Conversion Table (continued)

IBM		+ 0	+ 1	+ 2	+ 3	+ 4	+ 5	+ 6	+ 7	+ 8	+ 9	+ A	+ B	+ C	+ D	+ E	+ F
D2A0	BIG5	FFFF	FFFF	FFFF	FFFF	FFFF	FFFF	FFFF	FFFF	FFFF	FFFF	FFFF	FFFF	FFFF	FFFF	FFFF	FFFF
	Char.																
D2B0	BIG5	FFFF	FFFF	FFFF	FFFF	FFFF	FFFF	FFFF	FFFF	FFFF	FFFF	FFFF	FFFF	FFFF	FFFF	FFFF	FFFF
	Char.																
D2C0	BIG5	FFFF	FFFF	FFFF	FFFF	FFFF	FFFF	FFFF	FFFF	FFFF	FFFF	FFFF	FFFF	FFFF	FFFF	FFFF	FFFF
	Char.																
D2D0	BIG5	FFFF	FFFF	FFFF	FFFF	FFFF	FFFF	FFFF	FFFF	FFFF	FFFF	FFFF	FFFF	FFFF	FFFF	FFFF	FFFF
	Char.																
D2E0	BIG5	FFFF	FFFF	FFFF	FFFF	FFFF	FFFF	FFFF	FFFF	FFFF	FFFF	FFFF	FFFF	FFFF	FFFF	FFFF	FFFF
	Char.																
D2F0	BIG5	FFFF	FFFF	FFFF	FFFF	FFFF	FFFF	FFFF	FFFF	FFFF	FFFF	FFFF	FFFF	FFFF	FFFF		
	Char.																
D340	BIG5		FFFF	FFFF	FFFF	FFFF	FFFF	FFFF	FFFF	FFFF	FFFF	FFFF	FFFF	FFFF	FFFF	FFFF	FFFF
	Char.																
D350	BIG5	FFFF	FFFF	FFFF	FFFF	FFFF	FFFF	FFFF	FFFF	FFFF	FFFF	FFFF	FFFF	FFFF	FFFF	FFFF	FFFF
	Char.																
D360	BIG5	FFFF	FFFF	FFFF	FFFF	FFFF	FFFF	FFFF	FFFF	FFFF	FFFF	FFFF	FFFF	FFFF	FFFF	FFFF	FFFF
	Char.																
D370	BIG5	FFFF	FFFF	FFFF	FFFF	FFFF	FFFF	FFFF	FFFF	FFFF	FFFF	FFFF	FFFF	FFFF	FFFF	FFFF	FFFF
	Char.																
D380	BIG5		FFFF	FFFF	FFFF	FFFF	FFFF	FFFF	FFFF	FFFF	FFFF	FFFF	FFFF	FFFF	FFFF	FFFF	FFFF
	Char.																
D390	BIG5	FFFF	FFFF	FFFF	FFFF	FFFF	FFFF	FFFF	FFFF	FFFF	FFFF	FFFF	FFFF	FFFF	FFFF	FFFF	FFFF
	Char.																

Table B-3 IBM à Big5 Conversion Table (continued)

IBM		+ 0	+ 1	+ 2	+ 3	+ 4	+ 5	+ 6	+ 7	+ 8	+ 9	+ A	+ B	+ C	+ D	+ E	+ F
D3A0	BIG5	FFFF	FFFF	FFFF	FFFF	FFFF	FFFF	FFFF	FFFF	FFFF	FFFF	FFFF	FFFF	FFFF	FFFF	FFFF	FFFF
	Char.																
D3B0	BIG5	FFFF	FFFF	FFFF	FFFF	FFFF	FFFF	FFFF	FFFF	FFFF	FFFF	FFFF	FFFF	FFFF	FFFF	FFFF	FFFF
	Char.																
D3C0	BIG5	FFFF	FFFF	FFFF	FFFF	FFFF	FFFF	FFFF	FFFF	FFFF	FFFF	FFFF	FFFF	FFFF	FFFF	FFFF	FFFF
	Char.																
D3D0	BIG5	FFFF	FFFF	FFFF	FFFF	FFFF	FFFF	FFFF	FFFF	FFFF	FFFF	FFFF	FFFF	FFFF	FFFF	FFFF	FFFF
	Char.																
D3E0	BIG5	FFFF	FFFF	FFFF	FFFF	FFFF	FFFF	FFFF	FFFF	FFFF	FFFF	FFFF	FFFF	FFFF	FFFF	FFFF	FFFF
	Char.																
D3F0	BIG5	FFFF	FFFF	FFFF	FFFF	FFFF	FFFF	FFFF	FFFF	FFFF	FFFF	FFFF	FFFF	FFFF	FFFF		
	Char.																
D440	BIG5		FFFF	FFFF	FFFF	FFFF	FFFF	FFFF	FFFF	FFFF	FFFF	FFFF	FFFF	FFFF	FFFF	FFFF	FFFF
	Char.																
D450	BIG5	FFFF	FFFF	FFFF	FFFF	FFFF	FFFF	FFFF	FFFF	FFFF	FFFF	FFFF	FFFF	FFFF	FFFF	FFFF	FFFF
	Char.																
D460	BIG5	FFFF	FFFF	FFFF	FFFF	FFFF	FFFF	FFFF	FFFF	FFFF	FFFF	FFFF	FFFF	FFFF	FFFF	FFFF	FFFF
	Char.																
D470	BIG5	FFFF	FFFF	FFFF	FFFF	FFFF	FFFF	FFFF	FFFF	FFFF	FFFF	FFFF	FFFF	FFFF	FFFF	FFFF	FFFF
	Char.																
D480	BIG5		FFFF	FFFF	FFFF	FFFF	FFFF	FFFF	FFFF	FFFF	FFFF	FFFF	FFFF	FFFF	FFFF	FFFF	FFFF
	Char.																
D490	BIG5	FFFF	FFFF	FFFF	FFFF	FFFF	FFFF	FFFF	FFFF	FFFF	FFFF	FFFF	FFFF	FFFF	FFFF	FFFF	FFFF
	Char.																

Table B-3 IBM à Big5 Conversion Table (continued)

IBM		+ 0	+ 1	+ 2	+ 3	+ 4	+ 5	+ 6	+ 7	+ 8	+ 9	+ A	+ B	+ C	+ D	+ E	+ F
D4A0	BIG5	FFFF	FFFF	FFFF	FFFF	FFFF	FFFF	FFFF	FFFF	FFFF	FFFF	FFFF	FFFF	FFFF	FFFF	FFFF	FFFF
	Char.																
D4B0	BIG5	FFFF	FFFF	FFFF	FFFF	FFFF	FFFF	FFFF	FFFF	FFFF	FFFF	FFFF	FFFF	FFFF	FFFF	FFFF	FFFF
	Char.																
D4C0	BIG5	FFFF	FFFF	FFFF	FFFF	FFFF	FFFF	FFFF	FFFF	FFFF	FFFF	FFFF	FFFF	FFFF	FFFF	FFFF	FFFF
	Char.																
D4D0	BIG5	FFFF	FFFF	FFFF	FFFF	FFFF	FFFF	FFFF	FFFF	FFFF	FFFF	FFFF	FFFF	FFFF	FFFF	FFFF	FFFF
	Char.																
D4E0	BIG5	FFFF	FFFF	FFFF	FFFF	FFFF	FFFF	FFFF	FFFF	FFFF	FFFF	FFFF	FFFF	FFFF	FFFF	FFFF	FFFF
	Char.																
D4F0	BIG5	FFFF	FFFF	FFFF	FFFF	FFFF	FFFF	FFFF	FFFF	FFFF	FFFF	FFFF	FFFF	FFFF	FFFF		
	Char.																
D540	BIG5		FFFF	FFFF	FFFF	FFFF	FFFF	FFFF	FFFF	FFFF	FFFF	FFFF	FFFF	FFFF	FFFF	FFFF	FFFF
	Char.																
D550	BIG5	FFFF	FFFF	FFFF	FFFF	FFFF	FFFF	FFFF	FFFF	FFFF	FFFF	FFFF	FFFF	FFFF	FFFF	FFFF	FFFF
	Char.																
D560	BIG5	FFFF	FFFF	FFFF	FFFF	FFFF	FFFF	FFFF	FFFF	FFFF	FFFF	FFFF	FFFF	FFFF	FFFF	FFFF	FFFF
	Char.																
D570	BIG5	FFFF	FFFF	FFFF	FFFF	FFFF	FFFF	FFFF	FFFF	FFFF	FFFF	FFFF	FFFF	FFFF	FFFF	FFFF	FFFF
	Char.																
D580	BIG5		FFFF	FFFF	FFFF	FFFF	FFFF	FFFF	FFFF	FFFF	FFFF	FFFF	FFFF	FFFF	FFFF	FFFF	FFFF
	Char.																
D590	BIG5	FFFF	FFFF	FFFF	FFFF	FFFF	FFFF	FFFF	FFFF	FFFF	FFFF	FFFF	FFFF	FFFF	FFFF	FFFF	FFFF
	Char.																

Table B-3 IBM à Big5 Conversion Table (continued)

IBM		+ 0	+ 1	+ 2	+ 3	+ 4	+ 5	+ 6	+ 7	+ 8	+ 9	+ A	+ B	+ C	+ D	+ E	+ F
D5A0	BIG5	FFFF	FFFF	FFFF	FFFF	FFFF	FFFF	FFFF	FFFF	FFFF	FFFF	FFFF	FFFF	FFFF	FFFF	FFFF	FFFF
	Char.																
D5B0	BIG5	FFFF	FFFF	FFFF	FFFF	FFFF	FFFF	FFFF	FFFF	FFFF	FFFF	FFFF	FFFF	FFFF	FFFF	FFFF	FFFF
	Char.																
D5C0	BIG5	FFFF	FFFF	FFFF	FFFF	FFFF	FFFF	FFFF	FFFF	FFFF	FFFF	FFFF	FFFF	FFFF	FFFF	FFFF	FFFF
	Char.																
D5D0	BIG5	FFFF	FFFF	FFFF	FFFF	FFFF	FFFF	FFFF	FFFF	FFFF	FFFF	FFFF	FFFF	FFFF	FFFF	FFFF	FFFF
	Char.																
D5E0	BIG5	FFFF	FFFF	FFFF	FFFF	FFFF	FFFF	FFFF	FFFF	FFFF	FFFF	FFFF	FFFF	FFFF	FFFF	FFFF	FFFF
	Char.																
D5F0	BIG5	FFFF	FFFF	FFFF	FFFF	FFFF	FFFF	FFFF	FFFF	FFFF	FFFF	FFFF	FFFF	FFFF	FFFF		
	Char.																
D640	BIG5		FFFF	FFFF	FFFF	FFFF	FFFF	FFFF	FFFF	FFFF	FFFF	FFFF	FFFF	FFFF	FFFF	FFFF	FFFF
	Char.																
D650	BIG5	FFFF	FFFF	FFFF	FFFF	FFFF	FFFF	FFFF	FFFF	FFFF	FFFF	FFFF	FFFF	FFFF	FFFF	FFFF	FFFF
	Char.																
D660	BIG5	FFFF	FFFF	FFFF	FFFF	FFFF	FFFF	FFFF	FFFF	FFFF	FFFF	FFFF	FFFF	FFFF	FFFF	FFFF	FFFF
	Char.																
D670	BIG5	FFFF	FFFF	FFFF	FFFF	FFFF	FFFF	FFFF	FFFF	FFFF	FFFF	FFFF	FFFF	FFFF	FFFF	FFFF	FFFF
	Char.																
D680	BIG5		FFFF	FFFF	FFFF	FFFF	FFFF	FFFF	FFFF	FFFF	FFFF	FFFF	FFFF	FFFF	FFFF	FFFF	FFFF
	Char.																

Table B-3 IBM à Big5 Conversion Table (continued)

IBM		+ 0	+ 1	+ 2	+ 3	+ 4	+ 5	+ 6	+ 7	+ 8	+ 9	+ A	+ B	+ C	+ D	+ E	+ F
D690	BIG5	FFFF	FFFF	FFFF	FFFF	FFFF	FFFF	FFFF	FFFF	FFFF	FFFF	FFFF	FFFF	FFFF	FFFF	FFFF	FFFF
	Char.																
D6A0	BIG5	FFFF	FFFF	FFFF	FFFF	FFFF	FFFF	FFFF	FFFF	FFFF	FFFF	FFFF	FFFF	FFFF	FFFF	FFFF	FFFF
	Char.																
D6B0	BIG5	FFFF	FFFF	FFFF	FFFF	FFFF	FFFF	FFFF	FFFF	FFFF	FFFF	FFFF	FFFF	FFFF	FFFF	FFFF	FFFF
	Char.																
D6C0	BIG5	FFFF	FFFF	FFFF	FFFF	FFFF	FFFF	FFFF	FFFF	FFFF	FFFF	FFFF	FFFF	FFFF	FFFF	FFFF	FFFF
	Char.																
D6D0	BIG5	FFFF	FFFF	FFFF	FFFF	FFFF	FFFF	FFFF	FFFF	FFFF	FFFF	FFFF	FFFF	FFFF	FFFF	FFFF	FFFF
	Char.																
D6E0	BIG5	FFFF	FFFF	FFFF	FFFF	FFFF	FFFF	FFFF	FFFF	FFFF	FFFF	FFFF	FFFF	FFFF	FFFF	FFFF	FFFF
	Char.																
D6F0	BIG5	FFFF	FFFF	FFFF	FFFF	FFFF	FFFF	FFFF	FFFF	FFFF	FFFF	FFFF	FFFF	FFFF	FFFF		
	Char.																
D740	BIG5		FFFF	FFFF	FFFF	FFFF	FFFF	FFFF	FFFF	FFFF	FFFF	FFFF	FFFF	FFFF	FFFF	FFFF	FFFF
	Char.																
D750	BIG5	FFFF	FFFF	FFFF	FFFF	FFFF	FFFF	FFFF	FFFF	FFFF	FFFF	FFFF	FFFF	FFFF	FFFF	FFFF	FFFF
	Char.																
D760	BIG5	FFFF	FFFF	FFFF	FFFF	FFFF	FFFF	FFFF	FFFF	FFFF	FFFF	FFFF	FFFF	FFFF	FFFF	FFFF	FFFF
	Char.																
D770	BIG5	FFFF	FFFF	FFFF	FFFF	FFFF	FFFF	FFFF	FFFF	FFFF	FFFF	FFFF	FFFF	FFFF	FFFF	FFFF	FFFF
	Char.																
D780	BIG5		FFFF	FFFF	FFFF	FFFF	FFFF	FFFF	FFFF	FFFF	FFFF	FFFF	FFFF	FFFF	FFFF	FFFF	FFFF
	Char.																

Table B-3 IBM à Big5 Conversion Table (continued)

IBM		+ 0	+ 1	+ 2	+ 3	+ 4	+ 5	+ 6	+ 7	+ 8	+ 9	+ A	+ B	+ C	+ D	+ E	+ F
D790	BIG5	FFFF	FFFF	FFFF	FFFF	FFFF	FFFF	FFFF	FFFF	FFFF	FFFF	FFFF	FFFF	FFFF	FFFF	FFFF	FFFF
	Char.																
D7A0	BIG5	FFFF	FFFF	FFFF	FFFF	FFFF	FFFF	FFFF	FFFF	FFFF	FFFF	FFFF	FFFF	FFFF	FFFF	FFFF	FFFF
	Char.																
D7B0	BIG5	FFFF	FFFF	FFFF	FFFF	FFFF	FFFF	FFFF	FFFF	FFFF	FFFF	FFFF	FFFF	FFFF	FFFF	FFFF	FFFF
	Char.																
D7C0	BIG5	FFFF	FFFF	FFFF	FFFF	FFFF	FFFF	FFFF	FFFF	FFFF	FFFF	FFFF	FFFF	FFFF	FFFF	FFFF	FFFF
	Char.																
D7D0	BIG5	FFFF	FFFF	FFFF	FFFF	FFFF	FFFF	FFFF	FFFF	FFFF	FFFF	FFFF	FFFF	FFFF	FFFF	FFFF	FFFF
	Char.																
D7E0	BIG5	FFFF	FFFF	FFFF	FFFF	FFFF	FFFF	FFFF	FFFF	FFFF	FFFF	FFFF	FFFF	FFFF	FFFF	FFFF	FFFF
	Char.																
D7F0	BIG5	FFFF	FFFF	FFFF	FFFF	FFFF	FFFF	FFFF	FFFF	FFFF	FFFF	FFFF	FFFF	FFFF	FFFF		
	Char.																
D840	BIG5		FFFF	FFFF	FFFF	FFFF	FFFF	FFFF	FFFF	FFFF	FFFF	FFFF	FFFF	FFFF	FFFF	FFFF	FFFF
	Char.																
D850	BIG5	FFFF	FFFF	FFFF	FFFF	FFFF	FFFF	FFFF	FFFF	FFFF	FFFF	FFFF	FFFF	FFFF	FFFF	FFFF	FFFF
	Char.																
D860	BIG5	FFFF	FFFF	FFFF	FFFF	FFFF	FFFF	FFFF	FFFF	FFFF	FFFF	FFFF	FFFF	FFFF	FFFF	FFFF	FFFF
	Char.																
D870	BIG5	FFFF	FFFF	FFFF	FFFF	FFFF	FFFF	FFFF	FFFF	FFFF	FFFF	FFFF	FFFF	FFFF	FFFF	FFFF	FFFF
	Char.																
D880	BIG5		FFFF	FFFF	FFFF	FFFF	FFFF	FFFF	FFFF	FFFF	FFFF	FFFF	FFFF	FFFF	FFFF	FFFF	FFFF
	Char.																

Table B-3 IBM à Big5 Conversion Table (continued)

IBM		+ 0	+ 1	+ 2	+ 3	+ 4	+ 5	+ 6	+ 7	+ 8	+ 9	+ A	+ B	+ C	+ D	+ E	+ F
D890	BIG5	FFFF	FFFF	FFFF	FFFF	FFFF	FFFF	FFFF	FFFF	FFFF	FFFF	FFFF	FFFF	FFFF	FFFF	FFFF	FFFF
	Char.																
D8A0	BIG5	FFFF	FFFF	FFFF	FFFF	FFFF	FFFF	FFFF	FFFF	FFFF	FFFF	FFFF	FFFF	FFFF	FFFF	FFFF	FFFF
	Char.																
D8B0	BIG5	FFFF	FFFF	FFFF	FFFF	FFFF	FFFF	FFFF	FFFF	FFFF	FFFF	FFFF	FFFF	FFFF	FFFF	FFFF	FFFF
	Char.																
D8C0	BIG5	FFFF	FFFF	FFFF	FFFF	FFFF	FFFF	FFFF	FFFF	FFFF	FFFF	FFFF	FFFF	FFFF	FFFF	FFFF	FFFF
	Char.																
D8D0	BIG5	FFFF	FFFF	FFFF	FFFF	FFFF	FFFF	FFFF	FFFF	FFFF	FFFF	FFFF	FFFF	FFFF	FFFF	FFFF	FFFF
	Char.																
D8E0	BIG5	FFFF	FFFF	FFFF	FFFF	FFFF	FFFF	FFFF	FFFF	FFFF	FFFF	FFFF	FFFF	FFFF	FFFF	FFFF	FFFF
	Char.																
D8F0	BIG5	FFFF	FFFF	FFFF	FFFF	FFFF	FFFF	FFFF	FFFF	FFFF	FFFF	FFFF	FFFF	FFFF	FFFF		
	Char.																
D940	BIG5		FFFF	FFFF	FFFF	FFFF	FFFF	FFFF	FFFF	FFFF	FFFF	FFFF	FFFF	FFFF	FFFF	FFFF	FFFF
	Char.																
D950	BIG5	FFFF	FFFF	FFFF	FFFF	FFFF	FFFF	FFFF	FFFF	FFFF	FFFF	FFFF	FFFF	FFFF	FFFF	FFFF	FFFF
	Char.																
D960	BIG5	FFFF	FFFF	FFFF	FFFF	FFFF	FFFF	FFFF	FFFF	FFFF	FFFF	FFFF	FFFF	FFFF	FFFF	FFFF	FFFF
	Char.																
D970	BIG5	FFFF	FFFF	FFFF	FFFF	FFFF	FFFF	FFFF	FFFF	FFFF	FFFF	FFFF	FFFF	FFFF	FFFF	FFFF	FFFF
	Char.																

Table B-3 IBM à Big5 Conversion Table (continued)

IBM		+ 0	+ 1	+ 2	+ 3	+ 4	+ 5	+ 6	+ 7	+ 8	+ 9	+ A	+ B	+ C	+ D	+ E	+ F
D980	BIG5		FFFF	FFFF	FFFF	FFFF	FFFF	FFFF	FFFF	FFFF	FFFF	FFFF	FFFF	FFFF	FFFF	FFFF	FFFF
	Char.																
D990	BIG5	FFFF	FFFF	FFFF	FFFF	FFFF	FFFF	FFFF	FFFF	FFFF	FFFF	FFFF	FFFF	FFFF	FFFF	FFFF	FFFF
	Char.																
D9A0	BIG5	FFFF	FFFF	FFFF	FFFF	FFFF	FFFF	FFFF	FFFF	FFFF	FFFF	FFFF	FFFF	FFFF	FFFF	FFFF	FFFF
	Char.																
D9B0	BIG5	FFFF	FFFF	FFFF	FFFF	FFFF	FFFF	FFFF	FFFF	FFFF	FFFF	FFFF	FFFF	FFFF	FFFF	FFFF	FFFF
	Char.																
D9C0	BIG5	FFFF	FFFF	FFFF	FFFF	FFFF	FFFF	FFFF	FFFF	FFFF	FFFF	FFFF	FFFF	FFFF	FFFF	FFFF	FFFF
	Char.																
D9D0	BIG5	FFFF	FFFF	FFFF	FFFF	FFFF	FFFF	FFFF	FFFF	FFFF	FFFF	FFFF	FFFF	FFFF	FFFF	FFFF	FFFF
	Char.																
D9E0	BIG5	FFFF	FFFF	FFFF	FFFF	FFFF	FFFF	FFFF	FFFF	FFFF	FFFF	FFFF	FFFF	FFFF	FFFF	FFFF	FFFF
	Char.																
D9F0	BIG5	FFFF	FFFF	FFFF	FFFF	FFFF	FFFF	FFFF	FFFF	FFFF	FFFF	FFFF	FFFF	FFFF	FFFF		
	Char.																
DA40	BIG5		FFFF	FFFF	FFFF	FFFF	FFFF	FFFF	FFFF	FFFF	FFFF	FFFF	FFFF	FFFF	FFFF	FFFF	FFFF
	Char.																
DA50	BIG5	FFFF	FFFF	FFFF	FFFF	FFFF	FFFF	FFFF	FFFF	FFFF	FFFF	FFFF	FFFF	FFFF	FFFF	FFFF	FFFF
	Char.																
DA60	BIG5	FFFF	FFFF	FFFF	FFFF	FFFF	FFFF	FFFF	FFFF	FFFF	FFFF	FFFF	FFFF	FFFF	FFFF	FFFF	FFFF
	Char.																
DA70	BIG5	FFFF	FFFF	FFFF	FFFF	FFFF	FFFF	FFFF	FFFF	FFFF	FFFF	FFFF	FFFF	FFFF	FFFF	FFFF	FFFF
	Char.																

Table B-3 IBM à Big5 Conversion Table (continued)

IBM		+ 0	+ 1	+ 2	+ 3	+ 4	+ 5	+ 6	+ 7	+ 8	+ 9	+ A	+ B	+ C	+ D	+ E	+ F
DA80	BIG5		FFFF	FFFF	FFFF	FFFF	FFFF	FFFF	FFFF	FFFF	FFFF	FFFF	FFFF	FFFF	FFFF	FFFF	FFFF
	Char.																
DA90	BIG5	FFFF	FFFF	FFFF	FFFF	FFFF	FFFF	FFFF	FFFF	FFFF	FFFF	FFFF	FFFF	FFFF	FFFF	FFFF	FFFF
	Char.																
DAA0	BIG5	FFFF	FFFF	FFFF	FFFF	FFFF	FFFF	FFFF	FFFF	FFFF	FFFF	FFFF	FFFF	FFFF	FFFF	FFFF	FFFF
	Char.																
DAB0	BIG5	FFFF	FFFF	FFFF	FFFF	FFFF	FFFF	FFFF	FFFF	FFFF	FFFF	FFFF	FFFF	FFFF	FFFF	FFFF	FFFF
	Char.																
DAC0	BIG5	FFFF	FFFF	FFFF	FFFF	FFFF	FFFF	FFFF	FFFF	FFFF	FFFF	FFFF	FFFF	FFFF	FFFF	FFFF	FFFF
	Char.																
DAD0	BIG5	FFFF	FFFF	FFFF	FFFF	FFFF	FFFF	FFFF	FFFF	FFFF	FFFF	FFFF	FFFF	FFFF	FFFF	FFFF	FFFF
	Char.																
DAE0	BIG5	FFFF	FFFF	FFFF	FFFF	FFFF	FFFF	FFFF	FFFF	FFFF	FFFF	FFFF	FFFF	FFFF	FFFF	FFFF	FFFF
	Char.																
DAF0	BIG5	FFFF	FFFF	FFFF	FFFF	FFFF	FFFF	FFFF	FFFF	FFFF	FFFF	FFFF	FFFF	FFFF	FFFF		
	Char.																
DB40	BIG5		FFFF	FFFF	FFFF	FFFF	FFFF	FFFF	FFFF	FFFF	FFFF	FFFF	FFFF	FFFF	FFFF	FFFF	FFFF
	Char.																
DB50	BIG5	FFFF	FFFF	FFFF	FFFF	FFFF	FFFF	FFFF	FFFF	FFFF	FFFF	FFFF	FFFF	FFFF	FFFF	FFFF	FFFF
	Char.																
DB60	BIG5	FFFF	FFFF	FFFF	FFFF	FFFF	FFFF	FFFF	FFFF	FFFF	FFFF	FFFF	FFFF	FFFF	FFFF	FFFF	FFFF
	Char.																
DB70	BIG5	FFFF	FFFF	FFFF	FFFF	FFFF	FFFF	FFFF	FFFF	FFFF	FFFF	FFFF	FFFF	FFFF	FFFF	FFFF	FFFF
	Char.																

Table B-3 IBM à Big5 Conversion Table (continued)

IBM		+ 0	+ 1	+ 2	+ 3	+ 4	+ 5	+ 6	+ 7	+ 8	+ 9	+ A	+ B	+ C	+ D	+ E	+ F
DB80	BIG5		FFFF	FFFF	FFFF	FFFF	FFFF	FFFF	FFFF	FFFF	FFFF	FFFF	FFFF	FFFF	FFFF	FFFF	FFFF
	Char.																
DB90	BIG5	FFFF	FFFF	FFFF	FFFF	FFFF	FFFF	FFFF	FFFF	FFFF	FFFF	FFFF	FFFF	FFFF	FFFF	FFFF	FFFF
	Char.																
DBA0	BIG5	FFFF	FFFF	FFFF	FFFF	FFFF	FFFF	FFFF	FFFF	FFFF	FFFF	FFFF	FFFF	FFFF	FFFF	FFFF	FFFF
	Char.																
DBB0	BIG5	FFFF	FFFF	FFFF	FFFF	FFFF	FFFF	FFFF	FFFF	FFFF	FFFF	FFFF	FFFF	FFFF	FFFF	FFFF	FFFF
	Char.																
DBC0	BIG5	FFFF	FFFF	FFFF	FFFF	FFFF	FFFF	FFFF	FFFF	FFFF	FFFF	FFFF	FFFF	FFFF	FFFF	FFFF	FFFF
	Char.																
DBD0	BIG5	FFFF	FFFF	FFFF	FFFF	FFFF	FFFF	FFFF	FFFF	FFFF	FFFF	FFFF	FFFF	FFFF	FFFF	FFFF	FFFF
	Char.																
DBE0	BIG5	FFFF	FFFF	FFFF	FFFF	FFFF	FFFF	FFFF	FFFF	FFFF	FFFF	FFFF	FFFF	FFFF	FFFF	FFFF	FFFF
	Char.																
DBF0	BIG5	FFFF	FFFF	FFFF	FFFF	FFFF	FFFF	FFFF	FFFF	FFFF	FFFF	FFFF	FFFF	FFFF	FFFF		
	Char.																
DC40	BIG5		FFFF	FFFF	FFFF	FFFF	FFFF	FFFF	FFFF	FFFF	FFFF	FFFF	FFFF	FFFF	FFFF	FFFF	FFFF
	Char.																
DC50	BIG5	FFFF	FFFF	FFFF	FFFF	FFFF	FFFF	FFFF	FFFF	FFFF	FFFF	FFFF	FFFF	FFFF	FFFF	FFFF	FFFF
	Char.																
DC60	BIG5	FFFF	FFFF	FFFF	FFFF	FFFF	FFFF	FFFF	FFFF	FFFF	FFFF	FFFF	FFFF	FFFF	FFFF	FFFF	FFFF
	Char.																
DC70	BIG5	FFFF	FFFF	FFFF	FFFF	FFFF	FFFF	FFFF	FFFF	FFFF	FFFF	FFFF	FFFF	FFFF	FFFF	FFFF	FFFF
	Char.																

Table B-3 IBM à Big5 Conversion Table (continued)

IBM		+ 0	+ 1	+ 2	+ 3	+ 4	+ 5	+ 6	+ 7	+ 8	+ 9	+ A	+ B	+ C	+ D	+ E	+ F
DC80	BIG5		FFFF	FFFF	FFFF	FFFF	FFFF	FFFF	FFFF	FFFF	FFFF	FFFF	FFFF	FFFF	FFFF	FFFF	FFFF
	Char.																
DC90	BIG5	FFFF	FFFF	FFFF	FFFF	FFFF	FFFF	FFFF	FFFF	FFFF	FFFF	FFFF	FFFF	FFFF	FFFF	FFFF	FFFF
	Char.																
DCA0	BIG5	FFFF	FFFF	FFFF	FFFF	FFFF	FFFF	FFFF	FFFF	FFFF	FFFF	FFFF	FFFF	FFFF	FFFF	FFFF	FFFF
	Char.																
DCB0	BIG5	FFFF	FFFF	FFFF	FFFF	FFFF	FFFF	FFFF	FFFF	FFFF	FFFF	FFFF	FFFF	FFFF	FFFF	FFFF	FFFF
	Char.																
DCC0	BIG5	FFFF	FFFF	FFFF	FFFF	FFFF	FFFF	FFFF	FFFF	FFFF	FFFF	FFFF	FFFF	FFFF	FFFF	FFFF	FFFF
	Char.																
DCD0	BIG5	FFFF	FFFF	FFFF	FFFF	FFFF	FFFF	FFFF	FFFF	FFFF	FFFF	FFFF	FFFF	FFFF	FFFF	FFFF	FFFF
	Char.																
DCE0	BIG5	FFFF	FFFF	FFFF	FFFF	FFFF	FFFF	FFFF	FFFF	FFFF	FFFF	FFFF	FFFF	FFFF	FFFF	FFFF	FFFF
	Char.																
DCF0	BIG5	FFFF	FFFF	FFFF	FFFF	FFFF	FFFF	FFFF	FFFF	FFFF	FFFF	FFFF	FFFF	FFFF	FFFF		
	Char.																
DD40	BIG5		FFFF	FFFF	FFFF	FFFF	FFFF	FFFF	FFFF	FFFF	FFFF	FFFF	FFFF	FFFF	FFFF	FFFF	FFFF
	Char.																
DD50	BIG5	FFFF	FFFF	FFFF	FFFF	FFFF	FFFF	FFFF	FFFF	FFFF	FFFF	FFFF	FFFF	FFFF	FFFF	FFFF	FFFF
	Char.																
DD60	BIG5	FFFF	FFFF	FFFF	FFFF	FFFF	FFFF	FFFF	FFFF	FFFF	FFFF	FFFF	FFFF	FFFF	FFFF	FFFF	FFFF
	Char.																
DD70	BIG5	FFFF	FFFF	FFFF	FFFF	FFFF	FFFF	FFFF	FFFF	FFFF	FFFF	FFFF	FFFF	FFFF	FFFF	FFFF	FFFF
	Char.																

Table B-3 IBM à Big5 Conversion Table (continued)

IBM		+ 0	+ 1	+ 2	+ 3	+ 4	+ 5	+ 6	+ 7	+ 8	+ 9	+ A	+ B	+ C	+ D	+ E	+ F
DD80	BIG5		FFFF	FFFF	FFFF	FFFF	FFFF	FFFF	FFFF	FFFF	FFFF	FFFF	FFFF	FFFF	FFFF	FFFF	FFFF
	Char.																
DD90	BIG5	FFFF	FFFF	FFFF	FFFF	FFFF	FFFF	FFFF	FFFF	FFFF	FFFF	FFFF	FFFF	FFFF	FFFF	FFFF	FFFF
	Char.																
DDA0	BIG5	FFFF	FFFF	FFFF	FFFF	FFFF	FFFF	FFFF	FFFF	FFFF	FFFF	FFFF	FFFF	FFFF	FFFF	FFFF	FFFF
	Char.																
DDB0	BIG5	FFFF	FFFF	FFFF	FFFF	FFFF	FFFF	FFFF	FFFF	FFFF	FFFF	FFFF	FFFF	FFFF	FFFF	FFFF	FFFF
	Char.																
DDC0	BIG5	FFFF	FFFF	FFFF	FFFF	FFFF	FFFF	FFFF	FFFF	FFFF	FFFF	FFFF	FFFF	FFFF	FFFF	FFFF	FFFF
	Char.																
DDD0	BIG5	FFFF	FFFF	FFFF	FFFF	FFFF	FFFF	FFFF	FFFF	FFFF	FFFF	FFFF	FFFF	FFFF	FFFF	FFFF	FFFF
	Char.																
DDE0	BIG5	FFFF	FFFF	FFFF	FFFF	FFFF	FFFF	FFFF	FFFF	FFFF	FFFF	FFFF	FFFF	FFFF	FFFF	FFFF	FFFF
	Char.																
DDF0	BIG5	FFFF	FFFF	FFFF	FFFF	FFFF	FFFF	FFFF	FFFF	FFFF	FFFF	FFFF	FFFF	FFFF	FFFF		
	Char.																
DE40	BIG5		FFFF	FFFF	FFFF	FFFF	FFFF	FFFF	FFFF	FFFF	FFFF	FFFF	FFFF	FFFF	FFFF	FFFF	FFFF
	Char.																
DE50	BIG5	FFFF	FFFF	FFFF	FFFF	FFFF	FFFF	FFFF	FFFF	FFFF	FFFF	FFFF	FFFF	FFFF	FFFF	FFFF	FFFF
	Char.																
DE60	BIG5	FFFF	FFFF	FFFF	FFFF	FFFF	FFFF	FFFF	FFFF	FFFF	FFFF	FFFF	FFFF	FFFF	FFFF	FFFF	FFFF
	Char.																

Table B-3 IBM à Big5 Conversion Table (continued)

IBM		+ 0	+ 1	+ 2	+ 3	+ 4	+ 5	+ 6	+ 7	+ 8	+ 9	+ A	+ B	+ C	+ D	+ E	+ F
DE70	BIG5	FFFF	FFFF	FFFF	FFFF	FFFF	FFFF	FFFF	FFFF	FFFF	FFFF	FFFF	FFFF	FFFF	FFFF	FFFF	FFFF
	Char.																
DE80	BIG5		FFFF	FFFF	FFFF	FFFF	FFFF	FFFF	FFFF	FFFF	FFFF	FFFF	FFFF	FFFF	FFFF	FFFF	FFFF
	Char.																
DE90	BIG5	FFFF	FFFF	FFFF	FFFF	FFFF	FFFF	FFFF	FFFF	FFFF	FFFF	FFFF	FFFF	FFFF	FFFF	FFFF	FFFF
	Char.																
DEA0	BIG5	FFFF	FFFF	FFFF	FFFF	FFFF	FFFF	FFFF	FFFF	FFFF	FFFF	FFFF	FFFF	FFFF	FFFF	FFFF	FFFF
	Char.																
DEB0	BIG5	FFFF	FFFF	FFFF	FFFF	FFFF	FFFF	FFFF	FFFF	FFFF	FFFF	FFFF	FFFF	FFFF	FFFF	FFFF	FFFF
	Char.																
DECO	BIG5	FFFF	FFFF	FFFF	FFFF	FFFF	FFFF	FFFF	FFFF	FFFF	FFFF	FFFF	FFFF	FFFF	FFFF	FFFF	FFFF
	Char.																
DED0	BIG5	FFFF	FFFF	FFFF	FFFF	FFFF	FFFF	FFFF	FFFF	FFFF	FFFF	FFFF	FFFF	FFFF	FFFF	FFFF	FFFF
	Char.																
DEE0	BIG5	FFFF	FFFF	FFFF	FFFF	FFFF	FFFF	FFFF	FFFF	FFFF	FFFF	FFFF	FFFF	FFFF	FFFF	FFFF	FFFF
	Char.																
DEF0	BIG5	FFFF	FFFF	FFFF	FFFF	FFFF	FFFF	FFFF	FFFF	FFFF	FFFF	FFFF	FFFF	FFFF	FFFF		
	Char.																
DF40	BIG5		FFFF	FFFF	FFFF	FFFF	FFFF	FFFF	FFFF	FFFF	FFFF	FFFF	FFFF	FFFF	FFFF	FFFF	FFFF
	Char.																
DF50	BIG5	FFFF	FFFF	FFFF	FFFF	FFFF	FFFF	FFFF	FFFF	FFFF	FFFF	FFFF	FFFF	FFFF	FFFF	FFFF	FFFF
	Char.																
DF60	BIG5	FFFF	FFFF	FFFF	FFFF	FFFF	FFFF	FFFF	FFFF	FFFF	FFFF	FFFF	FFFF	FFFF	FFFF	FFFF	FFFF
	Char.																

Table B-3 IBM à Big5 Conversion Table (continued)

IBM		+ 0	+ 1	+ 2	+ 3	+ 4	+ 5	+ 6	+ 7	+ 8	+ 9	+ A	+ B	+ C	+ D	+ E	+ F
DF70	BIG5	FFFF	FFFF	FFFF	FFFF	FFFF	FFFF	FFFF	FFFF	FFFF	FFFF	FFFF	FFFF	FFFF	FFFF	FFFF	FFFF
	Char.																
DF80	BIG5		FFFF	FFFF	FFFF	FFFF	FFFF	FFFF	FFFF	FFFF	FFFF	FFFF	FFFF	FFFF	FFFF	FFFF	FFFF
	Char.																
DF90	BIG5	FFFF	FFFF	FFFF	FFFF	FFFF	FFFF	FFFF	FFFF	FFFF	FFFF	FFFF	FFFF	FFFF	FFFF	FFFF	FFFF
	Char.																
DFA0	BIG5	FFFF	FFFF	FFFF	FFFF	FFFF	FFFF	FFFF	FFFF	FFFF	FFFF	FFFF	FFFF	FFFF	FFFF	FFFF	FFFF
	Char.																
DFB0	BIG5	FFFF	FFFF	FFFF	FFFF	FFFF	FFFF	FFFF	FFFF	FFFF	FFFF	FFFF	FFFF	FFFF	FFFF	FFFF	FFFF
	Char.																
DFC0	BIG5	FFFF	FFFF	FFFF	FFFF	FFFF	FFFF	FFFF	FFFF	FFFF	FFFF	FFFF	FFFF	FFFF	FFFF	FFFF	FFFF
	Char.																
DFD0	BIG5	FFFF	FFFF	FFFF	FFFF	FFFF	FFFF	FFFF	FFFF	FFFF	FFFF	FFFF	FFFF	FFFF	FFFF	FFFF	FFFF
	Char.																
DFE0	BIG5	FFFF	FFFF	FFFF	FFFF	FFFF	FFFF	FFFF	FFFF	FFFF	FFFF	FFFF	FFFF	FFFF	FFFF	FFFF	FFFF
	Char.																
DFF0	BIG5	FFFF	FFFF	FFFF	FFFF	FFFF	FFFF	FFFF	FFFF	FFFF	FFFF	FFFF	FFFF	FFFF	FFFF		
	Char.																
E040	BIG5		FFFF	FFFF	FFFF	FFFF	FFFF	FFFF	FFFF	FFFF	FFFF	FFFF	FFFF	FFFF	FFFF	FFFF	FFFF
	Char.																
E050	BIG5	FFFF	FFFF	FFFF	FFFF	FFFF	FFFF	FFFF	FFFF	FFFF	FFFF	FFFF	FFFF	FFFF	FFFF	FFFF	FFFF
	Char.																
E060	BIG5	FFFF	FFFF	FFFF	FFFF	FFFF	FFFF	FFFF	FFFF	FFFF	FFFF	FFFF	FFFF	FFFF	FFFF	FFFF	FFFF
	Char.																

Table B-3 IBM à Big5 Conversion Table (continued)

IBM		+ 0	+ 1	+ 2	+ 3	+ 4	+ 5	+ 6	+ 7	+ 8	+ 9	+ A	+ B	+ C	+ D	+ E	+ F
E070	BIG5	FFFF	FFFF	FFFF	FFFF	FFFF	FFFF	FFFF	FFFF	FFFF	FFFF	FFFF	FFFF	FFFF	FFFF	FFFF	FFFF
	Char.																
E080	BIG5		FFFF	FFFF	FFFF	FFFF	FFFF	FFFF	FFFF	FFFF	FFFF	FFFF	FFFF	FFFF	FFFF	FFFF	FFFF
	Char.																
E090	BIG5	FFFF	FFFF	FFFF	FFFF	FFFF	FFFF	FFFF	FFFF	FFFF	FFFF	FFFF	FFFF	FFFF	FFFF	FFFF	FFFF
	Char.																
EOA0	BIG5	FFFF	FFFF	FFFF	FFFF	FFFF	FFFF	FFFF	FFFF	FFFF	FFFF	FFFF	FFFF	FFFF	FFFF	FFFF	FFFF
	Char.																
EOB0	BIG5	FFFF	FFFF	FFFF	FFFF	FFFF	FFFF	FFFF	FFFF	FFFF	FFFF	FFFF	FFFF	FFFF	FFFF	FFFF	FFFF
	Char.																
EOC0	BIG5	FFFF	FFFF	FFFF	FFFF	FFFF	FFFF	FFFF	FFFF	FFFF	FFFF	FFFF	FFFF	FFFF	FFFF	FFFF	FFFF
	Char.																
EOD0	BIG5	FFFF	FFFF	FFFF	FFFF	FFFF	FFFF	FFFF	FFFF	FFFF	FFFF	FFFF	FFFF	FFFF	FFFF	FFFF	FFFF
	Char.																
EOE0	BIG5	FFFF	FFFF	FFFF	FFFF	FFFF	FFFF	FFFF	FFFF	FFFF	FFFF	FFFF	FFFF	FFFF	FFFF	FFFF	FFFF
	Char.																
EOF0	BIG5	FFFF	FFFF	FFFF	FFFF	FFFF	FFFF	FFFF	FFFF	FFFF	FFFF	FFFF	FFFF	FFFF	FFFF	FFFF	
	Char.																
E140	BIG5		FFFF	FFFF	FFFF	FFFF	FFFF	FFFF	FFFF	FFFF	FFFF	FFFF	FFFF	FFFF	FFFF	FFFF	FFFF
	Char.																
E150	BIG5	FFFF	FFFF	FFFF	FFFF	FFFF	FFFF	FFFF	FFFF	FFFF	FFFF	FFFF	FFFF	FFFF	FFFF	FFFF	FFFF
	Char.																
E160	BIG5	FFFF	FFFF	FFFF	FFFF	FFFF	FFFF	FFFF	FFFF	FFFF	FFFF	FFFF	FFFF	FFFF	FFFF	FFFF	FFFF
	Char.																

Table B-3 IBM à Big5 Conversion Table (continued)

IBM		+ 0	+ 1	+ 2	+ 3	+ 4	+ 5	+ 6	+ 7	+ 8	+ 9	+ A	+ B	+ C	+ D	+ E	+ F
E170	BIG5	FFFF	FFFF	FFFF	FFFF	FFFF	FFFF	FFFF	FFFF	FFFF	FFFF	FFFF	FFFF	FFFF	FFFF	FFFF	FFFF
	Char.																
E180	BIG5		FFFF	FFFF	FFFF	FFFF	FFFF	FFFF	FFFF	FFFF	FFFF	FFFF	FFFF	FFFF	FFFF	FFFF	FFFF
	Char.																
E190	BIG5	FFFF	FFFF	FFFF	FFFF	FFFF	FFFF	FFFF	FFFF	FFFF	FFFF	FFFF	FFFF	FFFF	FFFF	FFFF	FFFF
	Char.																
E1A0	BIG5	FFFF	FFFF	FFFF	FFFF	FFFF	FFFF	FFFF	FFFF	FFFF	FFFF	FFFF	FFFF	FFFF	FFFF	FFFF	FFFF
	Char.																
E1B0	BIG5	FFFF	FFFF	FFFF	FFFF	FFFF	FFFF	FFFF	FFFF	FFFF	FFFF	FFFF	FFFF	FFFF	FFFF	FFFF	FFFF
	Char.																
E1C0	BIG5	FFFF	FFFF	FFFF	FFFF	FFFF	FFFF	FFFF	FFFF	FFFF	FFFF	FFFF	FFFF	FFFF	FFFF	FFFF	FFFF
	Char.																
E1D0	BIG5	FFFF	FFFF	FFFF	FFFF	FFFF	FFFF	FFFF	FFFF	FFFF	FFFF	FFFF	FFFF	FFFF	FFFF	FFFF	FFFF
	Char.																
E1E0	BIG5	FFFF	FFFF	FFFF	FFFF	FFFF	FFFF	FFFF	FFFF	FFFF	FFFF	FFFF	FFFF	FFFF	FFFF	FFFF	FFFF
	Char.																
E1F0	BIG5	FFFF	FFFF	FFFF	FFFF	FFFF	FFFF	FFFF	FFFF	FFFF	FFFF	FFFF	FFFF	FFFF	FFFF		
	Char.																
E240	BIG5		FFFF	FFFF	FFFF	FFFF	FFFF	FFFF	FFFF	FFFF	FFFF	FFFF	FFFF	FFFF	FFFF	FFFF	FFFF
	Char.																
E250	BIG5	FFFF	FFFF	FFFF	FFFF	FFFF	FFFF	FFFF	FFFF	FFFF	FFFF	FFFF	FFFF	FFFF	FFFF	FFFF	FFFF
	Char.																
E260	BIG5	FFFF	FFFF	FFFF	FFFF	FFFF	FFFF	FFFF	FFFF	FFFF	FFFF	FFFF	FFFF	FFFF	FFFF	FFFF	FFFF
	Char.																

Table B-3 IBM à Big5 Conversion Table (continued)

IBM		+ 0	+ 1	+ 2	+ 3	+ 4	+ 5	+ 6	+ 7	+ 8	+ 9	+ A	+ B	+ C	+ D	+ E	+ F
E270	BIG5	FFFF	FFFF	FFFF	FFFF	FFFF	FFFF	FFFF	FFFF	FFFF	FFFF	FFFF	FFFF	FFFF	FFFF	FFFF	FFFF
	Char.																
E280	BIG5		FFFF	FFFF	FFFF	FFFF	FFFF	FFFF	FFFF	FFFF	FFFF	FFFF	FFFF	FFFF	FFFF	FFFF	FFFF
	Char.																
E290	BIG5	FFFF	FFFF	FFFF	FFFF	FFFF	FFFF	FFFF	FFFF	FFFF	FFFF	FFFF	FFFF	FFFF	FFFF	FFFF	FFFF
	Char.																
E2A0	BIG5	FFFF	FFFF	FFFF	FFFF	FFFF	FFFF	FFFF	FFFF	FFFF	FFFF	FFFF	FFFF	FFFF	FFFF	FFFF	FFFF
	Char.																
E2B0	BIG5	FFFF	FFFF	FFFF	FFFF	FFFF	FFFF	FFFF	FFFF	FFFF	FFFF	FFFF	FFFF	FFFF	FFFF	FFFF	FFFF
	Char.																
E2C0	BIG5	FFFF	FFFF	FFFF	FFFF	FFFF	FFFF	FFFF	FFFF	FFFF	FFFF	FFFF	FFFF	FFFF	FFFF	FFFF	FFFF
	Char.																
E2D0	BIG5	FFFF	FFFF	FFFF	FFFF	FFFF	FFFF	FFFF	FFFF	FFFF	FFFF	FFFF	FFFF	FFFF	FFFF	FFFF	FFFF
	Char.																
E2E0	BIG5	FFFF	FFFF	FFFF	FFFF	FFFF	FFFF	FFFF	FFFF	FFFF	FFFF	FFFF	FFFF	FFFF	FFFF	FFFF	FFFF
	Char.																
E2F0	BIG5	FFFF	FFFF	FFFF	FFFF	FFFF	FFFF	FFFF	FFFF	FFFF	FFFF	FFFF	FFFF	FFFF	FFFF		
	Char.																

Table B- 4 Big5 à IBM Conversion Table (continues on the following pages)

Big5		+ 0	+ 1	+ 2	+ 3	+ 4	+ 5	+ 6	+ 7	+ 8	+ 9	+ A	+ B	+ C	+ D	+ E	+ F
8140	IBM	FFFF	FFFF	FFFF	FFFF	FFFF	FFFF	FFFF	FFFF	FFFF	FFFF	FFFF	FFFF	FFFF	FFFF	FFFF	FFFF
	Char.																
8150	IBM	FFFF	FFFF	FFFF	FFFF	FFFF	FFFF	FFFF	FFFF	FFFF	FFFF	FFFF	FFFF	FFFF	FFFF	FFFF	FFFF
	Char.																
8160	IBM	FFFF	FFFF	FFFF	FFFF	FFFF	FFFF	FFFF	FFFF	FFFF	FFFF	FFFF	FFFF	FFFF	FFFF	FFFF	FFFF
	Char.																
8170	IBM	FFFF	FFFF	FFFF	FFFF	FFFF	FFFF	FFFF	FFFF	FFFF	FFFF	FFFF	FFFF	FFFF	FFFF	FFFF	FFFF
	Char.																
81A0	IBM		FFFF	FFFF	FFFF	FFFF	FFFF	FFFF	FFFF	FFFF	FFFF	FFFF	FFFF	FFFF	FFFF	FFFF	FFFF
	Char.																
81B0	IBM	FFFF	FFFF	FFFF	FFFF	FFFF	FFFF	FFFF	FFFF	FFFF	FFFF	FFFF	FFFF	FFFF	FFFF	FFFF	FFFF
	Char.																
81C0	IBM	FFFF	FFFF	FFFF	FFFF	FFFF	FFFF	FFFF	FFFF	FFFF	FFFF	FFFF	FFFF	FFFF	FFFF	FFFF	FFFF
	Char.																
81D0	IBM	FFFF	FFFF	FFFF	FFFF	FFFF	FFFF	FFFF	FFFF	FFFF	FFFF	FFFF	FFFF	FFFF	FFFF	FFFF	FFFF
	Char.																
81E0	IBM	FFFF	FFFF	FFFF	FFFF	FFFF	FFFF	FFFF	FFFF	FFFF	FFFF	FFFF	FFFF	FFFF	FFFF	FFFF	FFFF
	Char.																
81F0	IBM	FFFF	FFFF	FFFF	FFFF	FFFF	FFFF	FFFF	FFFF	FFFF	FFFF	FFFF	FFFF	FFFF	FFFF	FFFF	FFFF
	Char.																
8240	IBM	FFFF	FFFF	FFFF	FFFF	FFFF	FFFF	FFFF	FFFF	FFFF	FFFF	FFFF	FFFF	FFFF	FFFF	FFFF	FFFF
	Char.																
8250	IBM	FFFF	FFFF	FFFF	FFFF	FFFF	FFFF	FFFF	FFFF	FFFF	FFFF	FFFF	FFFF	FFFF	FFFF	FFFF	FFFF
	Char.																

Table B-4 Big5 à IBM Conversion Table (continued)

Big5		+ 0	+ 1	+ 2	+ 3	+ 4	+ 5	+ 6	+ 7	+ 8	+ 9	+ A	+ B	+ C	+ D	+ E	+ F
8260	IBM	FFFF	FFFF	FFFF	FFFF	FFFF	FFFF	FFFF	FFFF	FFFF	FFFF	FFFF	FFFF	FFFF	FFFF	FFFF	FFFF
	Char.																
8270	IBM	FFFF	FFFF	FFFF	FFFF	FFFF	FFFF	FFFF	FFFF	FFFF	FFFF	FFFF	FFFF	FFFF	FFFF	FFFF	
	Char.																
82A0	IBM		FFFF	FFFF	FFFF	FFFF	FFFF	FFFF	FFFF	FFFF	FFFF	FFFF	FFFF	FFFF	FFFF	FFFF	FFFF
	Char.																
82B0	IBM	FFFF	FFFF	FFFF	FFFF	FFFF	FFFF	FFFF	FFFF	FFFF	FFFF	FFFF	FFFF	FFFF	FFFF	FFFF	FFFF
	Char.																
82C0	IBM	FFFF	FFFF	FFFF	FFFF	FFFF	FFFF	FFFF	FFFF	FFFF	FFFF	FFFF	FFFF	FFFF	FFFF	FFFF	FFFF
	Char.																
82D0	IBM	FFFF	FFFF	FFFF	FFFF	FFFF	FFFF	FFFF	FFFF	FFFF	FFFF	FFFF	FFFF	FFFF	FFFF	FFFF	FFFF
	Char.																
82E0	IBM	FFFF	FFFF	FFFF	FFFF	FFFF	FFFF	FFFF	FFFF	FFFF	FFFF	FFFF	FFFF	FFFF	FFFF	FFFF	FFFF
	Char.																
82F0	IBM	FFFF	FFFF	FFFF	FFFF	FFFF	FFFF	FFFF	FFFF	FFFF	FFFF	FFFF	FFFF	FFFF	FFFF	FFFF	
	Char.																
8340	IBM	FFFF	FFFF	FFFF	FFFF	FFFF	FFFF	FFFF	FFFF	FFFF	FFFF	FFFF	FFFF	FFFF	FFFF	FFFF	FFFF
	Char.																
8350	IBM	FFFF	FFFF	FFFF	FFFF	FFFF	FFFF	FFFF	FFFF	FFFF	FFFF	FFFF	FFFF	FFFF	FFFF	FFFF	FFFF
	Char.																
8360	IBM	FFFF	FFFF	FFFF	FFFF	FFFF	FFFF	FFFF	FFFF	FFFF	FFFF	FFFF	FFFF	FFFF	FFFF	FFFF	FFFF
	Char.																
8370	IBM	FFFF	FFFF	FFFF	FFFF	FFFF	FFFF	FFFF	FFFF	FFFF	FFFF	FFFF	FFFF	FFFF	FFFF	FFFF	
	Char.																

Table B-4 Big5 à IBM Conversion Table (continued)

Big5		+ 0	+ 1	+ 2	+ 3	+ 4	+ 5	+ 6	+ 7	+ 8	+ 9	+ A	+ B	+ C	+ D	+ E	+ F
83A0	IBM		FFFF	FFFF	FFFF	FFFF	FFFF	FFFF	FFFF	FFFF	FFFF	FFFF	FFFF	FFFF	FFFF	FFFF	FFFF
	Char.																
83B0	IBM	FFFF	FFFF	FFFF	FFFF	FFFF	FFFF	FFFF	FFFF	FFFF	FFFF	FFFF	FFFF	FFFF	FFFF	FFFF	FFFF
	Char.																
83C0	IBM	FFFF	FFFF	FFFF	FFFF	FFFF	FFFF	FFFF	FFFF	FFFF	FFFF	FFFF	FFFF	FFFF	FFFF	FFFF	FFFF
	Char.																
83D0	IBM	FFFF	FFFF	FFFF	FFFF	FFFF	FFFF	FFFF	FFFF	FFFF	FFFF	FFFF	FFFF	FFFF	FFFF	FFFF	FFFF
	Char.																
83E0	IBM	FFFF	FFFF	FFFF	FFFF	FFFF	FFFF	FFFF	FFFF	FFFF	FFFF	FFFF	FFFF	FFFF	FFFF	FFFF	FFFF
	Char.																
83F0	IBM	FFFF	FFFF	FFFF	FFFF	FFFF	FFFF	FFFF	FFFF	FFFF	FFFF	FFFF	FFFF	FFFF	FFFF	FFFF	FFFF
	Char.																
8440	IBM	FFFF	FFFF	FFFF	FFFF	FFFF	FFFF	FFFF	FFFF	FFFF	FFFF	FFFF	FFFF	FFFF	FFFF	FFFF	FFFF
	Char.																
8450	IBM	FFFF	FFFF	FFFF	FFFF	FFFF	FFFF	FFFF	FFFF	FFFF	FFFF	FFFF	FFFF	FFFF	FFFF	FFFF	FFFF
	Char.																
8460	IBM	FFFF	FFFF	FFFF	FFFF	FFFF	FFFF	FFFF	FFFF	FFFF	FFFF	FFFF	FFFF	FFFF	FFFF	FFFF	FFFF
	Char.																
8470	IBM	FFFF	FFFF	FFFF	FFFF	FFFF	FFFF	FFFF	FFFF	FFFF	FFFF	FFFF	FFFF	FFFF	FFFF	FFFF	FFFF
	Char.																
84A0	IBM		FFFF	FFFF	FFFF	FFFF	FFFF	FFFF	FFFF	FFFF	FFFF	FFFF	FFFF	FFFF	FFFF	FFFF	FFFF
	Char.																
84B0	IBM	FFFF	FFFF	FFFF	FFFF	FFFF	FFFF	FFFF	FFFF	FFFF	FFFF	FFFF	FFFF	FFFF	FFFF	FFFF	FFFF
	Char.																

Table B-4 Big5 à IBM Conversion Table (continued)

Big5		+ 0	+ 1	+ 2	+ 3	+ 4	+ 5	+ 6	+ 7	+ 8	+ 9	+ A	+ B	+ C	+ D	+ E	+ F
84C0	IBM	FFFF	FFFF	FFFF	FFFF	FFFF	FFFF	FFFF	FFFF	FFFF	FFFF	FFFF	FFFF	FFFF	FFFF	FFFF	FFFF
	Char.																
84D0	IBM	FFFF	FFFF	FFFF	FFFF	FFFF	FFFF	FFFF	FFFF	FFFF	FFFF	FFFF	FFFF	FFFF	FFFF	FFFF	FFFF
	Char.																
84E0	IBM	FFFF	FFFF	FFFF	FFFF	FFFF	FFFF	FFFF	FFFF	FFFF	FFFF	FFFF	FFFF	FFFF	FFFF	FFFF	FFFF
	Char.																
84F0	IBM	FFFF	FFFF	FFFF	FFFF	FFFF	FFFF	FFFF	FFFF	FFFF	FFFF	FFFF	FFFF	FFFF	FFFF	FFFF	FFFF
	Char.																
8540	IBM	FFFF	FFFF	FFFF	FFFF	FFFF	FFFF	FFFF	FFFF	FFFF	FFFF	FFFF	FFFF	FFFF	FFFF	FFFF	FFFF
	Char.																
8550	IBM	FFFF	FFFF	FFFF	FFFF	FFFF	FFFF	FFFF	FFFF	FFFF	FFFF	FFFF	FFFF	FFFF	FFFF	FFFF	FFFF
	Char.																
8560	IBM	FFFF	FFFF	FFFF	FFFF	FFFF	FFFF	FFFF	FFFF	FFFF	FFFF	FFFF	FFFF	FFFF	FFFF	FFFF	FFFF
	Char.																
8570	IBM	FFFF	FFFF	FFFF	FFFF	FFFF	FFFF	FFFF	FFFF	FFFF	FFFF	FFFF	FFFF	FFFF	FFFF	FFFF	FFFF
	Char.																
85A0	IBM		FFFF	FFFF	FFFF	FFFF	FFFF	FFFF	FFFF	FFFF	FFFF	FFFF	FFFF	FFFF	FFFF	FFFF	FFFF
	Char.																
85B0	IBM	FFFF	FFFF	FFFF	FFFF	FFFF	FFFF	FFFF	FFFF	FFFF	FFFF	FFFF	FFFF	FFFF	FFFF	FFFF	FFFF
	Char.																
85C0	IBM	FFFF	FFFF	FFFF	FFFF	FFFF	FFFF	FFFF	FFFF	FFFF	FFFF	FFFF	FFFF	FFFF	FFFF	FFFF	FFFF
	Char.																
85D0	IBM	FFFF	FFFF	FFFF	FFFF	FFFF	FFFF	FFFF	FFFF	FFFF	FFFF	FFFF	FFFF	FFFF	FFFF	FFFF	FFFF
	Char.																

Table B-4 Big5 à IBM Conversion Table (continued)

Big5		+ 0	+ 1	+ 2	+ 3	+ 4	+ 5	+ 6	+ 7	+ 8	+ 9	+ A	+ B	+ C	+ D	+ E	+ F
85E0	IBM	FFFF	FFFF	FFFF	FFFF	FFFF	FFFF	FFFF	FFFF	FFFF	FFFF	FFFF	FFFF	FFFF	FFFF	FFFF	FFFF
	Char.																
85F0	IBM	FFFF	FFFF	FFFF	FFFF	FFFF	FFFF	FFFF	FFFF	FFFF	FFFF	FFFF	FFFF	FFFF	FFFF	FFFF	FFFF
	Char.																
8640	IBM	FFFF	FFFF	FFFF	FFFF	FFFF	FFFF	FFFF	FFFF	FFFF	FFFF	FFFF	FFFF	FFFF	FFFF	FFFF	FFFF
	Char.																
8650	IBM	FFFF	FFFF	FFFF	FFFF	FFFF	FFFF	FFFF	FFFF	FFFF	FFFF	FFFF	FFFF	FFFF	FFFF	FFFF	FFFF
	Char.																
8660	IBM	FFFF	FFFF	FFFF	FFFF	FFFF	FFFF	FFFF	FFFF	FFFF	FFFF	FFFF	FFFF	FFFF	FFFF	FFFF	FFFF
	Char.																
8670	IBM	FFFF	FFFF	FFFF	FFFF	FFFF	FFFF	FFFF	FFFF	FFFF	FFFF	FFFF	FFFF	FFFF	FFFF	FFFF	FFFF
	Char.																
86A0	IBM		FFFF	FFFF	FFFF	FFFF	FFFF	FFFF	FFFF	FFFF	FFFF	FFFF	FFFF	FFFF	FFFF	FFFF	FFFF
	Char.																
86B0	IBM	FFFF	FFFF	FFFF	FFFF	FFFF	FFFF	FFFF	FFFF	FFFF	FFFF	FFFF	FFFF	FFFF	FFFF	FFFF	FFFF
	Char.																
86C0	IBM	FFFF	FFFF	FFFF	FFFF	FFFF	FFFF	FFFF	FFFF	FFFF	FFFF	FFFF	FFFF	FFFF	FFFF	FFFF	FFFF
	Char.																
86D0	IBM	FFFF	FFFF	FFFF	FFFF	FFFF	FFFF	FFFF	FFFF	FFFF	FFFF	FFFF	FFFF	FFFF	FFFF	FFFF	FFFF
	Char.																
86E0	IBM	FFFF	FFFF	FFFF	FFFF	FFFF	FFFF	FFFF	FFFF	FFFF	FFFF	FFFF	FFFF	FFFF	FFFF	FFFF	FFFF
	Char.																

Table B-4 Big5 à IBM Conversion Table (continued)

Big5		+ 0	+ 1	+ 2	+ 3	+ 4	+ 5	+ 6	+ 7	+ 8	+ 9	+ A	+ B	+ C	+ D	+ E	+ F
86F0	IBM	FFFF	FFFF	FFFF	FFFF	FFFF	FFFF	FFFF	FFFF	FFFF	FFFF	FFFF	FFFF	FFFF	FFFF	FFFF	
	Char.																
8740	IBM	FFFF	FFFF	FFFF	FFFF	FFFF	FFFF	FFFF	FFFF	FFFF	FFFF	FFFF	FFFF	FFFF	FFFF	FFFF	FFFF
	Char.																
8750	IBM	FFFF	FFFF	FFFF	FFFF	FFFF	FFFF	FFFF	FFFF	FFFF	FFFF	FFFF	FFFF	FFFF	FFFF	FFFF	FFFF
	Char.																
8760	IBM	FFFF	FFFF	FFFF	FFFF	FFFF	FFFF	FFFF	FFFF	FFFF	FFFF	FFFF	FFFF	FFFF	FFFF	FFFF	FFFF
	Char.																
8770	IBM	FFFF	FFFF	FFFF	FFFF	FFFF	FFFF	FFFF	FFFF	FFFF	FFFF	FFFF	FFFF	FFFF	FFFF	FFFF	
	Char.																
87A0	IBM		FFFF	FFFF	FFFF	FFFF	FFFF	FFFF	FFFF	FFFF	FFFF	FFFF	FFFF	FFFF	FFFF	FFFF	FFFF
	Char.																
87B0	IBM	FFFF	FFFF	FFFF	FFFF	FFFF	FFFF	FFFF	FFFF	FFFF	FFFF	FFFF	FFFF	FFFF	FFFF	FFFF	FFFF
	Char.																
87C0	IBM	FFFF	FFFF	FFFF	FFFF	FFFF	FFFF	FFFF	FFFF	FFFF	FFFF	FFFF	FFFF	FFFF	FFFF	FFFF	FFFF
	Char.																
87D0	IBM	FFFF	FFFF	FFFF	FFFF	FFFF	FFFF	FFFF	FFFF	FFFF	FFFF	FFFF	FFFF	FFFF	FFFF	FFFF	FFFF
	Char.																
87E0	IBM	FFFF	FFFF	FFFF	FFFF	FFFF	FFFF	FFFF	FFFF	FFFF	FFFF	FFFF	FFFF	FFFF	FFFF	FFFF	FFFF
	Char.																
87F0	IBM	FFFF	FFFF	FFFF	FFFF	FFFF	FFFF	FFFF	FFFF	FFFF	FFFF	FFFF	FFFF	FFFF	FFFF	FFFF	
	Char.																
8840	IBM	FFFF	FFFF	FFFF	FFFF	FFFF	FFFF	FFFF	FFFF	FFFF	FFFF	FFFF	FFFF	FFFF	FFFF	FFFF	FFFF
	Char.																

Table B-4 Big5 à IBM Conversion Table (continued)

Big5		+ 0	+ 1	+ 2	+ 3	+ 4	+ 5	+ 6	+ 7	+ 8	+ 9	+ A	+ B	+ C	+ D	+ E	+ F
8850	IBM	FFFF	FFFF	FFFF	FFFF	FFFF	FFFF	FFFF	FFFF	FFFF	FFFF	FFFF	FFFF	FFFF	FFFF	FFFF	FFFF
	Char.																
8860	IBM	FFFF	FFFF	FFFF	FFFF	FFFF	FFFF	FFFF	FFFF	FFFF	FFFF	FFFF	FFFF	FFFF	FFFF	FFFF	FFFF
	Char.																
8870	IBM	FFFF	FFFF	FFFF	FFFF	FFFF	FFFF	FFFF	FFFF	FFFF	FFFF	FFFF	FFFF	FFFF	FFFF	FFFF	
	Char.																
88A0	IBM		FFFF	FFFF	FFFF	FFFF	FFFF	FFFF	FFFF	FFFF	FFFF	FFFF	FFFF	FFFF	FFFF	FFFF	FFFF
	Char.																
88B0	IBM	FFFF	FFFF	FFFF	FFFF	FFFF	FFFF	FFFF	FFFF	FFFF	FFFF	FFFF	FFFF	FFFF	FFFF	FFFF	FFFF
	Char.																
88C0	IBM	FFFF	FFFF	FFFF	FFFF	FFFF	FFFF	FFFF	FFFF	FFFF	FFFF	FFFF	FFFF	FFFF	FFFF	FFFF	FFFF
	Char.																
88D0	IBM	FFFF	FFFF	FFFF	FFFF	FFFF	FFFF	FFFF	FFFF	FFFF	FFFF	FFFF	FFFF	FFFF	FFFF	FFFF	FFFF
	Char.																
88E0	IBM	FFFF	FFFF	FFFF	FFFF	FFFF	FFFF	FFFF	FFFF	FFFF	FFFF	FFFF	FFFF	FFFF	FFFF	FFFF	FFFF
	Char.																
88F0	IBM	FFFF	FFFF	FFFF	FFFF	FFFF	FFFF	FFFF	FFFF	FFFF	FFFF	FFFF	FFFF	FFFF	FFFF	FFFF	
	Char.																
8940	IBM	FFFF	FFFF	FFFF	FFFF	FFFF	FFFF	FFFF	FFFF	FFFF	FFFF	FFFF	FFFF	FFFF	FFFF	FFFF	FFFF
	Char.																
8950	IBM	FFFF	FFFF	FFFF	FFFF	FFFF	FFFF	FFFF	FFFF	FFFF	FFFF	FFFF	FFFF	FFFF	FFFF	FFFF	FFFF
	Char.																
8960	IBM	FFFF	FFFF	FFFF	FFFF	FFFF	FFFF	FFFF	FFFF	FFFF	FFFF	FFFF	FFFF	FFFF	FFFF	FFFF	FFFF
	Char.																

Table B-4 Big5 à IBM Conversion Table (continued)

Big5		+ 0	+ 1	+ 2	+ 3	+ 4	+ 5	+ 6	+ 7	+ 8	+ 9	+ A	+ B	+ C	+ D	+ E	+ F
8970	IBM	FFFF	FFFF	FFFF	FFFF	FFFF	FFFF	FFFF	FFFF	FFFF	FFFF	FFFF	FFFF	FFFF	FFFF	FFFF	
	Char.																
89A0	IBM		FFFF	FFFF	FFFF	FFFF	FFFF	FFFF	FFFF	FFFF	FFFF	FFFF	FFFF	FFFF	FFFF	FFFF	FFFF
	Char.																
89B0	IBM	FFFF	FFFF	FFFF	FFFF	FFFF	FFFF	FFFF	FFFF	FFFF	FFFF	FFFF	FFFF	FFFF	FFFF	FFFF	FFFF
	Char.																
89C0	IBM	FFFF	FFFF	FFFF	FFFF	FFFF	FFFF	FFFF	FFFF	FFFF	FFFF	FFFF	FFFF	FFFF	FFFF	FFFF	FFFF
	Char.																
89D0	IBM	FFFF	FFFF	FFFF	FFFF	FFFF	FFFF	FFFF	FFFF	FFFF	FFFF	FFFF	FFFF	FFFF	FFFF	FFFF	FFFF
	Char.																
89E0	IBM	FFFF	FFFF	FFFF	FFFF	FFFF	FFFF	FFFF	FFFF	FFFF	FFFF	FFFF	FFFF	FFFF	FFFF	FFFF	FFFF
	Char.																
89F0	IBM	FFFF	FFFF	FFFF	FFFF	FFFF	FFFF	FFFF	FFFF	FFFF	FFFF	FFFF	FFFF	FFFF	FFFF	FFFF	
	Char.																
8A40	IBM	FFFF	FFFF	FFFF	FFFF	FFFF	FFFF	FFFF	FFFF	FFFF	FFFF	FFFF	FFFF	FFFF	FFFF	FFFF	FFFF
	Char.																
8A50	IBM	FFFF	FFFF	FFFF	FFFF	FFFF	FFFF	FFFF	FFFF	FFFF	FFFF	FFFF	FFFF	FFFF	FFFF	FFFF	FFFF
	Char.																
8A60	IBM	FFFF	FFFF	FFFF	FFFF	FFFF	FFFF	FFFF	FFFF	FFFF	FFFF	FFFF	FFFF	FFFF	FFFF	FFFF	FFFF
	Char.																
8A70	IBM	FFFF	FFFF	FFFF	FFFF	FFFF	FFFF	FFFF	FFFF	FFFF	FFFF	FFFF	FFFF	FFFF	FFFF	FFFF	
	Char.																
8AA0	IBM		FFFF	FFFF	FFFF	FFFF	FFFF	FFFF	FFFF	FFFF	FFFF	FFFF	FFFF	FFFF	FFFF	FFFF	FFFF
	Char.																

Table B-4 Big5 à IBM Conversion Table (continued)

Big5		+ 0	+ 1	+ 2	+ 3	+ 4	+ 5	+ 6	+ 7	+ 8	+ 9	+ A	+ B	+ C	+ D	+ E	+ F
8AB0	IBM	FFFF	FFFF	FFFF	FFFF	FFFF	FFFF	FFFF	FFFF	FFFF	FFFF	FFFF	FFFF	FFFF	FFFF	FFFF	FFFF
	Char.																
8AC0	IBM	FFFF	FFFF	FFFF	FFFF	FFFF	FFFF	FFFF	FFFF	FFFF	FFFF	FFFF	FFFF	FFFF	FFFF	FFFF	FFFF
	Char.																
8AD0	IBM	FFFF	FFFF	FFFF	FFFF	FFFF	FFFF	FFFF	FFFF	FFFF	FFFF	FFFF	FFFF	FFFF	FFFF	FFFF	FFFF
	Char.																
8AE0	IBM	FFFF	FFFF	FFFF	FFFF	FFFF	FFFF	FFFF	FFFF	FFFF	FFFF	FFFF	FFFF	FFFF	FFFF	FFFF	FFFF
	Char.																
8AF0	IBM	FFFF	FFFF	FFFF	FFFF	FFFF	FFFF	FFFF	FFFF	FFFF	FFFF	FFFF	FFFF	FFFF	FFFF	FFFF	FFFF
	Char.																
8B40	IBM	FFFF	FFFF	FFFF	FFFF	FFFF	FFFF	FFFF	FFFF	FFFF	FFFF	FFFF	FFFF	FFFF	FFFF	FFFF	FFFF
	Char.																
8B50	IBM	FFFF	FFFF	FFFF	FFFF	FFFF	FFFF	FFFF	FFFF	FFFF	FFFF	FFFF	FFFF	FFFF	FFFF	FFFF	FFFF
	Char.																
8B60	IBM	FFFF	FFFF	FFFF	FFFF	FFFF	FFFF	FFFF	FFFF	FFFF	FFFF	FFFF	FFFF	FFFF	FFFF	FFFF	FFFF
	Char.																
8B70	IBM	FFFF	FFFF	FFFF	FFFF	FFFF	FFFF	FFFF	FFFF	FFFF	FFFF	FFFF	FFFF	FFFF	FFFF	FFFF	FFFF
	Char.																
8BA0	IBM		FFFF	FFFF	FFFF	FFFF	FFFF	FFFF	FFFF	FFFF	FFFF	FFFF	FFFF	FFFF	FFFF	FFFF	FFFF
	Char.																
8BB0	IBM	FFFF	FFFF	FFFF	FFFF	FFFF	FFFF	FFFF	FFFF	FFFF	FFFF	FFFF	FFFF	FFFF	FFFF	FFFF	FFFF
	Char.																

Table B-4 Big5 à IBM Conversion Table (continued)

Big5		+ 0	+ 1	+ 2	+ 3	+ 4	+ 5	+ 6	+ 7	+ 8	+ 9	+ A	+ B	+ C	+ D	+ E	+ F
8BC0	IBM	FFFF	FFFF	FFFF	FFFF	FFFF	FFFF	FFFF	FFFF	FFFF	FFFF	FFFF	FFFF	FFFF	FFFF	FFFF	FFFF
	Char.																
8BD0	IBM	FFFF	FFFF	FFFF	FFFF	FFFF	FFFF	FFFF	FFFF	FFFF	FFFF	FFFF	FFFF	FFFF	FFFF	FFFF	FFFF
	Char.																
8BE0	IBM	FFFF	FFFF	FFFF	FFFF	FFFF	FFFF	FFFF	FFFF	FFFF	FFFF	FFFF	FFFF	FFFF	FFFF	FFFF	FFFF
	Char.																
8BF0	IBM	FFFF	FFFF	FFFF	FFFF	FFFF	FFFF	FFFF	FFFF	FFFF	FFFF	FFFF	FFFF	FFFF	FFFF	FFFF	FFFF
	Char.																
8C40	IBM	FFFF	FFFF	FFFF	FFFF	FFFF	FFFF	FFFF	FFFF	FFFF	FFFF	FFFF	FFFF	FFFF	FFFF	FFFF	FFFF
	Char.																
8C50	IBM	FFFF	FFFF	FFFF	FFFF	FFFF	FFFF	FFFF	FFFF	FFFF	FFFF	FFFF	FFFF	FFFF	FFFF	FFFF	FFFF
	Char.																
8C60	IBM	FFFF	FFFF	FFFF	FFFF	FFFF	FFFF	FFFF	FFFF	FFFF	FFFF	FFFF	FFFF	FFFF	FFFF	FFFF	FFFF
	Char.																
8C70	IBM	FFFF	FFFF	FFFF	FFFF	FFFF	FFFF	FFFF	FFFF	FFFF	FFFF	FFFF	FFFF	FFFF	FFFF	FFFF	FFFF
	Char.																
8CA0	IBM		FFFF	FFFF	FFFF	FFFF	FFFF	FFFF	FFFF	FFFF	FFFF	FFFF	FFFF	FFFF	FFFF	FFFF	FFFF
	Char.																
8CB0	IBM	FFFF	FFFF	FFFF	FFFF	FFFF	FFFF	FFFF	FFFF	FFFF	FFFF	FFFF	FFFF	FFFF	FFFF	FFFF	FFFF
	Char.																
8CC0	IBM	FFFF	FFFF	FFFF	FFFF	FFFF	FFFF	FFFF	FFFF	FFFF	FFFF	FFFF	FFFF	FFFF	FFFF	FFFF	FFFF
	Char.																
8CD0	IBM	FFFF	FFFF	FFFF	FFFF	FFFF	FFFF	FFFF	FFFF	FFFF	FFFF	FFFF	FFFF	FFFF	FFFF	FFFF	FFFF
	Char.																

Table B-4 Big5 à IBM Conversion Table (continued)

Big5		+ 0	+ 1	+ 2	+ 3	+ 4	+ 5	+ 6	+ 7	+ 8	+ 9	+ A	+ B	+ C	+ D	+ E	+ F
8CE0	IBM	FFFF	FFFF	FFFF	FFFF	FFFF	FFFF	FFFF	FFFF	FFFF	FFFF	FFFF	FFFF	FFFF	FFFF	FFFF	FFFF
	Char.																
8CF0	IBM	FFFF	FFFF	FFFF	FFFF	FFFF	FFFF	FFFF	FFFF	FFFF	FFFF	FFFF	FFFF	FFFF	FFFF	FFFF	FFFF
	Char.																
8D40	IBM	FFFF	FFFF	FFFF	FFFF	FFFF	FFFF	FFFF	FFFF	FFFF	FFFF	FFFF	FFFF	FFFF	FFFF	FFFF	FFFF
	Char.																
8D50	IBM	FFFF	FFFF	FFFF	FFFF	FFFF	FFFF	FFFF	FFFF	FFFF	FFFF	FFFF	FFFF	FFFF	FFFF	FFFF	FFFF
	Char.																
8D60	IBM	FFFF	FFFF	FFFF	FFFF	FFFF	FFFF	FFFF	FFFF	FFFF	FFFF	FFFF	FFFF	FFFF	FFFF	FFFF	FFFF
	Char.																
8D70	IBM	FFFF	FFFF	FFFF	FFFF	FFFF	FFFF	FFFF	FFFF	FFFF	FFFF	FFFF	FFFF	FFFF	FFFF	FFFF	FFFF
	Char.																
8DA0	IBM		FFFF	FFFF	FFFF	FFFF	FFFF	FFFF	FFFF	FFFF	FFFF	FFFF	FFFF	FFFF	FFFF	FFFF	FFFF
	Char.																
8DB0	IBM	FFFF	FFFF	FFFF	FFFF	FFFF	FFFF	FFFF	FFFF	FFFF	FFFF	FFFF	FFFF	FFFF	FFFF	FFFF	FFFF
	Char.																
8DC0	IBM	FFFF	FFFF	FFFF	FFFF	FFFF	FFFF	FFFF	FFFF	FFFF	FFFF	FFFF	FFFF	FFFF	FFFF	FFFF	FFFF
	Char.																
8DD0	IBM	FFFF	FFFF	FFFF	FFFF	FFFF	FFFF	FFFF	FFFF	FFFF	FFFF	FFFF	FFFF	FFFF	FFFF	FFFF	FFFF
	Char.																
8DE0	IBM	FFFF	FFFF	FFFF	FFFF	FFFF	FFFF	FFFF	FFFF	FFFF	FFFF	FFFF	FFFF	FFFF	FFFF	FFFF	FFFF
	Char.																
8DF0	IBM	FFFF	FFFF	FFFF	FFFF	FFFF	FFFF	FFFF	FFFF	FFFF	FFFF	FFFF	FFFF	FFFF	FFFF	FFFF	FFFF
	Char.																

Table B-4 Big5 à IBM Conversion Table (continued)

Big5		+ 0	+ 1	+ 2	+ 3	+ 4	+ 5	+ 6	+ 7	+ 8	+ 9	+ A	+ B	+ C	+ D	+ E	+ F
8E40	IBM	FFFF	FFFF	FFFF	FFFF	FFFF	FFFF	FFFF	FFFF	FFFF	FFFF	FFFF	FFFF	FFFF	FFFF	FFFF	FFFF
	Char.																
8E50	IBM	FFFF	FFFF	FFFF	FFFF	FFFF	FFFF	FFFF	FFFF	FFFF	FFFF	FFFF	FFFF	FFFF	FFFF	FFFF	FFFF
	Char.																
8E60	IBM	FFFF	FFFF	FFFF	FFFF	FFFF	FFFF	FFFF	FFFF	FFFF	FFFF	FFFF	FFFF	FFFF	FFFF	FFFF	FFFF
	Char.																
8E70	IBM	FFFF	FFFF	FFFF	FFFF	FFFF	FFFF	FFFF	FFFF	FFFF	FFFF	FFFF	FFFF	FFFF	FFFF	FFFF	FFFF
	Char.																
8EA0	IBM		FFFF	FFFF	FFFF	FFFF	FFFF	FFFF	FFFF	FFFF	FFFF	FFFF	FFFF	FFFF	FFFF	FFFF	FFFF
	Char.																
8EB0	IBM	FFFF	FFFF	FFFF	FFFF	FFFF	FFFF	FFFF	FFFF	FFFF	FFFF	FFFF	FFFF	FFFF	FFFF	FFFF	FFFF
	Char.																
8EC0	IBM	FFFF	FFFF	FFFF	FFFF	FFFF	FFFF	FFFF	FFFF	FFFF	FFFF	FFFF	FFFF	FFFF	FFFF	FFFF	FFFF
	Char.																
8ED0	IBM	FFFF	FFFF	FFFF	FFFF	FFFF	FFFF	FFFF	FFFF	FFFF	FFFF	FFFF	FFFF	FFFF	FFFF	FFFF	FFFF
	Char.																
8EE0	IBM	FFFF	FFFF	FFFF	FFFF	FFFF	FFFF	FFFF	FFFF	FFFF	FFFF	FFFF	FFFF	FFFF	FFFF	FFFF	FFFF
	Char.																
8EF0	IBM	FFFF	FFFF	FFFF	FFFF	FFFF	FFFF	FFFF	FFFF	FFFF	FFFF	FFFF	FFFF	FFFF	FFFF	FFFF	FFFF
	Char.																
8F40	IBM	FFFF	FFFF	FFFF	FFFF	FFFF	FFFF	FFFF	FFFF	FFFF	FFFF	FFFF	FFFF	FFFF	FFFF	FFFF	FFFF
	Char.																
8F50	IBM	FFFF	FFFF	FFFF	FFFF	FFFF	FFFF	FFFF	FFFF	FFFF	FFFF	FFFF	FFFF	FFFF	FFFF	FFFF	FFFF
	Char.																

Table B-4 Big5 à IBM Conversion Table (continued)

Big5		+ 0	+ 1	+ 2	+ 3	+ 4	+ 5	+ 6	+ 7	+ 8	+ 9	+ A	+ B	+ C	+ D	+ E	+ F
8F60	IBM	FFFF	FFFF	FFFF	FFFF	FFFF	FFFF	FFFF	FFFF	FFFF	FFFF	FFFF	FFFF	FFFF	FFFF	FFFF	FFFF
	Char.																
8F70	IBM	FFFF	FFFF	FFFF	FFFF	FFFF	FFFF	FFFF	FFFF	FFFF	FFFF	FFFF	FFFF	FFFF	FFFF	FFFF	
	Char.																
8FA0	IBM		FFFF	FFFF	FFFF	FFFF	FFFF	FFFF	FFFF	FFFF	FFFF	FFFF	FFFF	FFFF	FFFF	FFFF	FFFF
	Char.																
8FB0	IBM	FFFF	FFFF	FFFF	FFFF	FFFF	FFFF	FFFF	FFFF	FFFF	FFFF	FFFF	FFFF	FFFF	FFFF	FFFF	FFFF
	Char.																
8FC0	IBM	FFFF	FFFF	FFFF	FFFF	FFFF	FFFF	FFFF	FFFF	FFFF	FFFF	FFFF	FFFF	FFFF	FFFF	FFFF	FFFF
	Char.																
8FD0	IBM	FFFF	FFFF	FFFF	FFFF	FFFF	FFFF	FFFF	FFFF	FFFF	FFFF	FFFF	FFFF	FFFF	FFFF	FFFF	FFFF
	Char.																
8FE0	IBM	FFFF	FFFF	FFFF	FFFF	FFFF	FFFF	FFFF	FFFF	FFFF	FFFF	FFFF	FFFF	FFFF	FFFF	FFFF	FFFF
	Char.																
8FF0	IBM	FFFF	FFFF	FFFF	FFFF	FFFF	FFFF	FFFF	FFFF	FFFF	FFFF	FFFF	FFFF	FFFF	FFFF	FFFF	
	Char.																
9040	IBM	FFFF	FFFF	FFFF	FFFF	FFFF	FFFF	FFFF	FFFF	FFFF	FFFF	FFFF	FFFF	FFFF	FFFF	FFFF	FFFF
	Char.																
9050	IBM	FFFF	FFFF	FFFF	FFFF	FFFF	FFFF	FFFF	FFFF	FFFF	FFFF	FFFF	FFFF	FFFF	FFFF	FFFF	FFFF
	Char.																
9060	IBM	FFFF	FFFF	FFFF	FFFF	FFFF	FFFF	FFFF	FFFF	FFFF	FFFF	FFFF	FFFF	FFFF	FFFF	FFFF	FFFF
	Char.																
9070	IBM	FFFF	FFFF	FFFF	FFFF	FFFF	FFFF	FFFF	FFFF	FFFF	FFFF	FFFF	FFFF	FFFF	FFFF	FFFF	
	Char.																

Table B-4 Big5 à IBM Conversion Table (continued)

Big5		+ 0	+ 1	+ 2	+ 3	+ 4	+ 5	+ 6	+ 7	+ 8	+ 9	+ A	+ B	+ C	+ D	+ E	+ F
90A0	IBM		FFFF	FFFF	FFFF	FFFF	FFFF	FFFF	FFFF	FFFF	FFFF	FFFF	FFFF	FFFF	FFFF	FFFF	FFFF
	Char.																
90B0	IBM	FFFF	FFFF	FFFF	FFFF	FFFF	FFFF	FFFF	FFFF	FFFF	FFFF	FFFF	FFFF	FFFF	FFFF	FFFF	FFFF
	Char.																
90C0	IBM	FFFF	FFFF	FFFF	FFFF	FFFF	FFFF	FFFF	FFFF	FFFF	FFFF	FFFF	FFFF	FFFF	FFFF	FFFF	FFFF
	Char.																
90D0	IBM	FFFF	FFFF	FFFF	FFFF	FFFF	FFFF	FFFF	FFFF	FFFF	FFFF	FFFF	FFFF	FFFF	FFFF	FFFF	FFFF
	Char.																
90E0	IBM	FFFF	FFFF	FFFF	FFFF	FFFF	FFFF	FFFF	FFFF	FFFF	FFFF	FFFF	FFFF	FFFF	FFFF	FFFF	FFFF
	Char.																
90F0	IBM	FFFF	FFFF	FFFF	FFFF	FFFF	FFFF	FFFF	FFFF	FFFF	FFFF	FFFF	FFFF	FFFF	FFFF	FFFF	FFFF
	Char.																
9140	IBM	FFFF	FFFF	FFFF	FFFF	FFFF	FFFF	FFFF	FFFF	FFFF	FFFF	FFFF	FFFF	FFFF	FFFF	FFFF	FFFF
	Char.																
9150	IBM	FFFF	FFFF	FFFF	FFFF	FFFF	FFFF	FFFF	FFFF	FFFF	FFFF	FFFF	FFFF	FFFF	FFFF	FFFF	FFFF
	Char.																
9160	IBM	FFFF	FFFF	FFFF	FFFF	FFFF	FFFF	FFFF	FFFF	FFFF	FFFF	FFFF	FFFF	FFFF	FFFF	FFFF	FFFF
	Char.																
9170	IBM	FFFF	FFFF	FFFF	FFFF	FFFF	FFFF	FFFF	FFFF	FFFF	FFFF	FFFF	FFFF	FFFF	FFFF	FFFF	FFFF
	Char.																
91A0	IBM		FFFF	FFFF	FFFF	FFFF	FFFF	FFFF	FFFF	FFFF	FFFF	FFFF	FFFF	FFFF	FFFF	FFFF	FFFF
	Char.																

Table B-4 Big5 à IBM Conversion Table (continued)

Big5		+ 0	+ 1	+ 2	+ 3	+ 4	+ 5	+ 6	+ 7	+ 8	+ 9	+ A	+ B	+ C	+ D	+ E	+ F
91B0	IBM	FFFF	FFFF	FFFF	FFFF	FFFF	FFFF	FFFF	FFFF	FFFF	FFFF	FFFF	FFFF	FFFF	FFFF	FFFF	FFFF
	Char.																
91C0	IBM	FFFF	FFFF	FFFF	FFFF	FFFF	FFFF	FFFF	FFFF	FFFF	FFFF	FFFF	FFFF	FFFF	FFFF	FFFF	FFFF
	Char.																
91D0	IBM	FFFF	FFFF	FFFF	FFFF	FFFF	FFFF	FFFF	FFFF	FFFF	FFFF	FFFF	FFFF	FFFF	FFFF	FFFF	FFFF
	Char.																
91E0	IBM	FFFF	FFFF	FFFF	FFFF	FFFF	FFFF	FFFF	FFFF	FFFF	FFFF	FFFF	FFFF	FFFF	FFFF	FFFF	FFFF
	Char.																
91F0	IBM	FFFF	FFFF	FFFF	FFFF	FFFF	FFFF	FFFF	FFFF	FFFF	FFFF	FFFF	FFFF	FFFF	FFFF	FFFF	FFFF
	Char.																
9240	IBM	FFFF	FFFF	FFFF	FFFF	FFFF	FFFF	FFFF	FFFF	FFFF	FFFF	FFFF	FFFF	FFFF	FFFF	FFFF	FFFF
	Char.																
9250	IBM	FFFF	FFFF	FFFF	FFFF	FFFF	FFFF	FFFF	FFFF	FFFF	FFFF	FFFF	FFFF	FFFF	FFFF	FFFF	FFFF
	Char.																
9260	IBM	FFFF	FFFF	FFFF	FFFF	FFFF	FFFF	FFFF	FFFF	FFFF	FFFF	FFFF	FFFF	FFFF	FFFF	FFFF	FFFF
	Char.																
9270	IBM	FFFF	FFFF	FFFF	FFFF	FFFF	FFFF	FFFF	FFFF	FFFF	FFFF	FFFF	FFFF	FFFF	FFFF	FFFF	FFFF
	Char.																
92A0	IBM		FFFF	FFFF	FFFF	FFFF	FFFF	FFFF	FFFF	FFFF	FFFF	FFFF	FFFF	FFFF	FFFF	FFFF	FFFF
	Char.																
92B0	IBM	FFFF	FFFF	FFFF	FFFF	FFFF	FFFF	FFFF	FFFF	FFFF	FFFF	FFFF	FFFF	FFFF	FFFF	FFFF	FFFF
	Char.																
92C0	IBM	FFFF	FFFF	FFFF	FFFF	FFFF	FFFF	FFFF	FFFF	FFFF	FFFF	FFFF	FFFF	FFFF	FFFF	FFFF	FFFF
	Char.																

Table B-4 Big5 à IBM Conversion Table (continued)

Big5		+ 0	+ 1	+ 2	+ 3	+ 4	+ 5	+ 6	+ 7	+ 8	+ 9	+ A	+ B	+ C	+ D	+ E	+ F
92D0	IBM	FFFF	FFFF	FFFF	FFFF	FFFF	FFFF	FFFF	FFFF	FFFF	FFFF	FFFF	FFFF	FFFF	FFFF	FFFF	FFFF
	Char.																
92E0	IBM	FFFF	FFFF	FFFF	FFFF	FFFF	FFFF	FFFF	FFFF	FFFF	FFFF	FFFF	FFFF	FFFF	FFFF	FFFF	FFFF
	Char.																
92F0	IBM	FFFF	FFFF	FFFF	FFFF	FFFF	FFFF	FFFF	FFFF	FFFF	FFFF	FFFF	FFFF	FFFF	FFFF	FFFF	
	Char.																
9340	IBM	FFFF	FFFF	FFFF	FFFF	FFFF	FFFF	FFFF	FFFF	FFFF	FFFF	FFFF	FFFF	FFFF	FFFF	FFFF	FFFF
	Char.																
9350	IBM	FFFF	FFFF	FFFF	FFFF	FFFF	FFFF	FFFF	FFFF	FFFF	FFFF	FFFF	FFFF	FFFF	FFFF	FFFF	FFFF
	Char.																
9360	IBM	FFFF	FFFF	FFFF	FFFF	FFFF	FFFF	FFFF	FFFF	FFFF	FFFF	FFFF	FFFF	FFFF	FFFF	FFFF	FFFF
	Char.																
9370	IBM	FFFF	FFFF	FFFF	FFFF	FFFF	FFFF	FFFF	FFFF	FFFF	FFFF	FFFF	FFFF	FFFF	FFFF	FFFF	
	Char.																
93A0	IBM		FFFF	FFFF	FFFF	FFFF	FFFF	FFFF	FFFF	FFFF	FFFF	FFFF	FFFF	FFFF	FFFF	FFFF	FFFF
	Char.																
93B0	IBM	FFFF	FFFF	FFFF	FFFF	FFFF	FFFF	FFFF	FFFF	FFFF	FFFF	FFFF	FFFF	FFFF	FFFF	FFFF	FFFF
	Char.																
93C0	IBM	FFFF	FFFF	FFFF	FFFF	FFFF	FFFF	FFFF	FFFF	FFFF	FFFF	FFFF	FFFF	FFFF	FFFF	FFFF	FFFF
	Char.																
93D0	IBM	FFFF	FFFF	FFFF	FFFF	FFFF	FFFF	FFFF	FFFF	FFFF	FFFF	FFFF	FFFF	FFFF	FFFF	FFFF	FFFF
	Char.																
93E0	IBM	FFFF	FFFF	FFFF	FFFF	FFFF	FFFF	FFFF	FFFF	FFFF	FFFF	FFFF	FFFF	FFFF	FFFF	FFFF	FFFF
	Char.																

Table B-4 Big5 à IBM Conversion Table (continued)

Big5		+ 0	+ 1	+ 2	+ 3	+ 4	+ 5	+ 6	+ 7	+ 8	+ 9	+ A	+ B	+ C	+ D	+ E	+ F
93F0	IBM	FFFF	FFFF	FFFF	FFFF	FFFF	FFFF	FFFF	FFFF	FFFF	FFFF	FFFF	FFFF	FFFF	FFFF	FFFF	
	Char.																
9440	IBM	FFFF	FFFF	FFFF	FFFF	FFFF	FFFF	FFFF	FFFF	FFFF	FFFF	FFFF	FFFF	FFFF	FFFF	FFFF	FFFF
	Char.																
9450	IBM	FFFF	FFFF	FFFF	FFFF	FFFF	FFFF	FFFF	FFFF	FFFF	FFFF	FFFF	FFFF	FFFF	FFFF	FFFF	FFFF
	Char.																
9460	IBM	FFFF	FFFF	FFFF	FFFF	FFFF	FFFF	FFFF	FFFF	FFFF	FFFF	FFFF	FFFF	FFFF	FFFF	FFFF	FFFF
	Char.																
9470	IBM	FFFF	FFFF	FFFF	FFFF	FFFF	FFFF	FFFF	FFFF	FFFF	FFFF	FFFF	FFFF	FFFF	FFFF	FFFF	
	Char.																
94A0	IBM		FFFF	FFFF	FFFF	FFFF	FFFF	FFFF	FFFF	FFFF	FFFF	FFFF	FFFF	FFFF	FFFF	FFFF	FFFF
	Char.																
94B0	IBM	FFFF	FFFF	FFFF	FFFF	FFFF	FFFF	FFFF	FFFF	FFFF	FFFF	FFFF	FFFF	FFFF	FFFF	FFFF	FFFF
	Char.																
94C0	IBM	FFFF	FFFF	FFFF	FFFF	FFFF	FFFF	FFFF	FFFF	FFFF	FFFF	FFFF	FFFF	FFFF	FFFF	FFFF	FFFF
	Char.																
94D0	IBM	FFFF	FFFF	FFFF	FFFF	FFFF	FFFF	FFFF	FFFF	FFFF	FFFF	FFFF	FFFF	FFFF	FFFF	FFFF	FFFF
	Char.																
94E0	IBM	FFFF	FFFF	FFFF	FFFF	FFFF	FFFF	FFFF	FFFF	FFFF	FFFF	FFFF	FFFF	FFFF	FFFF	FFFF	FFFF
	Char.																
94F0	IBM	FFFF	FFFF	FFFF	FFFF	FFFF	FFFF	FFFF	FFFF	FFFF	FFFF	FFFF	FFFF	FFFF	FFFF	FFFF	
	Char.																
9540	IBM	FFFF	FFFF	FFFF	FFFF	FFFF	FFFF	FFFF	FFFF	FFFF	FFFF	FFFF	FFFF	FFFF	FFFF	FFFF	FFFF
	Char.																

Table B-4 Big5 à IBM Conversion Table (continued)

Big5		+ 0	+ 1	+ 2	+ 3	+ 4	+ 5	+ 6	+ 7	+ 8	+ 9	+ A	+ B	+ C	+ D	+ E	+ F
9550	IBM	FFFF	FFFF	FFFF	FFFF	FFFF	FFFF	FFFF	FFFF	FFFF	FFFF	FFFF	FFFF	FFFF	FFFF	FFFF	FFFF
	Char.																
9560	IBM	FFFF	FFFF	FFFF	FFFF	FFFF	FFFF	FFFF	FFFF	FFFF	FFFF	FFFF	FFFF	FFFF	FFFF	FFFF	FFFF
	Char.																
9570	IBM	FFFF	FFFF	FFFF	FFFF	FFFF	FFFF	FFFF	FFFF	FFFF	FFFF	FFFF	FFFF	FFFF	FFFF	FFFF	
	Char.																
95A0	IBM		FFFF	FFFF	FFFF	FFFF	FFFF	FFFF	FFFF	FFFF	FFFF	FFFF	FFFF	FFFF	FFFF	FFFF	FFFF
	Char.																
95B0	IBM	FFFF	FFFF	FFFF	FFFF	FFFF	FFFF	FFFF	FFFF	FFFF	FFFF	FFFF	FFFF	FFFF	FFFF	FFFF	FFFF
	Char.																
95C0	IBM	FFFF	FFFF	FFFF	FFFF	FFFF	FFFF	FFFF	FFFF	FFFF	FFFF	FFFF	FFFF	FFFF	FFFF	FFFF	FFFF
	Char.																
95D0	IBM	FFFF	FFFF	FFFF	FFFF	FFFF	FFFF	FFFF	FFFF	FFFF	FFFF	FFFF	FFFF	FFFF	FFFF	FFFF	FFFF
	Char.																
95E0	IBM	FFFF	FFFF	FFFF	FFFF	FFFF	FFFF	FFFF	FFFF	FFFF	FFFF	FFFF	FFFF	FFFF	FFFF	FFFF	FFFF
	Char.																
95F0	IBM	FFFF	FFFF	FFFF	FFFF	FFFF	FFFF	FFFF	FFFF	FFFF	FFFF	FFFF	FFFF	FFFF	FFFF	FFFF	
	Char.																
9640	IBM	FFFF	FFFF	FFFF	FFFF	FFFF	FFFF	FFFF	FFFF	FFFF	FFFF	FFFF	FFFF	FFFF	FFFF	FFFF	FFFF
	Char.																
9650	IBM	FFFF	FFFF	FFFF	FFFF	FFFF	FFFF	FFFF	FFFF	FFFF	FFFF	FFFF	FFFF	FFFF	FFFF	FFFF	FFFF
	Char.																
9660	IBM	FFFF	FFFF	FFFF	FFFF	FFFF	FFFF	FFFF	FFFF	FFFF	FFFF	FFFF	FFFF	FFFF	FFFF	FFFF	FFFF
	Char.																

Table B-4 Big5 à IBM Conversion Table (continued)

Big5		+ 0	+ 1	+ 2	+ 3	+ 4	+ 5	+ 6	+ 7	+ 8	+ 9	+ A	+ B	+ C	+ D	+ E	+ F
9670	IBM	FFFF	FFFF	FFFF	FFFF	FFFF	FFFF	FFFF	FFFF	FFFF	FFFF	FFFF	FFFF	FFFF	FFFF	FFFF	
	Char.																
96A0	IBM		FFFF	FFFF	FFFF	FFFF	FFFF	FFFF	FFFF	FFFF	FFFF	FFFF	FFFF	FFFF	FFFF	FFFF	FFFF
	Char.																
96B0	IBM	FFFF	FFFF	FFFF	FFFF	FFFF	FFFF	FFFF	FFFF	FFFF	FFFF	FFFF	FFFF	FFFF	FFFF	FFFF	FFFF
	Char.																
96C0	IBM	FFFF	FFFF	FFFF	FFFF	FFFF	FFFF	FFFF	FFFF	FFFF	FFFF	FFFF	FFFF	FFFF	FFFF	FFFF	FFFF
	Char.																
96D0	IBM	FFFF	FFFF	FFFF	FFFF	FFFF	FFFF	FFFF	FFFF	FFFF	FFFF	FFFF	FFFF	FFFF	FFFF	FFFF	FFFF
	Char.																
96E0	IBM	FFFF	FFFF	FFFF	FFFF	FFFF	FFFF	FFFF	FFFF	FFFF	FFFF	FFFF	FFFF	FFFF	FFFF	FFFF	FFFF
	Char.																
96F0	IBM	FFFF	FFFF	FFFF	FFFF	FFFF	FFFF	FFFF	FFFF	FFFF	FFFF	FFFF	FFFF	FFFF	FFFF	FFFF	
	Char.																
9740	IBM	FFFF	FFFF	FFFF	FFFF	FFFF	FFFF	FFFF	FFFF	FFFF	FFFF	FFFF	FFFF	FFFF	FFFF	FFFF	FFFF
	Char.																
9750	IBM	FFFF	FFFF	FFFF	FFFF	FFFF	FFFF	FFFF	FFFF	FFFF	FFFF	FFFF	FFFF	FFFF	FFFF	FFFF	FFFF
	Char.																
9760	IBM	FFFF	FFFF	FFFF	FFFF	FFFF	FFFF	FFFF	FFFF	FFFF	FFFF	FFFF	FFFF	FFFF	FFFF	FFFF	FFFF
	Char.																
9770	IBM	FFFF	FFFF	FFFF	FFFF	FFFF	FFFF	FFFF	FFFF	FFFF	FFFF	FFFF	FFFF	FFFF	FFFF	FFFF	
	Char.																

Table B-4 Big5 à IBM Conversion Table (continued)

Big5		+ 0	+ 1	+ 2	+ 3	+ 4	+ 5	+ 6	+ 7	+ 8	+ 9	+ A	+ B	+ C	+ D	+ E	+ F
97A0	IBM		FFFF	FFFF	FFFF	FFFF	FFFF	FFFF	FFFF	FFFF	FFFF	FFFF	FFFF	FFFF	FFFF	FFFF	FFFF
	Char.																
97B0	IBM	FFFF	FFFF	FFFF	FFFF	FFFF	FFFF	FFFF	FFFF	FFFF	FFFF	FFFF	FFFF	FFFF	FFFF	FFFF	FFFF
	Char.																
97C0	IBM	FFFF	FFFF	FFFF	FFFF	FFFF	FFFF	FFFF	FFFF	FFFF	FFFF	FFFF	FFFF	FFFF	FFFF	FFFF	FFFF
	Char.																
97D0	IBM	FFFF	FFFF	FFFF	FFFF	FFFF	FFFF	FFFF	FFFF	FFFF	FFFF	FFFF	FFFF	FFFF	FFFF	FFFF	FFFF
	Char.																
97E0	IBM	FFFF	FFFF	FFFF	FFFF	FFFF	FFFF	FFFF	FFFF	FFFF	FFFF	FFFF	FFFF	FFFF	FFFF	FFFF	FFFF
	Char.																
97F0	IBM	FFFF	FFFF	FFFF	FFFF	FFFF	FFFF	FFFF	FFFF	FFFF	FFFF	FFFF	FFFF	FFFF	FFFF	FFFF	FFFF
	Char.																
9840	IBM	FFFF	FFFF	FFFF	FFFF	FFFF	FFFF	FFFF	FFFF	FFFF	FFFF	FFFF	FFFF	FFFF	FFFF	FFFF	FFFF
	Char.																
9850	IBM	FFFF	FFFF	FFFF	FFFF	FFFF	FFFF	FFFF	FFFF	FFFF	FFFF	FFFF	FFFF	FFFF	FFFF	FFFF	FFFF
	Char.																
9860	IBM	FFFF	FFFF	FFFF	FFFF	FFFF	FFFF	FFFF	FFFF	FFFF	FFFF	FFFF	FFFF	FFFF	FFFF	FFFF	FFFF
	Char.																
9870	IBM	FFFF	FFFF	FFFF	FFFF	FFFF	FFFF	FFFF	FFFF	FFFF	FFFF	FFFF	FFFF	FFFF	FFFF	FFFF	FFFF
	Char.																
98A0	IBM		FFFF	FFFF	FFFF	FFFF	FFFF	FFFF	FFFF	FFFF	FFFF	FFFF	FFFF	FFFF	FFFF	FFFF	FFFF
	Char.																
98B0	IBM	FFFF	FFFF	FFFF	FFFF	FFFF	FFFF	FFFF	FFFF	FFFF	FFFF	FFFF	FFFF	FFFF	FFFF	FFFF	FFFF
	Char.																

Table B-4 Big5 à IBM Conversion Table (continued)

Big5		+ 0	+ 1	+ 2	+ 3	+ 4	+ 5	+ 6	+ 7	+ 8	+ 9	+ A	+ B	+ C	+ D	+ E	+ F
98C0	IBM	FFFF	FFFF	FFFF	FFFF	FFFF	FFFF	FFFF	FFFF	FFFF	FFFF	FFFF	FFFF	FFFF	FFFF	FFFF	FFFF
	Char.																
98D0	IBM	FFFF	FFFF	FFFF	FFFF	FFFF	FFFF	FFFF	FFFF	FFFF	FFFF	FFFF	FFFF	FFFF	FFFF	FFFF	FFFF
	Char.																
98E0	IBM	FFFF	FFFF	FFFF	FFFF	FFFF	FFFF	FFFF	FFFF	FFFF	FFFF	FFFF	FFFF	FFFF	FFFF	FFFF	FFFF
	Char.																
98F0	IBM	FFFF	FFFF	FFFF	FFFF	FFFF	FFFF	FFFF	FFFF	FFFF	FFFF	FFFF	FFFF	FFFF	FFFF	FFFF	FFFF
	Char.																
9940	IBM	FFFF	FFFF	FFFF	FFFF	FFFF	FFFF	FFFF	FFFF	FFFF	FFFF	FFFF	FFFF	FFFF	FFFF	FFFF	FFFF
	Char.																
9950	IBM	FFFF	FFFF	FFFF	FFFF	FFFF	FFFF	FFFF	FFFF	FFFF	FFFF	FFFF	FFFF	FFFF	FFFF	FFFF	FFFF
	Char.																
9960	IBM	FFFF	FFFF	FFFF	FFFF	FFFF	FFFF	FFFF	FFFF	FFFF	FFFF	FFFF	FFFF	FFFF	FFFF	FFFF	FFFF
	Char.																
9970	IBM	FFFF	FFFF	FFFF	FFFF	FFFF	FFFF	FFFF	FFFF	FFFF	FFFF	FFFF	FFFF	FFFF	FFFF	FFFF	FFFF
	Char.																
99A0	IBM		FFFF	FFFF	FFFF	FFFF	FFFF	FFFF	FFFF	FFFF	FFFF	FFFF	FFFF	FFFF	FFFF	FFFF	FFFF
	Char.																
99B0	IBM	FFFF	FFFF	FFFF	FFFF	FFFF	FFFF	FFFF	FFFF	FFFF	FFFF	FFFF	FFFF	FFFF	FFFF	FFFF	FFFF
	Char.																
99C0	IBM	FFFF	FFFF	FFFF	FFFF	FFFF	FFFF	FFFF	FFFF	FFFF	FFFF	FFFF	FFFF	FFFF	FFFF	FFFF	FFFF
	Char.																
99D0	IBM	FFFF	FFFF	FFFF	FFFF	FFFF	FFFF	FFFF	FFFF	FFFF	FFFF	FFFF	FFFF	FFFF	FFFF	FFFF	FFFF
	Char.																

Table B-4 Big5 à IBM Conversion Table (continued)

Big5		+ 0	+ 1	+ 2	+ 3	+ 4	+ 5	+ 6	+ 7	+ 8	+ 9	+ A	+ B	+ C	+ D	+ E	+ F
99E0	IBM	FFFF	FFFF	FFFF	FFFF	FFFF	FFFF	FFFF	FFFF	FFFF	FFFF	FFFF	FFFF	FFFF	FFFF	FFFF	FFFF
	Char.																
99F0	IBM	FFFF	FFFF	FFFF	FFFF	FFFF	FFFF	FFFF	FFFF	FFFF	FFFF	FFFF	FFFF	FFFF	FFFF	FFFF	FFFF
	Char.																
9A40	IBM	FFFF	FFFF	FFFF	FFFF	FFFF	FFFF	FFFF	FFFF	FFFF	FFFF	FFFF	FFFF	FFFF	FFFF	FFFF	FFFF
	Char.																
9A50	IBM	FFFF	FFFF	FFFF	FFFF	FFFF	FFFF	FFFF	FFFF	FFFF	FFFF	FFFF	FFFF	FFFF	FFFF	FFFF	FFFF
	Char.																
9A60	IBM	FFFF	FFFF	FFFF	FFFF	FFFF	FFFF	FFFF	FFFF	FFFF	FFFF	FFFF	FFFF	FFFF	FFFF	FFFF	FFFF
	Char.																
9A70	IBM	FFFF	FFFF	FFFF	FFFF	FFFF	FFFF	FFFF	FFFF	FFFF	FFFF	FFFF	FFFF	FFFF	FFFF	FFFF	FFFF
	Char.																
9AA0	IBM		FFFF	FFFF	FFFF	FFFF	FFFF	FFFF	FFFF	FFFF	FFFF	FFFF	FFFF	FFFF	FFFF	FFFF	FFFF
	Char.																
9AB0	IBM	FFFF	FFFF	FFFF	FFFF	FFFF	FFFF	FFFF	FFFF	FFFF	FFFF	FFFF	FFFF	FFFF	FFFF	FFFF	FFFF
	Char.																
9AC0	IBM	FFFF	FFFF	FFFF	FFFF	FFFF	FFFF	FFFF	FFFF	FFFF	FFFF	FFFF	FFFF	FFFF	FFFF	FFFF	FFFF
	Char.																
9AD0	IBM	FFFF	FFFF	FFFF	FFFF	FFFF	FFFF	FFFF	FFFF	FFFF	FFFF	FFFF	FFFF	FFFF	FFFF	FFFF	FFFF
	Char.																
9AE0	IBM	FFFF	FFFF	FFFF	FFFF	FFFF	FFFF	FFFF	FFFF	FFFF	FFFF	FFFF	FFFF	FFFF	FFFF	FFFF	FFFF
	Char.																
9AF0	IBM	FFFF	FFFF	FFFF	FFFF	FFFF	FFFF	FFFF	FFFF	FFFF	FFFF	FFFF	FFFF	FFFF	FFFF	FFFF	FFFF
	Char.																

Table B-4 Big5 à IBM Conversion Table (continued)

Big5		+ 0	+ 1	+ 2	+ 3	+ 4	+ 5	+ 6	+ 7	+ 8	+ 9	+ A	+ B	+ C	+ D	+ E	+ F
9B40	IBM	FFFF	FFFF	FFFF	FFFF	FFFF	FFFF	FFFF	FFFF	FFFF	FFFF	FFFF	FFFF	FFFF	FFFF	FFFF	FFFF
	Char.																
9B50	IBM	FFFF	FFFF	FFFF	FFFF	FFFF	FFFF	FFFF	FFFF	FFFF	FFFF	FFFF	FFFF	FFFF	FFFF	FFFF	FFFF
	Char.																
9B60	IBM	FFFF	FFFF	FFFF	FFFF	FFFF	FFFF	FFFF	FFFF	FFFF	FFFF	FFFF	FFFF	FFFF	FFFF	FFFF	FFFF
	Char.																
9B70	IBM	FFFF	FFFF	FFFF	FFFF	FFFF	FFFF	FFFF	FFFF	FFFF	FFFF	FFFF	FFFF	FFFF	FFFF	FFFF	FFFF
	Char.																
9BA0	IBM		FFFF	FFFF	FFFF	FFFF	FFFF	FFFF	FFFF	FFFF	FFFF	FFFF	FFFF	FFFF	FFFF	FFFF	FFFF
	Char.																
9BB0	IBM	FFFF	FFFF	FFFF	FFFF	FFFF	FFFF	FFFF	FFFF	FFFF	FFFF	FFFF	FFFF	FFFF	FFFF	FFFF	FFFF
	Char.																
9BC0	IBM	FFFF	FFFF	FFFF	FFFF	FFFF	FFFF	FFFF	FFFF	FFFF	FFFF	FFFF	FFFF	FFFF	FFFF	FFFF	FFFF
	Char.																
9BD0	IBM	FFFF	FFFF	FFFF	FFFF	FFFF	FFFF	FFFF	FFFF	FFFF	FFFF	FFFF	FFFF	FFFF	FFFF	FFFF	FFFF
	Char.																
9BE0	IBM	FFFF	FFFF	FFFF	FFFF	FFFF	FFFF	FFFF	FFFF	FFFF	FFFF	FFFF	FFFF	FFFF	FFFF	FFFF	FFFF
	Char.																
9BF0	IBM	FFFF	FFFF	FFFF	FFFF	FFFF	FFFF	FFFF	FFFF	FFFF	FFFF	FFFF	FFFF	FFFF	FFFF	FFFF	FFFF
	Char.																
9C40	IBM	FFFF	FFFF	FFFF	FFFF	FFFF	FFFF	FFFF	FFFF	FFFF	FFFF	FFFF	FFFF	FFFF	FFFF	FFFF	FFFF
	Char.																
9C50	IBM	FFFF	FFFF	FFFF	FFFF	FFFF	FFFF	FFFF	FFFF	FFFF	FFFF	FFFF	FFFF	FFFF	FFFF	FFFF	FFFF
	Char.																

Table B-4 Big5 à IBM Conversion Table (continued)

Big5		+ 0	+ 1	+ 2	+ 3	+ 4	+ 5	+ 6	+ 7	+ 8	+ 9	+ A	+ B	+ C	+ D	+ E	+ F
9C60	IBM	FFFF	FFFF	FFFF	FFFF	FFFF	FFFF	FFFF	FFFF	FFFF	FFFF	FFFF	FFFF	FFFF	FFFF	FFFF	FFFF
	Char.																
9C70	IBM	FFFF	FFFF	FFFF	FFFF	FFFF	FFFF	FFFF	FFFF	FFFF	FFFF	FFFF	FFFF	FFFF	FFFF	FFFF	FFFF
	Char.																
9CA0	IBM		FFFF	FFFF	FFFF	FFFF	FFFF	FFFF	FFFF	FFFF	FFFF	FFFF	FFFF	FFFF	FFFF	FFFF	FFFF
	Char.																
9CB0	IBM	FFFF	FFFF	FFFF	FFFF	FFFF	FFFF	FFFF	FFFF	FFFF	FFFF	FFFF	FFFF	FFFF	FFFF	FFFF	FFFF
	Char.																
9CC0	IBM	FFFF	FFFF	FFFF	FFFF	FFFF	FFFF	FFFF	FFFF	FFFF	FFFF	FFFF	FFFF	FFFF	FFFF	FFFF	FFFF
	Char.																
9CD0	IBM	FFFF	FFFF	FFFF	FFFF	FFFF	FFFF	FFFF	FFFF	FFFF	FFFF	FFFF	FFFF	FFFF	FFFF	FFFF	FFFF
	Char.																
9CE0	IBM	FFFF	FFFF	FFFF	FFFF	FFFF	FFFF	FFFF	FFFF	FFFF	FFFF	FFFF	FFFF	FFFF	FFFF	FFFF	FFFF
	Char.																
9CF0	IBM	FFFF	FFFF	FFFF	FFFF	FFFF	FFFF	FFFF	FFFF	FFFF	FFFF	FFFF	FFFF	FFFF	FFFF	FFFF	FFFF
	Char.																
9D40	IBM	FFFF	FFFF	FFFF	FFFF	FFFF	FFFF	FFFF	FFFF	FFFF	FFFF	FFFF	FFFF	FFFF	FFFF	FFFF	FFFF
	Char.																
9D50	IBM	FFFF	FFFF	FFFF	FFFF	FFFF	FFFF	FFFF	FFFF	FFFF	FFFF	FFFF	FFFF	FFFF	FFFF	FFFF	FFFF
	Char.																
9D60	IBM	FFFF	FFFF	FFFF	FFFF	FFFF	FFFF	FFFF	FFFF	FFFF	FFFF	FFFF	FFFF	FFFF	FFFF	FFFF	FFFF
	Char.																
9D70	IBM	FFFF	FFFF	FFFF	FFFF	FFFF	FFFF	FFFF	FFFF	FFFF	FFFF	FFFF	FFFF	FFFF	FFFF	FFFF	FFFF
	Char.																

Table B-4 Big5 à IBM Conversion Table (continued)

Big5		+ 0	+ 1	+ 2	+ 3	+ 4	+ 5	+ 6	+ 7	+ 8	+ 9	+ A	+ B	+ C	+ D	+ E	+ F
9DA0	IBM		FFFF	FFFF	FFFF	FFFF	FFFF	FFFF	FFFF	FFFF	FFFF	FFFF	FFFF	FFFF	FFFF	FFFF	FFFF
	Char.																
9DB0	IBM	FFFF	FFFF	FFFF	FFFF	FFFF	FFFF	FFFF	FFFF	FFFF	FFFF	FFFF	FFFF	FFFF	FFFF	FFFF	FFFF
	Char.																
9DC0	IBM	FFFF	FFFF	FFFF	FFFF	FFFF	FFFF	FFFF	FFFF	FFFF	FFFF	FFFF	FFFF	FFFF	FFFF	FFFF	FFFF
	Char.																
9DD0	IBM	FFFF	FFFF	FFFF	FFFF	FFFF	FFFF	FFFF	FFFF	FFFF	FFFF	FFFF	FFFF	FFFF	FFFF	FFFF	FFFF
	Char.																
9DE0	IBM	FFFF	FFFF	FFFF	FFFF	FFFF	FFFF	FFFF	FFFF	FFFF	FFFF	FFFF	FFFF	FFFF	FFFF	FFFF	FFFF
	Char.																
9DF0	IBM	FFFF	FFFF	FFFF	FFFF	FFFF	FFFF	FFFF	FFFF	FFFF	FFFF	FFFF	FFFF	FFFF	FFFF	FFFF	FFFF
	Char.																
9E40	IBM	FFFF	FFFF	FFFF	FFFF	FFFF	FFFF	FFFF	FFFF	FFFF	FFFF	FFFF	FFFF	FFFF	FFFF	FFFF	FFFF
	Char.																
9E50	IBM	FFFF	FFFF	FFFF	FFFF	FFFF	FFFF	FFFF	FFFF	FFFF	FFFF	FFFF	FFFF	FFFF	FFFF	FFFF	FFFF
	Char.																
9E60	IBM	FFFF	FFFF	FFFF	FFFF	FFFF	FFFF	FFFF	FFFF	FFFF	FFFF	FFFF	FFFF	FFFF	FFFF	FFFF	FFFF
	Char.																
9E70	IBM	FFFF	FFFF	FFFF	FFFF	FFFF	FFFF	FFFF	FFFF	FFFF	FFFF	FFFF	FFFF	FFFF	FFFF	FFFF	FFFF
	Char.																
9EA0	IBM		FFFF	FFFF	FFFF	FFFF	FFFF	FFFF	FFFF	FFFF	FFFF	FFFF	FFFF	FFFF	FFFF	FFFF	FFFF
	Char.																
9EB0	IBM	FFFF	FFFF	FFFF	FFFF	FFFF	FFFF	FFFF	FFFF	FFFF	FFFF	FFFF	FFFF	FFFF	FFFF	FFFF	FFFF
	Char.																

Table B-4 Big5 à IBM Conversion Table (continued)

Big5		+ 0	+ 1	+ 2	+ 3	+ 4	+ 5	+ 6	+ 7	+ 8	+ 9	+ A	+ B	+ C	+ D	+ E	+ F
9ECO	IBM	FFFF	FFFF	FFFF	FFFF	FFFF	FFFF	FFFF	FFFF	FFFF	FFFF	FFFF	FFFF	FFFF	FFFF	FFFF	FFFF
	Char.																
9EDO	IBM	FFFF	FFFF	FFFF	FFFF	FFFF	FFFF	FFFF	FFFF	FFFF	FFFF	FFFF	FFFF	FFFF	FFFF	FFFF	FFFF
	Char.																
9EEO	IBM	FFFF	FFFF	FFFF	FFFF	FFFF	FFFF	FFFF	FFFF	FFFF	FFFF	FFFF	FFFF	FFFF	FFFF	FFFF	FFFF
	Char.																
9EFO	IBM	FFFF	FFFF	FFFF	FFFF	FFFF	FFFF	FFFF	FFFF	FFFF	FFFF	FFFF	FFFF	FFFF	FFFF	FFFF	FFFF
	Char.																
9F40	IBM	FFFF	FFFF	FFFF	FFFF	FFFF	FFFF	FFFF	FFFF	FFFF	FFFF	FFFF	FFFF	FFFF	FFFF	FFFF	FFFF
	Char.																
9F50	IBM	FFFF	FFFF	FFFF	FFFF	FFFF	FFFF	FFFF	FFFF	FFFF	FFFF	FFFF	FFFF	FFFF	FFFF	FFFF	FFFF
	Char.																
9F60	IBM	FFFF	FFFF	FFFF	FFFF	FFFF	FFFF	FFFF	FFFF	FFFF	FFFF	FFFF	FFFF	FFFF	FFFF	FFFF	FFFF
	Char.																
9F70	IBM	FFFF	FFFF	FFFF	FFFF	FFFF	FFFF	FFFF	FFFF	FFFF	FFFF	FFFF	FFFF	FFFF	FFFF	FFFF	FFFF
	Char.																
9FA0	IBM		FFFF	FFFF	FFFF	FFFF	FFFF	FFFF	FFFF	FFFF	FFFF	FFFF	FFFF	FFFF	FFFF	FFFF	FFFF
	Char.																
9FB0	IBM	FFFF	FFFF	FFFF	FFFF	FFFF	FFFF	FFFF	FFFF	FFFF	FFFF	FFFF	FFFF	FFFF	FFFF	FFFF	FFFF
	Char.																
9FC0	IBM	FFFF	FFFF	FFFF	FFFF	FFFF	FFFF	FFFF	FFFF	FFFF	FFFF	FFFF	FFFF	FFFF	FFFF	FFFF	FFFF
	Char.																
9FDO	IBM	FFFF	FFFF	FFFF	FFFF	FFFF	FFFF	FFFF	FFFF	FFFF	FFFF	FFFF	FFFF	FFFF	FFFF	FFFF	FFFF
	Char.																

Table B-4 Big5 à IBM Conversion Table (continued)

Big5		+ 0	+ 1	+ 2	+ 3	+ 4	+ 5	+ 6	+ 7	+ 8	+ 9	+ A	+ B	+ C	+ D	+ E	+ F
9FE0	IBM	FFFF	FFFF	FFFF	FFFF	FFFF	FFFF	FFFF	FFFF	FFFF	FFFF	FFFF	FFFF	FFFF	FFFF	FFFF	FFFF
	Char.																
9FF0	IBM	FFFF	FFFF	FFFF	FFFF	FFFF	FFFF	FFFF	FFFF	FFFF	FFFF	FFFF	FFFF	FFFF	FFFF	FFFF	
	Char.																
A040	IBM	FFFF	FFFF	FFFF	FFFF	FFFF	FFFF	FFFF	FFFF	FFFF	FFFF	FFFF	FFFF	FFFF	FFFF	FFFF	FFFF
	Char.																
A050	IBM	FFFF	FFFF	FFFF	FFFF	FFFF	FFFF	FFFF	FFFF	FFFF	FFFF	FFFF	FFFF	FFFF	FFFF	FFFF	FFFF
	Char.																
A060	IBM	FFFF	FFFF	FFFF	FFFF	FFFF	FFFF	FFFF	FFFF	FFFF	FFFF	FFFF	FFFF	FFFF	FFFF	FFFF	FFFF
	Char.																
A070	IBM	FFFF	FFFF	FFFF	FFFF	FFFF	FFFF	FFFF	FFFF	FFFF	FFFF	FFFF	FFFF	FFFF	FFFF	FFFF	
	Char.																
A0A0	IBM		FFFF	FFFF	FFFF	FFFF	FFFF	FFFF	FFFF	FFFF	FFFF	FFFF	FFFF	FFFF	FFFF	FFFF	FFFF
	Char.																
A0B0	IBM	FFFF	FFFF	FFFF	FFFF	FFFF	FFFF	FFFF	FFFF	FFFF	FFFF	FFFF	FFFF	FFFF	FFFF	FFFF	FFFF
	Char.																
A0C0	IBM	FFFF	FFFF	FFFF	FFFF	FFFF	FFFF	FFFF	FFFF	FFFF	FFFF	FFFF	FFFF	FFFF	FFFF	FFFF	FFFF
	Char.																
A0D0	IBM	FFFF	FFFF	FFFF	FFFF	FFFF	FFFF	FFFF	FFFF	FFFF	FFFF	FFFF	FFFF	FFFF	FFFF	FFFF	FFFF
	Char.																
A0E0	IBM	FFFF	FFFF	FFFF	FFFF	FFFF	FFFF	FFFF	FFFF	FFFF	FFFF	FFFF	FFFF	FFFF	FFFF	FFFF	FFFF
	Char.																
A0F0	IBM	FFFF	FFFF	FFFF	FFFF	FFFF	FFFF	FFFF	FFFF	FFFF	FFFF	FFFF	FFFF	FFFF	FFFF	FFFF	
	Char.																

Table B-4 Big5 à IBM Conversion Table (continued)

Big5		+ 0	+ 1	+ 2	+ 3	+ 4	+ 5	+ 6	+ 7	+ 8	+ 9	+ A	+ B	+ C	+ D	+ E	+ F
A140	IBM	4040	426B	4344	4341	424B	4345	425E	427A	426F	425A	4741	447F	447E	4742	4743	4744
	Char.		,	,	。	。	。	；	：	？	！	：	，	、	。
A150	IBM	46E5	4745	4746	4747	4748	46A7	444A	4749	474A	46A8	46A9	46AA	46AB	424D	425D	46AC
	Char.	。	；	：	？	！		-		-		-	{	~	()	^
A160	IBM	46AD	42C0	42D0	46AE	46AF	4463	4473	46B0	46B1	4466	4476	46A4	46A5	4465	4475	46B2
	Char.	˘	{	}	˘	˘	[]	˘	˘	[]	˘	˘	《	》	˘
A170	IBM	46B3	4464	4474	46B4	46B5	4342	4343	46A0	46A1	4442	4443	46A2	46A3	474B	474C	
	Char.	˘	<	>	˘	˘	「	」	˘	˘	『	』	˘	˘	()	
A1A0	IBM		474D	474E	474F	4750	4461	4471	4462	4472	46E9	46EA	4279	4450	427B	4250	46B8
	Char.		{	}	{	}	'	'	"	"	"	"	'	'	#	&	*
A1B0	IBM	446B	446A	46B9	44E0	44E1	44E2	44E3	44E4	44E5	44E6	44E7	44E8	44E9	44EA	44EB	44EC
	Char.	※	\$	"	。	•	△	▲	◎	☆	★	◇	◆	□	■	▽	▼
A1C0	IBM	46BA	46BB	42A1	4751	426D	4752	46BE	46BF	46C0	46C1	46C2	46C3	4753	4754	46C4	424E
	Char.	Ⓔ	%	-	—	—	—	˘	˘	#	&	*	+
A1D0	IBM	4260	447A	447B	444B	46C5	424C	426E	427E	4467	4477	444C	444D	46C6	46C7	4755	4756
	Char.	-	x	÷	±	√	<	>	=	≤	≥	≠	∞	≡	≡	+	-
A1E0	IBM	4757	4758	4759	43A1	46C8	46C9	46C A	46C B	46C C	46C D	46CE	46CF	46D 0	46D1	4478	4468
	Char.	<	>	=	~	∩	∪	⊥	∠	∠	∠	log	ln	∫	∫	∴	∴
A1F0	IBM	4479	4469	46D2	46D 3	44F2	44F3	44F1	44F0	46D 4	46D 5	46D 6	46D7	447C	424F	4261	
	Char.	♀	♂	⊕	⊙	↑	↓	←	→	↖	↗	✓	↘	∥		/	
A240	IBM	43E0	46D A	475A	42E0	425B	446C	434A	424A	426C	427C	444E	46D B	475B	475C	475D	46D C
	Char.	\	/	\	\$	¥	₹	¢	£	%	@	°C	°F	\$	%	@	mil

Table B-4 Big5 à IBM Conversion Table (continued)

Big5		+ 0	+ 1	+ 2	+ 3	+ 4	+ 5	+ 6	+ 7	+ 8	+ 9	+ A	+ B	+ C	+ D	+ E	+ F
A250	IBM	46DD	46DE	46DF	46E0	46E1	46E2	46E3	46E4	44ED	46F1	46F2	46F3	46F4	46F5	46F6	46F7
	Char.	mm	cm	km	KM	m ²	mg	kg	cc	°	尪	尫	尬	尭	尮	尯	尰
A260	IBM	46F8	46F9	4660	4661	4662	4663	4664	4665	4666	4667	4668	4669	466A	466B	466C	466D
	Char.	𠄎	𠄏	—	—	■	■	■	■	■	■				■	■	■
A270	IBM	466E	466F	4670	4671	4672	4673	4674	4675	4676	4677	4678	4679	467A	467B	467C	
	Char.	■	+	+	+	+	+	+	+	+	+	+	+	+	+	+	
A2A0	IBM		467D	467E	467F	4681	4682	4683	4684	4685	4686	4687	4688	4689	468A	468B	42F0
	Char.		𠄒	𠄓	𠄔	—	+	+	+	+	+	+	+	+	+	+	o
A2B0	IBM	42F1	42F2	42F3	42F4	42F5	42F6	42F7	42F8	42F9	41F1	41F2	41F3	41F4	41F5	41F6	41F7
	Char.	1	2	3	4	5	6	7	8	9	I	II	III	IV	V	VI	VII
A2C0	IBM	41F8	41F9	41FA	4541	4542	4543	4544	4545	4546	4547	4548	4549	454A	454B	454C	42C1
	Char.	VIII	IX	X				又	𠄑	+	+	三	文	+	卅	卅	A
A2D0	IBM	42C2	42C3	42C4	42C5	42C6	42C7	42C8	42C9	42D1	42D2	42D3	42D4	42D5	42D6	42D7	42D8
	Char.	B	C	D	E	F	G	H	I	J	K	L	M	N	O	P	Q
A2E0	IBM	42D9	42E2	42E3	42E4	42E5	42E6	42E7	42E8	42E9	4281	4282	4283	4284	4285	4286	4287
	Char.	R	S	T	U	V	W	X	Y	Z	a	b	c	d	e	f	g
A2F0	IBM	4288	4289	4291	4292	4293	4294	4295	4296	4297	4298	4299	42A2	42A3	42A4	42A5	
	Char.	h	i	j	k	l	m	n	o	p	q	r	s	t	u	v	
A340	IBM	42A6	42A7	42A8	42A9	4161	4162	4163	4164	4165	4166	4167	4168	4169	416A	416B	416C
	Char.	w	x	y	z	A	B	Г	Δ	E	Z	H	Θ	I	K	Λ	M
A350	IBM	416D	416E	416F	4170	4171	4172	4173	4174	4175	4176	4177	4178	4141	4142	4143	4144
	Char.	N	Ξ	O	Π	P	Σ	T	Υ	Φ	X	Ψ	Ω	α	β	γ	δ

Table B-4 Big5 à IBM Conversion Table (continued)

Big5		+ 0	+ 1	+ 2	+ 3	+ 4	+ 5	+ 6	+ 7	+ 8	+ 9	+ A	+ B	+ C	+ D	+ E	+ F
A360	IBM	4145	4146	4147	4148	4149	414A	414B	414C	414D	414E	414F	4150	4151	4152	4153	4154
	Char.	ε	ζ	η	θ	ι	κ	λ	μ	ν	ξ	ο	π	ρ	σ	τ	υ
A370	IBM	4155	4156	4157	4158	4556	4557	4558	4559	455A	455B	455C	455D	455E	455F	4560	
	Char.	φ	χ	ψ	ω	ς	ξ	π	ι	ς	ς	ς	ς	ς	ς	ς	
A3A0	IBM		4561	4562	4563	4564	4565	4566	4567	4568	4569	456A	456B	456C	456D	456E	456F
	Char.		υ	κ	τ	ϣ	ι	ρ	σ	ρ	ς	μ	γ	ς	ς	ς	ϣ
A3B0	IBM	4570	4571	4572	4573	4574	4575	4576	4577	4578	4579	457A	4555	4551	4552	4553	4554
	Char.	˘	˘	˘	˘	˘	˘	˘	˘	˘	˘	˘	˘	˘	˘	˘	˘
A3C0	IBM	FFFF	FFFF	FFFF	FFFF	FFFF	FFFF	FFFF	FFFF	FFFF	FFFF	FFFF	FFFF	FFFF	FFFF	FFFF	FFFF
	Char.																
A3D0	IBM	FFFF	FFFF	FFFF	FFFF	FFFF	FFFF	FFFF	FFFF	FFFF	FFFF	FFFF	FFFF	FFFF	FFFF	FFFF	FFFF
	Char.																
A3E0	IBM	FFFF	FFFF	FFFF	FFFF	FFFF	FFFF	FFFF	FFFF	FFFF	FFFF	FFFF	FFFF	FFFF	FFFF	FFFF	FFFF
	Char.																
A3F0	IBM	FFFF	FFFF	FFFF	FFFF	FFFF	FFFF	FFFF	FFFF	FFFF	FFFF	FFFF	FFFF	FFFF	FFFF	FFFF	FFFF
	Char.																
A440	IBM	4C41	4C42	4C43	4C44	4C45	4C46	4C47	4C48	4C49	4C4A	4C4B	4C4C	4C4D	4C4E	4C4F	4C50
	Char.	一	乙	丁	七	乃	九	了	二	人	儿	入	八	几	刀	刁	力
A450	IBM	4C51	4C52	4C53	4C54	4C55	4C56	4C57	4C58	4C59	4C5A	4C5B	4C5C	4C5D	4C5E	4C5F	4C60
	Char.	匕	十	卜	又	三	下	丈	上	丫	丸	凡	久	么	也	乞	于
A460	IBM	4C61	4C62	4C63	4C64	4C65	4C66	4C67	4C68	4C69	4C6A	4C6B	4C6C	4C6D	4C6E	4C6F	4C70
	Char.	亡	兀	刃	勺	千	叉	口	土	士	夕	大	女	子	子	子	寸
A470	IBM	4C71	4C72	4C73	4C74	4C75	4C76	4C77	4C78	4C79	4C7A	4C7B	4C7C	4C7D	4C7E	4C7F	
	Char.	小	尢	尸	山	川	工	己	巳	巳	巾	干	井	弋	弓	才	

Table B-4 Big5 à IBM Conversion Table (continued)

Big5		+ 0	+ 1	+ 2	+ 3	+ 4	+ 5	+ 6	+ 7	+ 8	+ 9	+ A	+ B	+ C	+ D	+ E	+ F
A4A0	IBM		4C81	4C82	4C83	4C84	4C85	4C86	4C87	4C88	4C89	4C8A	4C8B	4C8C	4C8D	4C8E	4C8F
	Char.		丑	丐	不	中	丰	丹	之	尹	予	云	井	互	五	亢	仁
A4B0	IBM	4C90	4C91	4C92	4C93	4C94	4C95	4C96	4C97	4C98	4C99	4C9A	4C9B	4C9C	4C9D	4C9E	4C9F
	Char.	什	汀	仆	仇	仍	今	介	仄	元	允	内	六	兮	公	冗	凶
A4C0	IBM	4CA0	4CA1	4CA2	4CA3	4CA4	4CA5	4CA6	4CA7	4CA8	4CA9	4CAA	4CAB	4CAC	4CAD	4CAE	4CAF
	Char.	分	切	刈	勻	勾	勿	化	匹	午	升	卅	卞	厄	友	及	反
A4D0	IBM	4CB0	4CB1	4CB2	4CB3	4CB4	4CB5	4CB6	4CB7	4CB8	4CB9	4CBA	4CBB	4CBC	4CBD	4CBE	4CBF
	Char.	壬	天	夫	太	夭	孔	少	尤	尺	屯	巴	幻	廿	弔	引	心
A4E0	IBM	4CC0	4CC1	4CC2	4CC3	4CC4	4CC5	4CC6	4CC7	4CC8	4CC9	4CCA	4CCB	4CCC	4CCD	4CCE	4CCF
	Char.	戈	戶	手	扎	支	文	斗	斤	方	日	日	月	木	欠	止	歹
A4F0	IBM	4CD0	4CD1	4CD2	4CD3	4CD4	4CD5	4CD6	4CD7	4CD8	4CD9	4CDA	4CDB	4CDC	4CDD	4CDE	
	Char.	毋	比	毛	氏	水	火	爪	父	爻	片	牙	牛	犬	王	丙	
A540	IBM	4CDF	4CE0	4CE1	4CE2	4CE3	4CE4	4CE5	4CE6	4CE7	4CE8	4CE9	4CEA	4CEB	4CEC	4CED	4CEE
	Char.	世	丕	且	丘	主	乍	乏	乎	以	付	仔	仕	他	仗	代	令
A550	IBM	4CEF	4CF0	4CF1	4CF2	4CF3	4CF4	4CF5	4CF6	4CF7	4CF8	4CF9	4CFA	4CFB	4CFC	4CFD	4D41
	Char.	仙	仞	充	兄	冉	冊	冬	凹	出	凸	刊	加	功	包	匆	北
A560	IBM	4D42	4D43	4D44	4D45	4D46	4D47	4D48	4D49	4D4A	4D4B	4D4C	4D4D	4D4E	4D4F	4D50	4D51
	Char.	匣	仟	半	卉	卡	占	卯	卮	去	可	古	右	召	叮	叩	叨
A570	IBM	4D52	4D53	4D54	4D55	4D56	4D57	4D58	4D59	4D5A	4D5B	4D5C	4D5D	4D5E	4D5F	4D60	
	Char.	叨	司	叵	叫	另	只	史	叱	台	句	叭	叻	四	囚	外	
A5A0	IBM		4D61	4D62	4D63	4D64	4D65	4D66	4D67	4D68	4D69	4D6A	4D6B	4D6C	4D6D	4D6E	4D6F
	Char.		央	失	奴	奶	孕	它	尼	巨	巧	左	市	布	平	幼	弁
A5B0	IBM	4D70	4D71	4D72	4D73	4D74	4D75	4D76	4D77	4D78	4D79	4D7A	4D7B	4D7C	4D7D	4D7E	4D7F
	Char.	弘	弗	必	戊	打	扔	扒	扑	斥	旦	朮	本	未	末	札	正

Table B-4 Big5 à IBM Conversion Table (continued)

Big5		+ 0	+ 1	+ 2	+ 3	+ 4	+ 5	+ 6	+ 7	+ 8	+ 9	+ A	+ B	+ C	+ D	+ E	+ F
A5C0	IBM	4D81	4D82	4D83	4D84	4D85	4D86	4D87	4D88	4D89	4D8A	4D8B	4D8C	4D8D	4D8E	4D8F	4D90
	Char.	母	民	氏	永	汁	汀	汜	犯	玄	玉	瓜	瓦	甘	生	用	甩
A5D0	IBM	4D91	4D92	4D93	4D94	4D95	4D96	4D97	4D98	4D99	4D9A	4D9B	4D9C	4D9D	4D9E	4D9F	4DA0
	Char.	田	由	甲	申	疋	白	皮	皿	目	矛	矢	石	示	禾	穴	立
A5E0	IBM	4DA1	4DA2	4DA3	4DA4	4DA5	4DA6	4DA7	4DA8	4DA9	4DAA	4DAB	4DAC	4DAD	4DAE	4DAF	4DB0
	Char.	丞	丟	兵	兵	乚	互	交	亦	亥	仿	伉	伙	伊	佚	伍	伐
A5F0	IBM	4DB1	4DB2	4DB3	4DB4	4DB5	4DB6	4DB7	4DB8	4DB9	4DBA	4DBB	4DBC	4DBD	4DBE	4DBF	
	Char.	休	伏	仲	件	任	仰	批	份	企	級	光	兕	兆	先	全	
A640	IBM	4DC0	4DC1	4DC2	4DC3	4DC4	4DC5	4DC6	4DC7	4DC8	4DC9	4DCA	4DCB	4DCC	4DCD	4DCE	4DCF
	Char.	共	再	冰	列	刑	划	刎	刎	劣	甸	匡	匠	印	危	吉	吏
A650	IBM	4DD0	4DD1	4DD2	4DD3	4DD4	4DD5	4DD6	4DD7	4DD8	4DD9	4DDA	4ddb	4DDC	4DDD	4DDE	4DDF
	Char.	同	吊	吐	吁	吋	各	向	名	合	吃	后	吆	吒	因	回	团
A660	IBM	4DE0	4DE1	4DE2	4DE3	4DE4	4DE5	4DE6	4DE7	4DE8	4DE9	4DEA	4DEB	4DEC	4DED	4DEE	4DEF
	Char.	圳	地	在	圭	圪	圪	圩	夙	多	夷	夸	妄	奸	妃	好	她
A670	IBM	4DF0	4DF1	4DF2	4DF3	4DF4	4DF5	4DF6	4DF7	4DF8	4DF9	4DFA	4DFB	4DFC	4DFD	4E41	
	Char.	如	灼	字	存	宇	守	宅	安	寺	尖	屹	州	帆	并	年	
A6A0	IBM		4E42	4E43	4E44	4E45	4E46	4E47	4E48	4E49	4E4A	4E4B	4E4C	4E4D	4E4E	4E4F	4E50
	Char.		式	弛	忙	忖	戎	戌	戌	成	扣	扛	托	收	早	旨	旬
A6B0	IBM	4E51	4E52	4E53	4E54	4E55	4E56	4E57	4E58	4E59	4E5A	4E5B	4E5C	4E5D	4E5E	4E5F	4E60
	Char.	旭	曲	曳	有	朽	朴	朱	朶	次	此	死	氛	汝	汗	汗	江
A6C0	IBM	4E61	4E62	4E63	4E64	4E65	4E66	4E67	4E68	4E69	4E6A	4E6B	4E6C	4E6D	4E6E	4E6F	4E70
	Char.	池	汐	汕	污	汛	洑	汛	灰	牟	牝	百	竹	米	糸	缶	羊
A6D0	IBM	4E71	4E72	4E73	4E74	4E75	4E76	4E77	4E78	4E79	4E7A	4E7B	4E7C	4E7D	4E7E	4E7F	4E81
	Char.	羽	老	考	而	耒	耳	聿	肉	肋	肌	臣	自	至	臼	舌	舛

Table B-4 Big5 à IBM Conversion Table (continued)

Big5		+ 0	+ 1	+ 2	+ 3	+ 4	+ 5	+ 6	+ 7	+ 8	+ 9	+ A	+ B	+ C	+ D	+ E	+ F
A6E0	IBM	4E82	4E83	4E84	4E85	4E86	4E87	4E88	4E89	4E8A	4E8B	4E8C	4E8D	4E8E	4E8F	4E90	4E91
	Char.	舟	艮	色	艾	虫	血	行	衣	西	阡	串	亨	位	住	佇	佗
A6F0	IBM	4E92	4E93	4E94	4E95	4E96	4E97	4E98	4E99	4E9A	4E9B	4E9C	4E9D	4E9E	4E9F	4EA0	
	Char.	倭	伴	佛	何	估	佐	佑	伽	伺	伸	佃	佔	似	但	佣	
A740	IBM	4EA1	4EA2	4EA3	4EA4	4EA5	4EA6	4EA7	4EA8	4EA9	4EAA	4EAB	4EAC	4EAD	4EAE	4EAF	4EBO
	Char.	作	你	伯	低	伶	余	佝	佈	佚	兌	克	免	兵	冶	冷	別
A750	IBM	4EB1	4EB2	4EB3	4EB4	4EB5	4EB6	4EB7	4EB8	4EB9	4EBA	4EBB	4EBC	4EBD	4EBE	4EBF	4ECO
	Char.	判	利	刪	劊	劫	助	努	劬	匣	即	卵	吝	吭	吞	吾	否
A760	IBM	4EC1	4EC2	4EC3	4EC4	4EC5	4EC6	4EC7	4EC8	4EC9	4ECA	4ECB	4ECC	4ECD	4ECE	4ECF	4EDO
	Char.	呎	吧	呆	呃	吳	呈	呂	君	吩	告	吹	吻	吸	吮	吵	啞
A770	IBM	4ED1	4ED2	4ED3	4ED4	4ED5	4ED6	4ED7	4ED8	4ED9	4EDA	4EDB	4EDC	4EDD	4EDE	4EDF	
	Char.	吠	吼	呀	吱	含	吟	听	囟	困	囿	囿	坊	坑	址	坍	
A7A0	IBM		4EE0	4EE1	4EE2	4EE3	4EE4	4EE5	4EE6	4EE7	4EE8	4EE9	4EEA	4EEB	4EEC	4EED	4EEE
	Char.		均	坎	圾	坐	坏	圻	壯	夾	妝	妒	妨	妞	妣	妙	妖
A7B0	IBM	4EEF	4EF0	4EF1	4EF2	4EF3	4EF4	4EF5	4EF6	4EF7	4EF8	4EF9	4EFA	4EFB	4EFC	4EFD	4F41
	Char.	妍	姪	妓	妊	妥	孝	孜	孚	幸	完	宋	宏	尪	局	屁	尿
A7C0	IBM	4F42	4F43	4F44	4F45	4F46	4F47	4F48	4F49	4F4A	4F4B	4F4C	4F4D	4F4E	4F4F	4F50	4F51
	Char.	尾	岐	岑	岔	岌	巫	希	序	庇	床	廷	弄	弟	彤	彤	彷彿
A7D0	IBM	4F52	4F53	4F54	4F55	4F56	4F57	4F58	4F59	4F5A	4F5B	4F5C	4F5D	4F5E	4F5F	4F60	4F61
	Char.	役	忘	忌	志	忍	忱	快	忸	忸	戒	我	抄	抗	抖	技	扶
A7E0	IBM	4F62	4F63	4F64	4F65	4F66	4F67	4F68	4F69	4F6A	4F6B	4F6C	4F6D	4F6E	4F6F	4F70	4F71
	Char.	抉	扭	把	扼	找	批	扳	杼	扯	折	扮	投	抓	抑	攪	改
A7F0	IBM	4F72	4F73	4F74	4F75	4F76	4F77	4F78	4F79	4F7A	4F7B	4F7C	4F7D	4F7E	4F7F	4F81	
	Char.	攻	攸	旱	更	束	李	杏	材	村	社	杖	杞	杉	杆	杠	

Table B-4 Big5 à IBM Conversion Table (continued)

Big5		+ 0	+ 1	+ 2	+ 3	+ 4	+ 5	+ 6	+ 7	+ 8	+ 9	+ A	+ B	+ C	+ D	+ E	+ F
A840	IBM	4F82	4F83	4F84	4F85	4F86	4F87	4F88	4F89	4F8A	4F8B	4F8C	4F8D	4F8E	4F8F	4F90	4F91
	Char.	杓	宗	步	每	求	禾	沙	沁	沈	沉	沅	沛	汪	決	沐	汰
A850	IBM	4F92	4F93	4F94	4F95	4F96	4F97	4F98	4F99	4F9A	4F9B	4F9C	4F9D	4F9E	4F9F	4FA0	4FA1
	Char.	沌	汨	沖	沒	汽	沃	汲	汾	汴	沆	汶	洹	沔	泚	沂	灶
A860	IBM	4FA2	4FA3	4FA4	4FA5	4FA6	4FA7	4FA8	4FA9	4FAA	4FAB	4FAC	4FAD	4FAE	4FAF	4FB0	4FB1
	Char.	灼	災	灸	牢	牡	牠	狄	狂	玖	甬	甫	男	甸	皂	盯	矣
A870	IBM	4FB2	4FB3	4FB4	4FB5	4FB6	4FB7	4FB8	4FB9	4FBA	4FBB	4FBC	4FBD	4FBE	4FBF	4FC0	
	Char.	私	秀	禿	究	系	罕	肖	育	肝	肘	肛	肚	育	良	芒	
A8A0	IBM		4FC1	4FC2	4FC3	4FC4	4FC5	4FC6	4FC7	4FC8	4FC9	4FCA	4FCB	4FCC	4FCD	4FCE	4FCF
	Char.		芋	芍	見	角	言	谷	豆	豕	貝	赤	走	足	身	車	辛
A8B0	IBM	4FD0	4FD1	4FD2	4FD3	4FD4	4FD5	4FD6	4FD7	4FD8	4FD9	4FDA	4FDB	4FDC	4FDD	4FDE	4FDF
	Char.	辰	迂	迪	迅	迄	巡	邑	邢	邪	邦	那	酉	采	里	防	阮
A8C0	IBM	4FE0	4FE1	4FE2	4FE3	4FE4	4FE5	4FE6	4FE7	4FE8	4FE9	4FEA	4FEB	4FEC	4FED	4FEE	4FEF
	Char.	阱	阪	阬	並	乖	乳	事	些	亞	享	京	伴	依	侍	佳	使
A8D0	IBM	4FF0	4FF1	4FF2	4FF3	4FF4	4FF5	4FF6	4FF7	4FF8	4FF9	4FFA	4FFB	4FFC	4FFD	5041	5042
	Char.	佬	供	例	來	侃	佰	併	侈	佩	佻	侖	侷	侏	侑	侗	兔
A8E0	IBM	5043	5044	5045	5046	5047	5048	5049	504A	504B	504C	504D	504E	504F	5050	5051	5052
	Char.	兒	兇	兩	具	其	典	冽	函	刻	券	刷	刺	到	刮	制	剝
A8F0	IBM	5053	5054	5055	5056	5057	5058	5059	505A	505B	505C	505D	505E	505F	5060	5061	
	Char.	劬	勳	卒	協	卓	卑	卦	卷	卸	卹	取	叔	受	味	呵	
A940	IBM	5062	5063	5064	5065	5066	5067	5068	5069	506A	506B	506C	506D	506E	506F	5070	5071
	Char.	咖	呖	咕	咀	呻	呷	咄	咒	咆	呼	咐	呱	呶	和	咚	呢

Table B-4 Big5 à IBM Conversion Table (continued)

Big5		+ 0	+ 1	+ 2	+ 3	+ 4	+ 5	+ 6	+ 7	+ 8	+ 9	+ A	+ B	+ C	+ D	+ E	+ F
A950	IBM	5072	5073	5074	5075	5076	5077	5078	5079	507A	507B	507C	507D	507E	507F	5081	5082
	Char.	周	昨	命	咎	固	垃	珂	坪	坩	坡	坦	坤	坼	夜	奉	奇
A960	IBM	5083	5084	5085	5086	5087	5088	5089	508A	508B	508C	508D	508E	508F	5090	5091	5092
	Char.	奈	奄	奔	妾	妻	委	妹	妮	姑	姆	姐	姍	始	姓	姊	妯
A970	IBM	5093	5094	5095	5096	5097	5098	5099	509A	509B	509C	509D	509E	509F	50A0	50A1	
	Char.	妳	姒	姘	孟	孤	季	宗	定	官	宜	宙	宛	尚	屈	居	
A9A0	IBM		50A2	50A3	50A4	50A5	50A6	50A7	50A8	50A9	50AA	50AB	50AC	50AD	50AE	50AF	50B0
	Char.		屆	岷	岡	岸	岩	岫	岱	岳	帘	帚	帖	帕	帛	帑	幸
A9B0	IBM	50B1	50B2	50B3	50B4	50B5	50B6	50B7	50B8	50B9	50BA	50BB	50BC	50BD	50BE	50BF	50C0
	Char.	庚	店	府	底	庖	延	弦	弧	弩	往	征	佛	彼	忝	忠	忽
A9C0	IBM	50C1	50C2	50C3	50C4	50C5	50C6	50C7	50C8	50C9	50CA	50CB	50CC	50CD	50CE	50CF	50D0
	Char.	念	忿	快	怔	怯	忧	怖	怪	怕	怡	性	惘	佛	怛	或	戕
A9D0	IBM	50D1	50D2	50D3	50D4	50D5	50D6	50D7	50D8	50D9	50DA	50DB	50DC	50DD	50DE	50DF	50E0
	Char.	房	戾	所	承	拉	拌	拄	抵	拂	抹	拒	招	披	拓	拔	拋
A9E0	IBM	50E1	50E2	50E3	50E4	50E5	50E6	50E7	50E8	50E9	50EA	50EB	50EC	50ED	50EE	50EF	50F0
	Char.	拈	捍	抽	押	拐	拙	拇	拍	抵	拚	抱	拘	拖	拗	拆	拾
A9F0	IBM	50F1	50F2	50F3	50F4	50F5	50F6	50F7	50F8	50F9	50FA	50FB	50FC	50FD	5141	5142	
	Char.	拎	放	斧	於	旺	昔	易	昌	昆	昂	明	昀	昏	昕	昊	
AA40	IBM	5143	5144	5145	5146	5147	5148	5149	514A	514B	514C	514D	514E	514F	5150	5151	5152
	Char.	昇	服	朋	杭	枋	枕	東	果	杳	杷	枇	枝	林	杯	杰	板
AA50	IBM	5153	5154	5155	5156	5157	5158	5159	515A	515B	515C	515D	515E	515F	5160	5161	5162
	Char.	枉	松	析	杵	枚	料	杼	杪	杲	欣	武	歧	歿	氓	氛	泣

Table B-4 Big5 à IBM Conversion Table (continued)

Big5		+ 0	+ 1	+ 2	+ 3	+ 4	+ 5	+ 6	+ 7	+ 8	+ 9	+ A	+ B	+ C	+ D	+ E	+ F
AA60	IBM	5163	5164	5165	5166	5167	5168	5169	516A	516B	516C	516D	516E	516F	5170	5171	5172
	Char.	注	泳	沱	泌	泥	河	沽	沾	沼	波	沫	法	泓	沸	泄	油
AA70	IBM	5173	5174	5175	5176	5177	5178	5179	517A	517B	517C	517D	517E	517F	5181	5182	
	Char.	況	沮	泗	泗	決	沿	治	泡	泛	泊	沫	混	泚	柳	冷	
AAA0	IBM		5183	5184	5185	5186	5187	5188	5189	518A	518B	518C	518D	518E	518F	5190	5191
	Char.		炕	炎	炒	炊	灸	爬	爭	爸	版	牧	物	狀	狎	狙	狗
AAB0	IBM	5192	5193	5194	5195	5196	5197	5198	5199	519A	519B	519C	519D	519E	519F	51A0	51A1
	Char.	狐	玩	玗	玫	玫	玥	剛	疝	疙	疚	的	孟	盲	直	知	砂
AAC0	IBM	51A2	51A3	51A4	51A5	51A6	51A7	51A8	51A9	51AA	51AB	51AC	51AD	51AE	51AF	51B0	51B1
	Char.	社	祀	祗	乘	秬	空	穹	竺	糾	罔	羌	牟	者	肺	肥	肢
AAD0	IBM	51B2	51B3	51B4	51B5	51B6	51B7	51B8	51B9	51BA	51BB	51BC	51BD	51BE	51BF	51C0	51C1
	Char.	肱	股	肫	肩	肴	肪	肯	臥	輿	舍	芳	芝	芙	芭	芽	菱
AAE0	IBM	51C2	51C3	51C4	51C5	51C6	51C7	51C8	51C9	51CA	51CB	51CC	51CD	51CE	51CF	51D0	51D1
	Char.	芹	花	芬	芥	芯	芸	茱	菱	蒂	芷	虎	虱	初	表	軋	迎
AAF0	IBM	51D2	51D3	51D4	51D5	51D6	51D7	51D8	51D9	51DA	51DB	51DC	51DD	51DE	51DF	51E0	
	Char.	返	近	邵	邸	邱	邨	采	金	長	門	阜	陀	阿	阻	附	
AB40	IBM	51E1	51E2	51E3	51E4	51E5	51E6	51E7	51E8	51E9	51EA	51EB	51EC	51ED	51EE	51EF	51F0
	Char.	陂	隹	雨	青	非	亟	亭	亮	信	侵	侯	便	俠	僮	僭	保
AB50	IBM	51F1	51F2	51F3	51F4	51F5	51F6	51F7	51F8	51F9	51FA	51FB	51FC	51FD	5241	5242	5243
	Char.	促	侶	俘	俟	俊	俗	侮	俐	俄	係	俚	俎	俞	僞	堯	冒
AB60	IBM	5244	5245	5246	5247	5248	5249	524A	524B	524C	524D	524E	524F	5250	5251	5252	5253
	Char.	胄	冠	剝	剝	削	前	刺	剋	則	勇	勉	勃	勁	匍	南	卻
AB70	IBM	5254	5255	5256	5257	5258	5259	525A	525B	525C	525D	525E	525F	5260	5261	5262	
	Char.	厚	叛	咬	哀	咨	哎	哉	咸	噴	咳	哇	晒	咽	咪	品	

Table B-4 Big5 à IBM Conversion Table (continued)

Big5		+ 0	+ 1	+ 2	+ 3	+ 4	+ 5	+ 6	+ 7	+ 8	+ 9	+ A	+ B	+ C	+ D	+ E	+ F
ABAO	IBM		5263	5264	5265	5266	5267	5268	5269	526A	526B	526C	526D	526E	526F	5270	5271
	Char.		哄	哈	咯	咫	咱	咻	咩	咧	啣	囿	垂	型	垠	垣	垢
ABBO	IBM	5272	5273	5274	5275	5276	5277	5278	5279	527A	527B	527C	527D	527E	527F	5281	5282
	Char.	城	垮	垓	奕	契	奏	奎	奂	姜	姘	姿	姣	姨	娃	姥	姪
ABCO	IBM	5283	5284	5285	5286	5287	5288	5289	528A	528B	528C	528D	528E	528F	5290	5291	5292
	Char.	姚	姦	威	姻	孩	宣	宦	室	客	宥	封	屎	屏	屍	屋	峙
ABDO	IBM	5293	5294	5295	5296	5297	5298	5299	529A	529B	529C	529D	529E	529F	52A0	52A1	52A2
	Char.	峒	巷	帝	帥	帟	幽	庠	度	建	弈	弭	彥	很	待	徊	律
ABEO	IBM	52A3	52A4	52A5	52A6	52A7	52A8	52A9	52AA	52AB	52AC	52AD	52AE	52AF	52B0	52B1	52B2
	Char.	徇	後	徻	怒	思	怠	急	怎	怨	恍	恰	恨	恢	恆	恃	恬
ABFO	IBM	52B3	52B4	52B5	52B6	52B7	52B8	52B9	52BA	52BB	52BC	52BD	52BE	52BF	52C0	52C1	
	Char.	恫	恪	恤	扁	拜	挖	按	拼	拭	持	拮	拽	指	拱	拷	
AC40	IBM	52C2	52C3	52C4	52C5	52C6	52C7	52C8	52C9	52CA	52CB	52CC	52CD	52CE	52CF	52D0	52D1
	Char.	拯	括	拾	揜	挑	挂	政	故	斫	施	既	春	昭	映	味	是
AC50	IBM	52D2	52D3	52D4	52D5	52D6	52D7	52D8	52D9	52DA	52DB	52DC	52DD	52DE	52DF	52E0	52E1
	Char.	星	昨	昱	吟	曷	柿	染	柱	柔	某	柬	架	枯	柵	柩	柯
AC60	IBM	52E2	52E3	52E4	52E5	52E6	52E7	52E8	52E9	52EA	52EB	52EC	52ED	52EE	52EF	52F0	52F1
	Char.	柄	柑	枊	柚	查	枸	柏	柞	柳	柁	桤	柢	柝	柒	歪	殃
AC70	IBM	52F2	52F3	52F4	52F5	52F6	52F7	52F8	52F9	52FA	52FB	52FC	52FD	5341	5342	5343	
	Char.	殆	段	毒	毗	氟	泉	洋	洲	洪	流	津	洌	洱	洞	洗	
ACAO	IBM		5344	5345	5346	5347	5348	5349	534A	534B	534C	534D	534E	534F	5350	5351	5352
	Char.		活	洽	派	洵	洛	泵	涸	洧	洸	洩	洮	洵	洎	洫	炫
ACB0	IBM	5353	5354	5355	5356	5357	5358	5359	535A	535B	535C	535D	535E	535F	5360	5361	5362
	Char.	為	炳	炬	炯	炭	炸	炮	炤	爰	牲	牯	牴	犴	狠	狡	玷

Table B-4 Big5 à IBM Conversion Table (continued)

Big5		+ 0	+ 1	+ 2	+ 3	+ 4	+ 5	+ 6	+ 7	+ 8	+ 9	+ A	+ B	+ C	+ D	+ E	+ F
ACCO	IBM	5363	5364	5365	5366	5367	5368	5369	536A	536B	536C	536D	536E	536F	5370	5371	5372
	Char.	珊	玻	玲	珍	珀	玳	碁	甬	畏	界	猷	畷	疫	疤	疥	痰
ACD0	IBM	5373	5374	5375	5376	5377	5378	5379	537A	537B	537C	537D	537E	537F	5381	5382	5383
	Char.	疣	癸	皆	皇	販	盈	盆	盃	盅	省	吨	相	眉	看	盾	盼
ACE0	IBM	5384	5385	5386	5387	5388	5389	538A	538B	538C	538D	538E	538F	5390	5391	5392	5393
	Char.	眇	矜	砂	研	砌	砍	祆	祉	折	祇	禹	禺	科	秒	秋	穿
ACF0	IBM	5394	5395	5396	5397	5398	5399	539A	539B	539C	539D	539E	539F	53A0	53A1	53A2	
	Char.	突	竿	竿	籽	紂	紅	紀	紉	紇	約	紆	缸	美	羿	毫	
AD40	IBM	53A3	53A4	53A5	53A6	53A7	53A8	53A9	53AA	53AB	53AC	53AD	53AE	53AF	53B0	53B1	53B2
	Char.	耐	耍	崙	耶	胖	胥	胚	胃	胃	背	胡	胛	胎	胞	胤	胝
AD50	IBM	53B3	53B4	53B5	53B6	53B7	53B8	53B9	53BA	53BB	53BC	53BD	53BE	53BF	53C0	53C1	53C2
	Char.	致	舫	苧	范	茅	苣	苛	苦	茄	若	茂	茱	苻	苗	英	茁
AD60	IBM	53C3	53C4	53C5	53C6	53C7	53C8	53C9	53CA	53CB	53CC	53CD	53CE	53CF	53D0	53D1	53D2
	Char.	苜	苔	苑	苞	蒂	苟	笨	茆	虐	虹	虻	虺	衍	衫	耍	舫
AD70	IBM	53D3	53D4	53D5	53D6	53D7	53D8	53D9	53DA	53DB	53DC	53DD	53DE	53DF	53E0	53E1	
	Char.	計	訂	訃	貞	負	赴	越	叭	軍	軌	述	迦	迢	迪	迴	
ADA0	IBM		53E2	53E3	53E4	53E5	53E6	53E7	53E8	53E9	53EA	53EB	53EC	53ED	53EE	53EF	53F0
	Char.		迭	迫	迤	迨	郊	郎	郁	郤	曾	酌	重	問	限	陋	陌
ADB0	IBM	53F1	53F2	53F3	53F4	53F5	53F6	53F7	53F8	53F9	53FA	53FB	53FC	53FD	5441	5442	5443
	Char.	降	面	革	韋	韭	音	頁	風	飛	食	首	香	乘	毫	倌	倍
ADC0	IBM	5444	5445	5446	5447	5448	5449	544A	544B	544C	544D	544E	544F	5450	5451	5452	5453
	Char.	倣	俯	倦	控	俸	倩	倅	倆	值	借	倚	倒	們	俺	俚	偃
ADD0	IBM	5454	5455	5456	5457	5458	5459	545A	545B	545C	545D	545E	545F	5460	5461	5462	5463
	Char.	倨	俱	倡	個	候	倘	俳	修	倭	倪	俾	倫	倉	兼	冤	冥

Table B-4 Big5 à IBM Conversion Table (continued)

Big5		+ 0	+ 1	+ 2	+ 3	+ 4	+ 5	+ 6	+ 7	+ 8	+ 9	+ A	+ B	+ C	+ D	+ E	+ F
ADE0	IBM	5464	5465	5466	5467	5468	5469	546A	546B	546C	546D	546E	546F	5470	5471	5472	5473
	Char.	冢	凍	凌	准	洞	剖	剗	剔	剛	剝	匪	卿	原	厝	叟	哨
ADF0	IBM	5474	5475	5476	5477	5478	5479	547A	547B	547C	547D	547E	547F	5481	5482	5483	
	Char.	唐	噶	噲	哼	哥	哲	峻	哺	唔	哩	哭	員	唉	哮	哪	
AE40	IBM	5484	5485	5486	5487	5488	5489	548A	548B	548C	548D	548E	548F	5490	5491	5492	5493
	Char.	哦	唧	唇	哽	唏	圃	園	埂	埔	埋	埃	墳	夏	套	奘	奚
AE50	IBM	5494	5495	5496	5497	5498	5499	549A	549B	549C	549D	549E	549F	54A0	54A1	54A2	54A3
	Char.	娑	娘	娜	娟	娛	媿	姬	娠	娣	婉	娥	媪	娉	孫	尪	宰
AE60	IBM	54A4	54A5	54A6	54A7	54A8	54A9	54AA	54AB	54AC	54AD	54AE	54AF	54B0	54B1	54B2	54B3
	Char.	害	冢	宴	宮	宵	容	宸	射	屑	展	屨	峭	峽	峻	峪	峨
AE70	IBM	54B4	54B5	54B6	54B7	54B8	54B9	54BA	54BB	54BC	54BD	54BE	54BF	54C0	54C1	54C2	
	Char.	峰	島	崁	峴	差	席	師	庫	庭	座	弱	徒	徑	徐	恙	
AEA0	IBM		54C3	54C4	54C5	54C6	54C7	54C8	54C9	54CA	54CB	54CC	54CD	54CE	54CF	54D0	54D1
	Char.		恣	恥	恐	恕	恭	恩	息	悄	悟	悚	悍	悔	悌	悅	悖
AEBO	IBM	54D2	54D3	54D4	54D5	54D6	54D7	54D8	54D9	54DA	54DB	54DC	54DD	54DE	54DF	54E0	54E1
	Char.	扇	拳	掣	拿	揜	挾	振	捕	拑	捆	捏	捉	挺	捐	挽	挪
AECO	IBM	54E2	54E3	54E4	54E5	54E6	54E7	54E8	54E9	54EA	54EB	54EC	54ED	54EE	54EF	54F0	54F1
	Char.	挫	挨	捍	捌	效	敕	料	旁	旅	時	晉	晏	晃	晒	响	咍
AEDO	IBM	54F2	54F3	54F4	54F5	54F6	54F7	54F8	54F9	54FA	54FB	54FC	54FD	5541	5542	5543	5544
	Char.	晁	書	朔	朕	朗	校	核	案	框	桓	根	桂	桔	栩	梳	栗
AEE0	IBM	5545	5546	5547	5548	5549	554A	554B	554C	554D	554E	554F	5550	5551	5552	5553	5554
	Char.	桌	桑	栽	柴	桐	桀	格	桃	株	桅	栓	移	桁	殊	殉	殷
AEF0	IBM	5555	5556	5557	5558	5559	555A	555B	555C	555D	555E	555F	5560	5561	5562	5563	
	Char.	氣	氧	氫	氬	氦	泰	浪	涕	消	涇	浦	漫	海	浙	涓	

Table B-4 Big5 à IBM Conversion Table (continued)

Big5		+ 0	+ 1	+ 2	+ 3	+ 4	+ 5	+ 6	+ 7	+ 8	+ 9	+ A	+ B	+ C	+ D	+ E	+ F
AF40	IBM	5564	5565	5566	5567	5568	5569	556A	556B	556C	556D	556E	556F	5570	5571	5572	5573
	Char.	漚	涉	浮	浚	浴	浩	涌	忍	浹	涅	滉	滂	焯	烘	烤	烙
AF50	IBM	5574	5575	5576	5577	5578	5579	557A	557B	557C	557D	557E	557F	5581	5582	5583	5584
	Char.	烈	烏	爹	特	狼	狹	狽	狸	狷	玆	班	琉	珮	珠	珪	珞
AF60	IBM	5585	5586	5587	5588	5589	558A	558B	558C	558D	558E	558F	5590	5591	5592	5593	5594
	Char.	畔	畝	畜	眷	留	疾	病	症	疲	疖	疽	疼	疹	痂	疽	皯
AF70	IBM	5595	5596	5597	5598	5599	559A	559B	559C	559D	559E	559F	55A0	55A1	55A2	55A3	
	Char.	炮	益	盍	盍	眩	真	眠	眨	矩	碑	砧	砸	砒	破	碑	
AFA0	IBM		55A4	55A5	55A6	55A7	55A8	55A9	55AA	55AB	55AC	55A D	55AE	55AF	55B0	55B1	55B2
	Char.		砥	砥	租	砗	砲	祕	祐	祠	崇	祖	神	祝	祇	祚	秤
AFB0	IBM	55B3	55B4	55B5	55B6	55B7	55B8	55B9	55BA	55BB	55BC	55B D	55BE	55BF	55C0	55C1	55C2
	Char.	秣	秧	租	秦	秩	秘	窄	竊	站	筵	笑	粉	紡	紗	紋	素
AFC0	IBM	55C3	55C4	55C5	55C6	55C7	55C8	55C9	55CA	55CB	55CC	55C D	55CE	55CF	55D0	55D1	55D2
	Char.	素	素	純	紐	紕	級	紘	納	紙	紛	缺	罟	羔	翅	翁	耆
AFD0	IBM	55D3	55D4	55D5	55D6	55D7	55D8	55D9	55DA	55DB	55DC	55D D	55D E	55DF	55E0	55E1	55E2
	Char.	耘	耕	耙	耗	耽	耿	肫	脂	胰	脅	胭	胴	脆	胸	膈	脈
AFE0	IBM	55E3	55E4	55E5	55E6	55E7	55E8	55E9	55EA	55EB	55EC	55ED	55EE	55EF	55F0	55F1	55F2
	Char.	能	脊	胼	膊	臭	臬	昏	舐	航	舫	舩	般	芻	茫	荒	荔
AFF0	IBM	55F3	55F4	55F5	55F6	55F7	55F8	55F9	55FA	55FB	55FC	55FD	5641	5642	5643	5644	
	Char.	荊	茸	荐	草	茵	茵	荏	茲	茹	荼	茗	荀	茱	茨	荃	
B040	IBM	5645	5646	5647	5648	5649	564A	564B	564C	564D	564E	564F	5650	5651	5652	5653	5654
	Char.	虔	蚊	蚪	蚓	蚤	蚩	蚌	蚣	蚱	衰	衷	袁	袂	衽	祇	記

Table B-4 Big5 à IBM Conversion Table (continued)

Big5		+ 0	+ 1	+ 2	+ 3	+ 4	+ 5	+ 6	+ 7	+ 8	+ 9	+ A	+ B	+ C	+ D	+ E	+ F
B050	IBM	5655	5656	5657	5658	5659	565A	565B	565C	565D	565E	565F	5660	5661	5662	5663	5664
	Char.	訐	討	訶	訕	訕	託	訓	訖	訐	訑	豈	豺	豹	財	貢	起
B060	IBM	5665	5666	5667	5668	5669	566A	566B	566C	566D	566E	566F	5670	5671	5672	5673	5674
	Char.	躬	軒	軻	軌	辱	送	逆	迷	退	迺	迴	逃	追	逅	迸	邕
B070	IBM	5675	5676	5677	5678	5679	567A	567B	567C	567D	567E	567F	5681	5682	5683	5684	
	Char.	郡	郝	郢	酒	配	酌	釘	針	劍	釜	針	閃	院	陣	陡	
BOA0	IBM		5685	5686	5687	5688	5689	568A	568B	568C	568D	568E	568F	5690	5691	5692	5693
	Char.		陞	陝	除	陘	陞	隻	飢	馬	骨	高	鬥	鬲	鬼	乾	僭
BOB0	IBM	5694	5695	5696	5697	5698	5699	569A	569B	569C	569D	569E	569F	56A0	56A1	56A2	56A3
	Char.	偽	停	假	僂	僂	做	偉	健	偶	儂	借	偵	側	偷	偏	倏
BOC0	IBM	56A4	56A5	56A6	56A7	56A8	56A9	56AA	56AB	56AC	56AD	56AE	56AF	56B0	56B1	56B2	56B3
	Char.	儗	儗	兜	冕	鳳	剪	副	勒	務	勤	動	匐	匏	匙	匿	區
BOD0	IBM	56B4	56B5	56B6	56B7	56B8	56B9	56BA	56BB	56BC	56BD	56BE	56BF	56C0	56C1	56C2	56C3
	Char.	區	參	曼	商	啲	啦	啄	啞	啡	啃	啊	唱	啖	問	啣	唯
BOE0	IBM	56C4	56C5	56C6	56C7	56C8	56C9	56CA	56CB	56CC	56CD	56CE	56CF	56D0	56D1	56D2	56D3
	Char.	啤	唸	售	噉	唬	啣	啣	啣	啣	圈	國	圍	域	堅	聖	堆
BOF0	IBM	56D4	56D5	56D6	56D7	56D8	56D9	56DA	56DB	56DC	56DD	56DE	56DF	56E0	56E1	56E2	
	Char.	埠	埠	基	堂	堵	執	培	夠	奢	娶	妻	婉	婦	婪	嫻	
B140	IBM	56E3	56E4	56E5	56E6	56E7	56E8	56E9	56EA	56EB	56EC	56ED	56EE	56EF	56F0	56F1	56F2
	Char.	娼	婢	婚	婆	婁	孰	寇	寅	寄	寂	宿	密	尉	專	將	屠
B150	IBM	56F3	56F4	56F5	56F6	56F7	56F8	56F9	56FA	56FB	56FC	56FD	5741	5742	5743	5744	5745
	Char.	屨	扉	崇	崆	崎	崛	崖	崢	崑	崩	崔	崑	崑	崑	崑	巢

Table B-4 Big5 à IBM Conversion Table (continued)

Big5		+ 0	+ 1	+ 2	+ 3	+ 4	+ 5	+ 6	+ 7	+ 8	+ 9	+ A	+ B	+ C	+ D	+ E	+ F
B160	IBM	5746	5747	5748	5749	574A	574B	574C	574D	574E	574F	5750	5751	5752	5753	5754	5755
	Char.	常	帶	帳	帷	康	庸	庶	庵	庾	張	強	彗	彬	彩	彤	得
B170	IBM	5756	5757	5758	5759	575A	575B	575C	575D	575E	575F	5760	5761	5762	5763	5764	
	Char.	徙	從	徘	御	徠	徇	憑	患	悉	悠	您	惋	悴	怙	悽	
B1A0	IBM		5765	5766	5767	5768	5769	576A	576B	576C	576D	576E	576F	5770	5771	5772	5773
	Char.		情	悻	悵	惜	悼	惘	惕	惆	惟	悸	惚	悼	戚	戛	屨
B1B0	IBM	5774	5775	5776	5777	5778	5779	577A	577B	577C	577D	577E	577F	5781	5782	5783	5784
	Char.	掠	控	捲	掖	探	接	捷	捧	掘	措	捱	掩	掉	掃	掛	捫
B1C0	IBM	5785	5786	5787	5788	5789	578A	578B	578C	578D	578E	578F	5790	5791	5792	5793	5794
	Char.	推	掄	授	掙	採	掬	排	掬	掀	捻	捩	捨	捺	敝	赦	救
B1D0	IBM	5795	5796	5797	5798	5799	579A	579B	579C	579D	579E	579F	57A0	57A1	57A2	57A3	57A4
	Char.	教	敗	啟	敏	敘	敕	敵	斜	斛	斬	族	旋	旌	旒	晝	晚
B1E0	IBM	57A5	57A6	57A7	57A8	57A9	57AA	57AB	57AC	57AD	57AE	57AF	57B0	57B1	57B2	57B3	57B4
	Char.	晤	晨	晦	晞	曹	昴	望	梁	梯	梢	梓	梵	榭	桶	樞	梧
B1F0	IBM	57B5	57B6	57B7	57B8	57B9	57BA	57BB	57BC	57BD	57BE	57BF	57C0	57C1	57C2	57C3	
	Char.	梗	械	挺	棄	梭	榔	梅	樞	條	梨	梟	梲	棟	欲	殺	
B240	IBM	57C4	57C5	57C6	57C7	57C8	57C9	57CA	57CB	57CC	57CD	57CE	57CF	57D0	57D1	57D2	57D3
	Char.	毫	毳	氫	涎	涼	淳	淙	液	淡	淌	淤	添	淺	清	淇	淋
B250	IBM	57D4	57D5	57D6	57D7	57D8	57D9	57DA	57DB	57DC	57DD	57DE	57DF	57E0	57E1	57E2	57E3
	Char.	涯	淑	澗	淞	淹	涸	混	淵	浙	淒	渚	涵	淚	淫	淘	淪
B260	IBM	57E4	57E5	57E6	57E7	57E8	57E9	57EA	57EB	57EC	57ED	57EE	57EF	57F0	57F1	57F2	57F3
	Char.	深	淮	淨	淆	淄	浩	淬	涿	淦	烹	焉	焊	烽	烯	爽	牽
B270	IBM	57F4	57F5	57F6	57F7	57F8	57F9	57FA	57FB	57FC	57FD	5841	5842	5843	5844	5845	
	Char.	犁	猜	猛	猖	獯	猙	率	琅	瑯	球	理	現	琍	瓠	瓶	

Table B-4 Big5 à IBM Conversion Table (continued)

Big5		+ 0	+ 1	+ 2	+ 3	+ 4	+ 5	+ 6	+ 7	+ 8	+ 9	+ A	+ B	+ C	+ D	+ E	+ F
B2A0	IBM		5846	5847	5848	5849	584A	584B	584C	584D	584E	584F	5850	5851	5852	5853	5854
	Char.		瓷	甜	產	略	畦	畢	異	疏	痔	痕	疵	痊	瘻	皎	盃
B2B0	IBM	5855	5856	5857	5858	5859	585A	585B	585C	585D	585E	585F	5860	5861	5862	5863	5864
	Char.	盒	盛	眷	厭	眼	睚	眸	眺	疏	殊	劓	祥	票	祭	移	窒
B2C0	IBM	5865	5866	5867	5868	5869	586A	586B	586C	586D	586E	586F	5870	5871	5872	5873	5874
	Char.	窶	笠	笨	笛	第	符	笙	筈	竿	粒	粗	粕	絆	紘	統	紮
B2D0	IBM	5875	5876	5877	5878	5879	587A	587B	587C	587D	587E	587F	5881	5882	5883	5884	5885
	Char.	紹	縛	紕	細	紳	組	累	終	繼	紘	鉢	羞	矜	翌	翎	習
B2E0	IBM	5886	5887	5888	5889	588A	588B	588C	588D	588E	588F	5890	5891	5892	5893	5894	5895
	Char.	耜	聊	聆	脯	脗	脣	脫	脩	脛	脈	春	舵	舷	舶	船	莎
B2F0	IBM	5896	5897	5898	5899	589A	589B	589C	589D	589E	589F	58A0	58A1	58A2	58A3	58A4	
	Char.	莞	莘	莘	莢	莖	莽	莫	莒	莊	莓	莉	莠	荷	荻	荼	
B340	IBM	58A5	58A6	58A7	58A8	58A9	58AA	58AB	58AC	58AD	58AE	58AF	58B0	58B1	58B2	58B3	58B4
	Char.	莆	莧	處	彪	蛇	蛙	蚶	蛄	蚵	蛆	蛋	蚱	蚯	蛉	術	衰
B350	IBM	58B5	58B6	58B7	58B8	58B9	58BA	58BB	58BC	58BD	58BE	58BF	58C0	58C1	58C2	58C3	58C4
	Char.	袈	被	袒	袖	袍	袋	覓	規	訪	訝	訣	訥	許	設	訟	訛
B360	IBM	58C5	58C6	58C7	58C8	58C9	58CA	58CB	58CC	58CD	58CE	58CF	58D0	58D1	58D2	58D3	58D4
	Char.	訢	鼓	豚	販	責	貴	貨	貪	貧	赧	赦	趾	跌	輓	軟	這
B370	IBM	58D5	58D6	58D7	58D8	58D9	58DA	58DB	58DC	58DD	58DE	58DF	58E0	58E1	58E2	58E3	
	Char.	逍	通	逗	連	速	逝	逐	逕	逞	造	透	逢	遯	逛	途	
B3A0	IBM		58E4	58E5	58E6	58E7	58E8	58E9	58EA	58EB	58EC	58ED	58EE	58EF	58F0	58F1	58F2
	Char.		郇	郭	都	醜	野	釵	釳	鈞	釧	釨	釩	閉	陪	陵	陳
B3B0	IBM	58F3	58F4	58F5	58F6	58F7	58F8	58F9	58FA	58FB	58FC	58FD	5941	5942	5943	5944	5945
	Char.	陸	陰	啤	陶	陷	陘	雀	雪	雩	章	竟	頂	頃	魚	鳥	鹵

Table B-4 Big5 à IBM Conversion Table (continued)

Big5		+ 0	+ 1	+ 2	+ 3	+ 4	+ 5	+ 6	+ 7	+ 8	+ 9	+ A	+ B	+ C	+ D	+ E	+ F
B3C0	IBM	5946	5947	5948	5949	594A	594B	594C	594D	594E	594F	5950	5951	5952	5953	5954	5955
	Char.	鹿	麥	麻	傢	傍	傅	備	傑	傀	僉	傘	傲	最	凱	割	剷
B3D0	IBM	5956	5957	5958	5959	595A	595B	595C	595D	595E	595F	5960	5961	5962	5963	5964	5965
	Char.	創	剩	勞	勝	勛	博	厥	營	喀	喧	啼	喊	喝	喘	喂	喜
B3E0	IBM	5966	5967	5968	5969	596A	596B	596C	596D	596E	596F	5970	5971	5972	5973	5974	5975
	Char.	喪	喔	喇	喋	喃	喳	單	喟	唾	啣	喚	喻	喬	喱	嗽	喉
B3F0	IBM	5976	5977	5978	5979	597A	597B	597C	597D	597E	597F	5981	5982	5983	5984	5985	
	Char.	喫	喙	圍	堯	堪	場	堤	堰	報	堡	塢	堠	壹	壺	奠	
B440	IBM	5986	5987	5988	5989	598A	598B	598C	598D	598E	598F	5990	5991	5992	5993	5994	5995
	Char.	婷	媚	孀	媒	媛	媯	孳	孱	寒	富	寓	寐	尊	尋	就	嵌
B450	IBM	5996	5997	5998	5999	599A	599B	599C	599D	599E	599F	59A0	59A1	59A2	59A3	59A4	59A5
	Char.	嵐	巖	嵒	巽	幅	帽	幘	幃	幾	廊	廁	廂	廐	粥	彭	復
B460	IBM	59A6	59A7	59A8	59A9	59AA	59AB	59AC	59AD	59AE	59AF	59B0	59B1	59B2	59B3	59B4	59B5
	Char.	循	徨	惑	惡	悲	悶	惠	愜	愣	惝	愕	情	惻	惴	慨	惱
B470	IBM	59B6	59B7	59B8	59B9	59BA	59BB	59BC	59BD	59BE	59BF	59C0	59C1	59C2	59C3	59C4	
	Char.	復	惶	愉	愀	悒	戟	扉	掣	掌	描	揀	揩	揉	揆	揆	
B4A0	IBM		59C5	59C6	59C7	59C8	59C9	59CA	59CB	59CC	59CD	59CE	59CF	59D0	59D1	59D2	59D3
	Char.		插	揣	提	握	揖	揭	揮	捶	援	揪	換	摒	揚	揅	敝
B4B0	IBM	59D4	59D5	59D6	59D7	59D8	59D9	59DA	59DB	59DC	59DD	59DE	59DF	59E0	59E1	59E2	59E3
	Char.	敦	敢	散	斑	斐	斯	普	晰	晴	晶	景	暑	智	瞭	晷	曾
B4C0	IBM	59E4	59E5	59E6	59E7	59E8	59E9	59EA	59EB	59EC	59ED	59EE	59EF	59F0	59F1	59F2	59F3
	Char.	替	期	朝	棺	棕	棠	棘	棗	椅	棟	棵	森	棧	棹	棒	棲
B4D0	IBM	59F4	59F5	59F6	59F7	59F8	59F9	59FA	59FB	59FC	59FD	5A41	5A42	5A43	5A44	5A45	5A46
	Char.	棣	棋	棍	植	椒	椎	棉	棚	楮	蔡	款	欺	欽	殘	殖	殼

Table B-4 Big5 à IBM Conversion Table (continued)

Big5		+ 0	+ 1	+ 2	+ 3	+ 4	+ 5	+ 6	+ 7	+ 8	+ 9	+ A	+ B	+ C	+ D	+ E	+ F
B4E0	IBM	5A47	5A48	5A49	5A4A	5A4B	5A4C	5A4D	5A4E	5A4F	5A50	5A51	5A52	5A53	5A54	5A55	5A56
	Char.	毯	氫	氫	氫	港	游	湔	渡	渲	湧	湊	渠	渥	渣	減	湛
B4F0	IBM	5A57	5A58	5A59	5A5A	5A5B	5A5C	5A5D	5A5E	5A5F	5A60	5A61	5A62	5A63	5A64	5A65	
	Char.	湘	渤	湖	湮	渭	渦	湯	渴	湍	渺	測	湃	渝	渾	滋	
B540	IBM	5A66	5A67	5A68	5A69	5A6A	5A6B	5A6C	5A6D	5A6E	5A6F	5A70	5A71	5A72	5A73	5A74	5A75
	Char.	漑	渙	灑	滑	涓	湲	湟	湮	焔	焚	焦	焰	無	然	煮	焜
B550	IBM	5A76	5A77	5A78	5A79	5A7A	5A7B	5A7C	5A7D	5A7E	5A7F	5A81	5A82	5A83	5A84	5A85	5A86
	Char.	牌	椅	犀	猶	猥	猴	猩	玞	琪	琳	琢	琥	琵琶	琴	琯	
B560	IBM	5A87	5A88	5A89	5A8A	5A8B	5A8C	5A8D	5A8E	5A8F	5A90	5A91	5A92	5A93	5A94	5A95	5A96
	Char.	琛	琦	琨	甥	甦	畫	番	痢	痛	痣	瘻	痘	痞	痲	登	發
B570	IBM	5A97	5A98	5A99	5A9A	5A9B	5A9C	5A9D	5A9E	5A9F	5AA0	5AA1	5AA2	5AA3	5AA4	5AA5	
	Char.	皖	皓	皴	盜	晒	短	硝	硬	硯	稍	稗	程	稅	稀	窘	
B5A0	IBM		5AA6	5AA7	5AA8	5AA9	5AAA	5AAB	5AAC	5AAD	5AAE	5AAF	5AB0	5AB1	5AB2	5AB3	5AB4
	Char.		窗	窳	童	竣	等	策	筆	筐	筒	答	筍	筋	筏	筑	粟
B5B0	IBM	5AB5	5AB6	5AB7	5AB8	5AB9	5ABA	5ABB	5ABC	5ABD	5ABE	5ABF	5AC0	5AC1	5AC2	5AC3	5AC4
	Char.	粥	絞	結	絨	絕	紫	架	絲	絡	給	絢	經	絳	善	翔	翕
B5C0	IBM	5AC5	5AC6	5AC7	5AC8	5AC9	5ACA	5ACB	5ACC	5ACD	5ACE	5ACF	5AD0	5AD1	5AD2	5AD3	5AD4
	Char.	壘	聒	肅	腕	腔	腋	腑	腎	脹	腆	脾	膾	腓	腴	舒	舜
B5D0	IBM	5AD5	5AD6	5AD7	5AD8	5AD9	5ADA	5ADB	5ADC	5ADD	5ADE	5ADF	5AE0	5AE1	5AE2	5AE3	5AE4
	Char.	菩	萃	菸	萍	菠	菅	萋	菁	華	菱	菴	著	萊	菰	萌	菌
B5E0	IBM	5AE5	5AE6	5AE7	5AE8	5AE9	5AEA	5AEB	5AEC	5AED	5AEE	5AEF	5AF0	5AF1	5AF2	5AF3	5AF4
	Char.	菽	菲	菊	萸	菱	荀	菜	蕘	蕈	蕘	虛	蛟	蛙	蛭	蛔	蛛
B5F0	IBM	5AF5	5AF6	5AF7	5AF8	5AF9	5AFA	5AFB	5AFC	5AFD	5B41	5B42	5B43	5B44	5B45	5B46	
	Char.	蛤	蝸	蛞	街	裁	裂	袱	罩	視	註	詠	評	詞	証	詰	

Table B-4 Big5 à IBM Conversion Table (continued)

Big5		+ 0	+ 1	+ 2	+ 3	+ 4	+ 5	+ 6	+ 7	+ 8	+ 9	+ A	+ B	+ C	+ D	+ E	+ F
B640	IBM	5B47	5B48	5B49	5B4A	5B4B	5B4C	5B4D	5B4E	5B4F	5B50	5B51	5B52	5B53	5B54	5B55	5B56
	Char.	詔	詛	詐	詆	訴	診	訶	詖	象	貂	貯	貼	貳	貽	賁	費
B650	IBM	5B57	5B58	5B59	5B5A	5B5B	5B5C	5B5D	5B5E	5B5F	5B60	5B61	5B62	5B63	5B64	5B65	5B66
	Char.	賀	賁	賈	眨	賈	貸	越	超	趁	跔	距	跋	跚	跑	跌	跛
B660	IBM	5B67	5B68	5B69	5B6A	5B6B	5B6C	5B6D	5B6E	5B6F	5B70	5B71	5B72	5B73	5B74	5B75	5B76
	Char.	跲	軻	軸	軼	辜	逮	遼	週	逸	進	透	鄂	郵	鄉	鄗	酣
B670	IBM	5B77	5B78	5B79	5B7A	5B7B	5B7C	5B7D	5B7E	5B7F	5B81	5B82	5B83	5B84	5B85	5B86	
	Char.	酥	量	鈔	鈕	鈣	鈉	鈞	鈍	鈐	鈇	鈈	閔	閏	開	閑	
B6A0	IBM		5B87	5B88	5B89	5B8A	5B8B	5B8C	5B8D	5B8E	5B8F	5B90	5B91	5B92	5B93	5B94	5B95
	Char.		間	閒	閔	隊	階	隋	陽	隅	隆	隍	陞	隄	雁	雅	雄
B6B0	IBM	5B96	5B97	5B98	5B99	5B9A	5B9B	5B9C	5B9D	5B9E	5B9F	5BA0	5BA1	5BA2	5BA3	5BA4	5BA5
	Char.	集	雇	雯	雲	韌	項	順	須	飡	飪	飯	餛	飲	飭	馮	馭
B6C0	IBM	5BA6	5BA7	5BA8	5BA9	5BAA	5BAB	5BAC	5BAD	5BAE	5BAF	5BB0	5BB1	5BB2	5BB3	5BB4	5BB5
	Char.	黃	黍	黑	亂	傭	債	傲	傳	僅	傾	催	傷	傻	德	僂	剿
B6D0	IBM	5BB6	5BB7	5BB8	5BB9	5BBA	5BBB	5BBC	5BBD	5BBE	5BBF	5BC0	5BC1	5BC2	5BC3	5BC4	5BC5
	Char.	劇	剝	募	勳	勳	勢	勳	匯	嗟	噉	噪	唳	嗎	嗜	膏	嗑
B6E0	IBM	5BC6	5BC7	5BC8	5BC9	5BCA	5BCB	5BCC	5BCD	5BCE	5BCF	5BD0	5BD1	5BD2	5BD3	5BD4	5BD5
	Char.	嗣	嗑	噁	嗚	喻	嗅	噲	嗶	嘍	園	圓	塞	塑	塘	塗	塚
B6F0	IBM	5BD6	5BD7	5BD8	5BD9	5BDA	5BDB	5BDC	5BDD	5BDE	5BDF	5BE0	5BE1	5BE2	5BE3	5BE4	
	Char.	塔	填	塌	塹	塊	塢	塢	塢	塢	塢	塢	塢	塢	塢	塢	
B740	IBM	5BE5	5BE6	5BE7	5BE8	5BE9	5BEA	5BEB	5BEC	5BED	5BEE	5BEF	5BF0	5BF1	5BF2	5BF3	5BF4
	Char.	媳	嫂	媳	嵩	嵯	幌	幹	廉	廈	弑	梟	徬	微	愚	意	慈
B750	IBM	5BF5	5BF6	5BF7	5BF8	5BF9	5BFA	5BFB	5BFC	5BFD	5C41	5C42	5C43	5C44	5C45	5C46	5C47
	Char.	感	想	愛	惹	愁	愈	慎	慌	慄	慍	慍	愴	愧	愍	愆	愷

Table B-4 Big5 à IBM Conversion Table (continued)

Big5		+ 0	+ 1	+ 2	+ 3	+ 4	+ 5	+ 6	+ 7	+ 8	+ 9	+ A	+ B	+ C	+ D	+ E	+ F
B760	IBM	5C48	5C49	5C4A	5C4B	5C4C	5C4D	5C4E	5C4F	5C50	5C51	5C52	5C53	5C54	5C55	5C56	5C57
	Char.	戡	戢	搓	搾	搞	搪	搭	搽	搬	搏	搜	搔	損	搶	搖	搗
B770	IBM	5C58	5C59	5C5A	5C5B	5C5C	5C5D	5C5E	5C5F	5C60	5C61	5C62	5C63	5C64	5C65	5C66	
	Char.	構	敬	斟	新	暗	暉	暇	暈	暖	喧	喝	喝	會	榔	業	
B7A0	IBM		5C67	5C68	5C69	5C6A	5C6B	5C6C	5C6D	5C6E	5C6F	5C70	5C71	5C72	5C73	5C74	5C75
	Char.		楚	楷	楠	楔	極	椰	概	楊	楨	楫	楞	楓	楹	榆	棟
B7B0	IBM	5C76	5C77	5C78	5C79	5C7A	5C7B	5C7C	5C7D	5C7E	5C7F	5C81	5C82	5C83	5C84	5C85	5C86
	Char.	楣	楷	歇	歲	毀	殿	毓	鍵	溢	溯	滓	溶	滂	源	溝	滇
B7C0	IBM	5C87	5C88	5C89	5C8A	5C8B	5C8C	5C8D	5C8E	5C8F	5C90	5C91	5C92	5C93	5C94	5C95	5C96
	Char.	滅	溥	溘	溼	溺	溫	滑	準	溜	滄	滔	溪	溧	溴	煎	煙
B7D0	IBM	5C97	5C98	5C99	5C9A	5C9B	5C9C	5C9D	5C9E	5C9F	5CA0	5CA1	5CA2	5CA3	5CA4	5CA5	5CA6
	Char.	煩	煤	煉	照	煜	煬	煦	煌	煥	煞	煨	煨	煨	爺	牒	猷
B7E0	IBM	5CA7	5CA8	5CA9	5CAA	5CAB	5CAC	5CAD	5CAE	5CAF	5CB0	5CB1	5CB2	5CB3	5CB4	5CB5	5CB6
	Char.	獅	猿	猾	瑯	瑚	瑕	瑟	瑞	瑁	瑋	璫	瑛	瑜	當	畸	痧
B7F0	IBM	5CB7	5CB8	5CB9	5CBA	5CBB	5CBC	5CBD	5CBE	5CBF	5CC0	5CC1	5CC2	5CC3	5CC4	5CC5	
	Char.	痰	瘁	癩	痲	痺	痿	痲	癩	藎	盟	睛	睫	睦	睽	督	
B840	IBM	5CC6	5CC7	5CC8	5CC9	5CCA	5CCB	5CCC	5CCD	5CCE	5CCF	5CD0	5CD1	5CD2	5CD3	5CD4	5CD5
	Char.	睹	睪	睬	睜	睥	睨	睽	矮	碎	碰	碗	碘	碌	礪	礪	碑
B850	IBM	5CD6	5CD7	5CD8	5CD9	5CDA	5CDB	5CDC	5CDD	5CDE	5CDF	5CE0	5CE1	5CE2	5CE3	5CE4	5CE5
	Char.	碓	磴	祺	祿	禁	萬	禽	稜	稚	稠	稔	稟	稞	窟	窠	篋
B860	IBM	5CE6	5CE7	5CE8	5CE9	5CEA	5CEB	5CEC	5CED	5CEE	5CEF	5CF0	5CF1	5CF2	5CF3	5CF4	5CF5
	Char.	節	筠	筮	筧	梁	粳	粵	經	絹	細	綁	綬	條	置	罩	罪

Table B-4 Big5 à IBM Conversion Table (continued)

Big5		+ 0	+ 1	+ 2	+ 3	+ 4	+ 5	+ 6	+ 7	+ 8	+ 9	+ A	+ B	+ C	+ D	+ E	+ F
B870	IBM	5CF6	5CF7	5CF8	5CF9	5CFA	5CFB	5CFC	5CFD	5D41	5D42	5D43	5D44	5D45	5D46	5D47	
	Char.	署	義	羨	群	聖	聘	肆	肆	隄	腰	腸	脛	腮	腳	腫	
B8A0	IBM		5D48	5D49	5D4A	5D4B	5D4C	5D4D	5D4E	5D4F	5D50	5D51	5D52	5D53	5D54	5D55	5D56
	Char.		腹	腺	腦	舅	艇	蒂	葦	落	萱	葵	葦	葫	葉	葬	葛
B8B0	IBM	5D57	5D58	5D59	5D5A	5D5B	5D5C	5D5D	5D5E	5D5F	5D60	5D61	5D62	5D63	5D64	5D65	5D66
	Char.	萼	蒿	葡	董	葩	葭	葆	虞	虞	號	蛹	蜓	蜈	蜚	蜀	蛾
B8C0	IBM	5D67	5D68	5D69	5D6A	5D6B	5D6C	5D6D	5D6E	5D6F	5D70	5D71	5D72	5D73	5D74	5D75	5D76
	Char.	蛻	蜂	蜃	蜆	蛭	衙	裝	裔	裙	補	裘	裝	裡	裊	裕	裒
B8D0	IBM	5D77	5D78	5D79	5D7A	5D7B	5D7C	5D7D	5D7E	5D7F	5D81	5D82	5D83	5D84	5D85	5D86	5D87
	Char.	規	解	詫	該	詳	試	詩	詰	誇	詼	詣	誠	話	誅	詭	詢
B8E0	IBM	5D88	5D89	5D8A	5D8B	5D8C	5D8D	5D8E	5D8F	5D90	5D91	5D92	5D93	5D94	5D95	5D96	5D97
	Char.	詮	詬	詹	諮	訾	訖	豢	豨	豨	賊	資	賈	賄	賞	賃	賂
B8F0	IBM	5D98	5D99	5D9A	5D9B	5D9C	5D9D	5D9E	5D9F	5DA0	5DA1	5DA2	5DA3	5DA4	5DA5	5DA6	
	Char.	賅	跡	跟	跨	路	跳	蹂	跪	跤	踣	躲	較	載	軾	輕	
B940	IBM	5DA7	5DA8	5DA9	5DAA	5DAB	5DAC	5DAD	5DAE	5DAF	5DB0	5DB1	5DB2	5DB3	5DB4	5DB5	5DB6
	Char.	辟	農	運	遊	道	遂	達	逼	違	遐	遇	遏	過	遍	違	逾
B950	IBM	5DB7	5DB8	5DB9	5DBA	5DBB	5DBC	5DBD	5DBE	5DBF	5DC0	5DC1	5DC2	5DC3	5DC4	5DC5	5DC6
	Char.	遁	鄒	鄒	酬	酪	酪	釉	鈷	鉗	鈇	鈇	鉀	鈾	鉛	鉈	鉤
B960	IBM	5DC7	5DC8	5DC9	5DCA	5DCB	5DCC	5DCD	5DCE	5DCF	5DD0	5DD1	5DD2	5DD3	5DD4	5DD5	5DD6
	Char.	鉈	鈴	鉉	鉍	鉅	鉞	鈿	鉗	閻	隘	隔	隕	雍	雋	雉	雉
B970	IBM	5DD7	5DD8	5DD9	5DDA	5ddb	5DDC	5DDD	5DDE	5DDF	5DE0	5DE1	5DE2	5DE3	5DE4	5DE5	
	Char.	雷	電	電	零	靖	靴	靶	預	頑	頓	項	頰	頰	飼	飴	
B9A0	IBM		5DE6	5DE7	5DE8	5DE9	5DEA	5DEB	5DEC	5DED	5DEE	5DEF	5DF0	5DF1	5DF2	5DF3	5DF4
	Char.		飽	飾	馳	馱	馴	髡	鳩	癘	鼎	鼓	鼠	僧	僮	僂	僂

Table B-4 Big5 à IBM Conversion Table (continued)

Big5		+ 0	+ 1	+ 2	+ 3	+ 4	+ 5	+ 6	+ 7	+ 8	+ 9	+ A	+ B	+ C	+ D	+ E	+ F
B9B0	IBM	5DF5	5DF6	5DF7	5DF8	5DF9	5DFA	5DFB	5DFC	5DFD	5E41	5E42	5E43	5E44	5E45	5E46	5E47
	Char.	僭	僚	僕	像	僑	僱	僕	僩	兢	凳	劃	刷	匱	厭	噉	啗
B9C0	IBM	5E48	5E49	5E4A	5E4B	5E4C	5E4D	5E4E	5E4F	5E50	5E51	5E52	5E53	5E54	5E55	5E56	5E57
	Char.	嘛	嘗	嗽	嘔	嘆	嘉	嘍	嘎	嗽	嘖	啣	嘈	嚙	啤	團	圖
B9D0	IBM	5E58	5E59	5E5A	5E5B	5E5C	5E5D	5E5E	5E5F	5E60	5E61	5E62	5E63	5E64	5E65	5E66	5E67
	Char.	塵	塾	境	墓	塾	墅	墅	埭	壽	夥	夢	夤	奪	窟	嫡	娣
B9E0	IBM	5E68	5E69	5E6A	5E6B	5E6C	5E6D	5E6E	5E6F	5E70	5E71	5E72	5E73	5E74	5E75	5E76	5E77
	Char.	嫩	嫗	嫖	嫖	媽	瞬	寞	寧	寡	寥	實	寨	寢	寤	察	對
B9F0	IBM	5E78	5E79	5E7A	5E7B	5E7C	5E7D	5E7E	5E7F	5E81	5E82	5E83	5E84	5E85	5E86	5E87	
	Char.	屢	嶄	嶇	幃	幣	幕	幘	幔	廊	廖	弊	弊	彰	徹	慫	
BA40	IBM	5E88	5E89	5E8A	5E8B	5E8C	5E8D	5E8E	5E8F	5E90	5E91	5E92	5E93	5E94	5E95	5E96	5E97
	Char.	愿	態	慷	慢	慣	慟	慚	慘	慵	截	撤	摘	摔	撤	摸	摟
BA50	IBM	5E98	5E99	5E9A	5E9B	5E9C	5E9D	5E9E	5E9F	5EA0	5EA1	5EA2	5EA3	5EA4	5EA5	5EA6	5EA7
	Char.	摺	摺	摧	攀	搥	摻	敲	幹	旗	旖	暢	暨	暝	榜	榨	榕
BA60	IBM	5EA8	5EA9	5EAA	5EAB	5EAC	5EAD	5EAE	5EAF	5EB0	5EB1	5EB2	5EB3	5EB4	5EB5	5EB6	5EB7
	Char.	槁	榮	禎	構	榛	榷	榻	榫	榴	槐	槍	榭	槌	榦	槩	榭
BA70	IBM	5EB8	5EB9	5EBA	5EBB	5EBC	5EBD	5EBE	5EBF	5EC0	5EC1	5EC2	5EC3	5EC4	5EC5	5EC6	
	Char.	歉	歌	氫	漳	演	滾	漓	滴	漩	漾	漠	漬	漏	漂	漢	
BAA0	IBM		5EC7	5EC8	5EC9	5ECA	5ECB	5ECC	5ECD	5ECE	5ECF	5ED0	5ED1	5ED2	5ED3	5ED4	5ED5
	Char.		滿	滯	漆	漱	漸	漲	漣	漕	漫	潔	澈	漪	瀉	漁	滲
BAB0	IBM	5ED6	5ED7	5ED8	5ED9	5EDA	5EDB	5EDC	5EDD	5EDE	5EDF	5EE0	5EE1	5EE2	5EE3	5EE4	5EE5
	Char.	滌	滷	熔	熙	煽	熊	熄	熒	爾	槁	犖	獄	獐	瑤	瑣	瑪
BAC0	IBM	5EE6	5EE7	5EE8	5EE9	5EEA	5EEB	5EEC	5EED	5EEE	5EEF	5EFO	5EF1	5EF2	5EF3	5EF4	5EF5
	Char.	瑰	瑤	甄	疑	瘡	瘍	癩	癩	癩	盡	監	瞄	睽	睿	睡	磁

Table B-4 Big5 à IBM Conversion Table (continued)

Big5		+ 0	+ 1	+ 2	+ 3	+ 4	+ 5	+ 6	+ 7	+ 8	+ 9	+ A	+ B	+ C	+ D	+ E	+ F
BAD0	IBM	5EF6	5EF7	5EF8	5EF9	5EFA	5EFB	5EFC	5EFD	5F41	5F42	5F43	5F44	5F45	5F46	5F47	5F48
	Char.	碟	碧	碳	碩	褐	禎	福	禍	種	稱	窪	窩	竭	端	管	箕
BAE0	IBM	5F49	5F4A	5F4B	5F4C	5F4D	5F4E	5F4F	5F50	5F51	5F52	5F53	5F54	5F55	5F56	5F57	5F58
	Char.	篋	筵	算	箱	箔	箏	箸	筍	箏	粹	粽	精	綻	縮	綜	綽
BAF0	IBM	5F59	5F5A	5F5B	5F5C	5F5D	5F5E	5F5F	5F60	5F61	5F62	5F63	5F64	5F65	5F66	5F67	
	Char.	綾	綠	緊	綴	網	網	綺	綢	綿	綵	綸	維	緒	繼	綬	
BB40	IBM	5F68	5F69	5F6A	5F6B	5F6C	5F6D	5F6E	5F6F	5F70	5F71	5F72	5F73	5F74	5F75	5F76	5F77
	Char.	罰	翠	翡	翟	聞	聚	肇	腐	膀	膏	膈	膊	腿	膂	臧	臺
BB50	IBM	5F78	5F79	5F7A	5F7B	5F7C	5F7D	5F7E	5F7F	5F81	5F82	5F83	5F84	5F85	5F86	5F87	5F88
	Char.	與	舔	舞	魃	蓉	蒿	蓆	蓄	蒙	蒞	蒲	蒜	蓋	蒸	蒸	蓓
BB60	IBM	5F89	5F8A	5F8B	5F8C	5F8D	5F8E	5F8F	5F90	5F91	5F92	5F93	5F94	5F95	5F96	5F97	5F98
	Char.	蒐	蒼	蓑	蓊	蜿	蜜	蜻	蟻	蜥	蜴	蚰	蝕	蝮	蝮	裳	褂
BB70	IBM	5F99	5F9A	5F9B	5F9C	5F9D	5F9E	5F9F	5FA0	5FA1	5FA2	5FA3	5FA4	5FA5	5FA6	5FA7	
	Char.	裴	裹	裸	製	裨	褚	裯	誦	誌	語	誣	認	誠	誓	誤	
BBA0	IBM		5FA8	5FA9	5FAA	5FAB	5FAC	5FAD	5FAE	5FAF	5FB0	5FB1	5FB2	5FB3	5FB4	5FB5	5FB6
	Char.		說	詰	誨	誘	誑	誑	誦	豪	狸	貌	賈	賑	賒	赫	趙
BBB0	IBM	5FB7	5FB8	5FB9	5FBA	5FBB	5FBC	5FBD	5FBE	5FBF	5FC0	5FC1	5FC2	5FC3	5FC4	5FC5	5FC6
	Char.	趕	踟	輔	輒	輕	輓	辣	遠	邁	遜	遣	遙	遞	遞	逦	遛
BBC0	IBM	5FC7	5FC8	5FC9	5FCA	5FCB	5FCC	5FCD	5FCE	5FCF	5FD0	5FD1	5FD2	5FD3	5FD4	5FD5	5FD6
	Char.	鄙	鄙	鄴	薛	酸	酷	醜	餃	銀	銅	銘	銖	銘	銓	銜	鉸
BBD0	IBM	5FD7	5FD8	5FD9	5FDA	5FDB	5FDC	5FDD	5FDE	5FDF	5FE0	5FE1	5FE2	5FE3	5FE4	5FE5	5FE6
	Char.	鉸	銑	閔	閏	閏	閏	閏	閏	隙	障	際	雌	雒	需	鞞	鞅
BBE0	IBM	5FE7	5FE8	5FE9	5FEA	5FEB	5FEC	5FED	5FEE	5FEF	5FF0	5FF1	5FF2	5FF3	5FF4	5FF5	5FF6
	Char.	韶	頗	頌	颯	颯	餃	餅	餌	餉	駁	骹	骹	髦	魁	魂	鳴

Table B-4 Big5 à IBM Conversion Table (continued)

Big5		+ 0	+ 1	+ 2	+ 3	+ 4	+ 5	+ 6	+ 7	+ 8	+ 9	+ A	+ B	+ C	+ D	+ E	+ F
BBF0	IBM	5FF7	5FF8	5FF9	5FFA	5FFB	5FFC	5FFD	6041	6042	6043	6044	6045	6046	6047	6048	
	Char.	鳶	鳳	麼	鼻	齊	億	儀	僻	僵	價	儂	儉	儉	儉	凜	
BC40	IBM	6049	604A	604B	604C	604D	604E	604F	6050	6051	6052	6053	6054	6055	6056	6057	6058
	Char.	劇	劈	劉	劍	劊	總	厲	嘮	嘻	瞭	嘲	嘿	嘴	嘩	噓	噓
BC50	IBM	6059	605A	605B	605C	605D	605E	605F	6060	6061	6062	6063	6064	6065	6066	6067	6068
	Char.	嘖	噴	嘶	嘯	嘍	墀	墟	增	墳	墜	墮	墩	墻	爽	嬉	嫻
BC60	IBM	6069	606A	606B	606C	606D	606E	606F	6070	6071	6072	6073	6074	6075	6076	6077	6078
	Char.	嬋	嫵	嬌	嬌	寮	寬	審	寫	層	履	嶝	嶽	幢	幟	幡	廢
BC70	IBM	6079	607A	607B	607C	607D	607E	607F	6081	6082	6083	6084	6085	6086	6087	6088	
	Char.	廚	廟	廝	廣	廠	彈	影	德	徵	慶	慧	慮	慮	慕	憂	
BCA0	IBM		6089	608A	608B	608C	608D	608E	608F	6090	6091	6092	6093	6094	6095	6096	6097
	Char.		感	慰	愆	愆	懂	憐	憫	憎	憬	憚	憤	憔悴	憐	戮	摩
BCB0	IBM	6098	6099	609A	609B	609C	609D	609E	609F	60A0	60A1	60A2	60A3	60A4	60A5	60A6	60A7
	Char.	摯	摹	撞	撲	撈	撈	撰	撥	撓	撕	撩	撒	撮	播	撫	撚
BCC0	IBM	60A8	60A9	60AA	60AB	60AC	60AD	60AE	60AF	60B0	60B1	60B2	60B3	60B4	60B5	60B6	60B7
	Char.	攏	擲	擲	撤	敵	敷	敷	暮	暫	暴	暱	樣	樟	柳	椿	樞
BCD0	IBM	60B8	60B9	60BA	60BB	60BC	60BD	60BE	60BF	60C0	60C1	60C2	60C3	60C4	60C5	60C6	60C7
	Char.	標	槽	模	樓	樊	槳	樂	樅	械	樑	歐	歎	殤	毅	毆	漿
BCE0	IBM	60C8	60C9	60CA	60CB	60CC	60CD	60CE	60CF	60D0	60D1	60D2	60D3	60D4	60D5	60D6	60D7
	Char.	潼	澄	潑	潦	潔	澆	潭	潛	潛	潮	澎	潺	潰	潤	潤	潘
BCF0	IBM	60D8	60D9	60DA	60DB	60DC	60DD	60DE	60DF	60E0	60E1	60E2	60E3	60E4	60E5	60E6	
	Char.	滕	潯	瀕	渦	熟	熬	熱	熨	牖	犛	獎	獬	瑩	璋	璃	
BD40	IBM	60E7	60E8	60E9	60EA	60EB	60EC	60ED	60EE	60EF	60F0	60F1	60F2	60F3	60F4	60F5	60F6
	Char.	瑾	瑾	畿	瘠	瘡	瘡	瘡	瘦	瘡	癩	皴	皴	盤	瞎	瞇	瞇

Table B-4 Big5 à IBM Conversion Table (continued)

Big5		+ 0	+ 1	+ 2	+ 3	+ 4	+ 5	+ 6	+ 7	+ 8	+ 9	+ A	+ B	+ C	+ D	+ E	+ F
BD50	IBM	60F7	60F8	60F9	60FA	60FB	60FC	60FD	6141	6142	6143	6144	6145	6146	6147	6148	6149
	Char.	瞋	瞋	礎	磅	確	磊	碾	礪	碼	磬	稿	稼	穀	稽	稷	稻
BD60	IBM	614A	614B	614C	614D	614E	614F	6150	6151	6152	6153	6154	6155	6156	6157	6158	6159
	Char.	窳	窮	箭	箱	範	箴	篆	篇	篁	篁	篔	糊	締	練	緯	緻
BD70	IBM	615A	615B	615C	615D	615E	615F	6160	6161	6162	6163	6164	6165	6166	6167	6168	
	Char.	緘	緬	緝	編	緣	線	緞	緩	緹	緯	緲	緹	罵	罷	羯	
BDA0	IBM		6169	616A	616B	616C	616D	616E	616F	6170	6171	6172	6173	6174	6175	6176	6177
	Char.		翩	耦	膛	膜	膝	膠	膚	膘	蔗	蔽	蔚	蓮	蔬	蔭	蔓
BDB0	IBM	6178	6179	617A	617B	617C	617D	617E	617F	6181	6182	6183	6184	6185	6186	6187	6188
	Char.	蔑	蔣	蔡	荀	蓬	蔥	菹	菱	螂	蝴	蝶	蝠	蝦	蝸	蝨	蠅
BDC0	IBM	6189	618A	618B	618C	618D	618E	618F	6190	6191	6192	6193	6194	6195	6196	6197	6198
	Char.	蝗	蝻	蝻	衛	衝	褐	複	褒	褌	褌	褌	誼	諒	談	諄	誕
BDD0	IBM	6199	619A	619B	619C	619D	619E	619F	61A0	61A1	61A2	61A3	61A4	61A5	61A6	61A7	61A8
	Char.	請	諸	課	諉	諂	調	誰	論	諍	諍	誹	諛	詭	豎	豬	賠
BDE0	IBM	61A9	61AA	61AB	61AC	61AD	61AE	61AF	61B0	61B1	61B2	61B3	61B4	61B5	61B6	61B7	61B8
	Char.	賞	賦	賤	賤	賤	賤	賤	賤	賤	賤	賤	賤	賤	賤	賤	賤
BDF0	IBM	61B9	61BA	61BB	61BC	61BD	61BE	61BF	61C0	61C1	61C2	61C3	61C4	61C5	61C6	61C7	
	Char.	踢	踏	睬	脚	踉	踉	踉	輝	輻	輻	輻	輻	輻	輻	輻	
BE40	IBM	61C8	61C9	61CA	61CB	61CC	61CD	61CE	61CF	61D0	61D1	61D2	61D3	61D4	61D5	61D6	61D7
	Char.	鞦	適	遮	遼	遭	遷	鄰	鄭	鄧	鄧	醇	醉	醋	醃	鋅	銻
BE50	IBM	61D8	61D9	61DA	61DB	61DC	61DD	61DE	61DF	61E0	61E1	61E2	61E3	61E4	61E5	61E6	61E7
	Char.	銷	鋪	銜	鋤	鋁	銳	銼	鋒	鋇	鋇	鋇	閭	閱	霄	霆	震
BE60	IBM	61E8	61E9	61EA	61EB	61EC	61ED	61EE	61EF	61F0	61F1	61F2	61F3	61F4	61F5	61F6	61F7
	Char.	霉	靠	鞍	鞋	鞏	頤	頤	頤	廐	養	餒	餒	餘	駝	駐	駟

Table B-4 Big5 à IBM Conversion Table (continued)

Big5		+ 0	+ 1	+ 2	+ 3	+ 4	+ 5	+ 6	+ 7	+ 8	+ 9	+ A	+ B	+ C	+ D	+ E	+ F
BE70	IBM	61F8	61F9	61FA	61FB	61FC	61FD	6241	6242	6243	6244	6245	6246	6247	6248	6249	
	Char.	駁	駑	駑	駒	駙	黏	髮	髻	鬧	魅	魄	魷	魯	鳩	鴉	
BEA0	IBM		624A	624B	624C	624D	624E	624F	6250	6251	6252	6253	6254	6255	6256	6257	6258
	Char.		馱	麩	麾	黎	墨	齒	儒	儘	儔	債	儕	冀	冪	凝	劑
BEB0	IBM	6259	625A	625B	625C	625D	625E	625F	6260	6261	6262	6263	6264	6265	6266	6267	6268
	Char.	剝	動	噲	噫	噶	噩	噤	噸	噪	器	嘍	噓	噤	噉	噢	噶
BEC0	IBM	6269	626A	626B	626C	626D	626E	626F	6270	6271	6272	6273	6274	6275	6276	6277	6278
	Char.	壁	墾	壇	壘	奮	孃	羸	學	寰	導	彊	憲	憑	憩	憊	慄
BED0	IBM	6279	627A	627B	627C	627D	627E	627F	6281	6282	6283	6284	6285	6286	6287	6288	6289
	Char.	憶	憾	懊	懈	戰	擅	擁	擋	撻	撼	據	擄	擇	擗	操	撿
BEE0	IBM	628A	628B	628C	628D	628E	628F	6290	6291	6292	6293	6294	6295	6296	6297	6298	6299
	Char.	擒	擔	搥	整	曆	曉	暹	曄	曇	瞭	樽	樸	樺	橙	橫	橘
BEF0	IBM	629A	629B	629C	629D	629E	629F	62A0	62A1	62A2	62A3	62A4	62A5	62A6	62A7	62A8	
	Char.	樹	橄	橢	橡	橋	橿	樵	機	橈	欸	歷	髦	濂	澱	澡	
BF40	IBM	62A9	62AA	62AB	62AC	62AD	62AE	62AF	62B0	62B1	62B2	62B3	62B4	62B5	62B6	62B7	62B8
	Char.	濃	澤	濁	澧	澳	激	澹	澶	瀕	澗	濃	熾	熾	熾	燒	燈
BF50	IBM	62B9	62BA	62BB	62BC	62BD	62BE	62BF	62C0	62C1	62C2	62C3	62C4	62C5	62C6	62C7	62C8
	Char.	燕	熹	燎	燙	爛	燃	燄	獨	璜	璣	璘	璟	璞	瓢	甌	薑
BF60	IBM	62C9	62CA	62CB	62CC	62CD	62CE	62CF	62D0	62D1	62D2	62D3	62D4	62D5	62D6	62D7	62D8
	Char.	瘴	癩	癩	盧	盥	瞠	瞞	瞞	瞞	磨	磚	磬	磬	禦	積	穎
BF70	IBM	62D9	62DA	62DB	62DC	62DD	62DE	62DF	62E0	62E1	62E2	62E3	62E4	62E5	62E6	62E7	
	Char.	穆	穌	穆	窺	篙	簍	築	篤	籟	簞	篩	簞	糕	糖	縊	

Table B-4 Big5 à IBM Conversion Table (continued)

Big5		+ 0	+ 1	+ 2	+ 3	+ 4	+ 5	+ 6	+ 7	+ 8	+ 9	+ A	+ B	+ C	+ D	+ E	+ F
BFA0	IBM		62E8	62E9	62EA	62EB	62EC	62ED	62EE	62EF	62F0	62F1	62F2	62F3	62F4	62F5	62F6
	Char.		縑	縈	縛	縣	縞	縝	縉	縵	縹	縹	翰	翹	翹	擣	膳
BFB0	IBM	62F7	62F8	62F9	62FA	62FB	62FC	62FD	6341	6342	6343	6344	6345	6346	6347	6348	6349
	Char.	膩	膨	臻	興	艘	艙	蕊	蕙	蕈	蕨	蕩	蕃	蕉	蕭	蕪	蕞
BFC0	IBM	634A	634B	634C	634D	634E	634F	6350	6351	6352	6353	6354	6355	6356	6357	6358	6359
	Char.	螃	螟	螞	螢	融	衡	褪	褲	襪	襪	裕	親	覲	諦	諺	諫
BFD0	IBM	635A	635B	635C	635D	635E	635F	6360	6361	6362	6363	6364	6365	6366	6367	6368	6369
	Char.	諱	謀	諜	諧	諮	諾	謁	謂	諷	諭	詰	謔	諷	豫	猓	貓
BFE0	IBM	636A	636B	636C	636D	636E	636F	6370	6371	6372	6373	6374	6375	6376	6377	6378	6379
	Char.	賴	蹄	躑	躑	蹂	踴	輻	輯	輸	輳	辨	辦	遵	遴	選	
BFF0	IBM	637A	637B	637C	637D	637E	637F	6381	6382	6383	6384	6385	6386	6387	6388	6389	
	Char.	遲	遼	遺	鄴	醒	錠	錶	鋸	鋳	錯	錢	鋼	錫	錄	錚	
C040	IBM	638A	638B	638C	638D	638E	638F	6390	6391	6392	6393	6394	6395	6396	6397	6398	6399
	Char.	錐	錦	錡	錕	錮	錙	閻	隧	隨	險	雕	霎	霑	霖	霍	霓
C050	IBM	639A	639B	639C	639D	639E	639F	63A0	63A1	63A2	63A3	63A4	63A5	63A6	63A7	63A8	63A9
	Char.	霏	靛	靜	靦	鞞	頰	頸	頰	頰	頰	頰	頰	餐	館	餞	餽
C060	IBM	63AA	63AB	63AC	63AD	63AE	63AF	63B0	63B1	63B2	63B3	63B4	63B5	63B6	63B7	63B8	63B9
	Char.	餡	餡	駭	駢	駱	骸	骼	髻	髭	鬨	飽	鮑	鴿	鴿	鴨	鴿
C070	IBM	63BA	63BB	63BC	63BD	63BE	63BF	63C0	63C1	63C2	63C3	63C4	63C5	63C6	63C7	63C8	
	Char.	鴛	默	黔	龍	龜	優	償	儂	儲	勵	嚙	嚙	嚙	嚙	嚇	
COA0	IBM		63C9	63CA	63CB	63CC	63CD	63CE	63CF	63D0	63D1	63D2	63D3	63D4	63D5	63D6	63D7
	Char.		噓	壕	壓	壑	壙	嬰	嬪	嬪	孺	廬	屨	嶼	嶺	嶽	嶽
COB0	IBM	63D8	63D9	63DA	63DB	63DC	63DD	63DE	63DF	63E0	63E1	63E2	63E3	63E4	63E5	63E6	63E7
	Char.	幫	彌	微	應	懂	懇	懦	懣	戲	戴	擊	擊	擊	擠	擰	擦

Table B-4 Big5 à IBM Conversion Table (continued)

Big5		+ 0	+ 1	+ 2	+ 3	+ 4	+ 5	+ 6	+ 7	+ 8	+ 9	+ A	+ B	+ C	+ D	+ E	+ F
COC0	IBM	63E8	63E9	63EA	63EB	63EC	63ED	63EE	63EF	63F0	63F1	63F2	63F3	63F4	63F5	63F6	63F7
	Char.	擬	攔	擢	獲	斂	斃	曙	曖	檀	檔	檄	檢	檜	櫛	檣	櫟
COD0	IBM	63F8	63F9	63FA	63FB	63FC	63FD	6441	6442	6443	6444	6445	6446	6447	6448	6449	644A
	Char.	槩	檐	檠	歌	殮	龜	氈	濘	濱	濟	濠	濛	濤	濫	濯	澀
COE0	IBM	644B	644C	644D	644E	644F	6450	6451	6452	6453	6454	6455	6456	6457	6458	6459	645A
	Char.	濬	濡	濩	濕	濮	滌	熨	營	燮	燦	燥	燭	燬	燴	燠	爵
COF0	IBM	645B	645C	645D	645E	645F	6460	6461	6462	6463	6464	6465	6466	6467	6468	6469	
	Char.	牆	瘳	獲	璩	環	璦	璩	癆	療	瘧	盪	瞳	瞪	瞰	瞬	
C140	IBM	646A	646B	646C	646D	646E	646F	6470	6471	6472	6473	6474	6475	6476	6477	6478	6479
	Char.	瞧	瞭	矯	磷	礪	磴	礪	礁	禧	禪	穗	隆	簇	簍	篾	籐
C150	IBM	647A	647B	647C	647D	647E	647F	6481	6482	6483	6484	6485	6486	6487	6488	6489	648A
	Char.	籜	篠	糠	糜	糞	糶	糟	糙	糝	縮	績	繆	縷	縲	縲	縫
C160	IBM	648B	648C	648D	648E	648F	6490	6491	6492	6493	6494	6495	6496	6497	6498	6499	649A
	Char.	總	縱	纒	繁	絳	縹	緇	縵	縵	縵	罄	翳	翼	聳	聲	聰
C170	IBM	649B	649C	649D	649E	649F	64A0	64A1	64A2	64A3	64A4	64A5	64A6	64A7	64A8	64A9	
	Char.	聯	聳	臆	臍	膺	臂	臂	膿	膽	臉	膾	臨	舉	艱	薪	
C1A0	IBM		64AA	64AB	64AC	64AD	64AE	64AF	64B0	64B1	64B2	64B3	64B4	64B5	64B6	64B7	64B8
	Char.		薄	薈	薜	薑	薈	薯	薜	薇	蕘	薊	虧	蟀	蟀	蝻	蟒
C1B0	IBM	64B9	64BA	64BB	64BC	64BD	64BE	64BF	64C0	64C1	64C2	64C3	64C4	64C5	64C6	64C7	64C8
	Char.	蝮	蝮	蝮	螺	蝮	蝮	褻	褶	囊	褻	褻	覬	謎	謗	謙	講
C1C0	IBM	64C9	64CA	64CB	64CC	64CD	64CE	64CF	64D0	64D1	64D2	64D3	64D4	64D5	64D6	64D7	64D8
	Char.	謊	謠	謝	膳	謚	豁	豁	幽	賺	賽	購	賸	賸	趨	蹉	踢
C1D0	IBM	64D9	64DA	64DB	64DC	64DD	64DE	64DF	64E0	64E1	64E2	64E3	64E4	64E5	64E6	64E7	64E8
	Char.	蹈	蹊	轄	輶	輶	輶	輶	輶	避	遽	邁	邁	邀	鄴	醜	醜

Table B-4 Big5 à IBM Conversion Table (continued)

Big5		+ 0	+ 1	+ 2	+ 3	+ 4	+ 5	+ 6	+ 7	+ 8	+ 9	+ A	+ B	+ C	+ D	+ E	+ F
C1E0	IBM	64E9	64EA	64EB	64EC	64ED	64EE	64EF	64F0	64F1	64F2	64F3	64F4	64F5	64F6	64F7	64F8
	Char.	醜	鍍	鎂	鎢	鍵	鍊	鍍	銅	錘	鍾	鍬	鍛	鍍	錫	鍍	闊
C1F0	IBM	64F9	64FA	64FB	64FC	64FD	6541	6542	6543	6544	6545	6546	6547	6548	6549	654A	
	Char.	闕	闕	闕	闕	隱	隸	雖	霜	霞	鞠	韓	穎	颯	餵	聘	
C240	IBM	654B	654C	654D	654E	654F	6550	6551	6552	6553	6554	6555	6556	6557	6558	6559	655A
	Char.	駿	鮮	鮫	鮪	鮭	鴻	鴿	麩	黏	點	黜	黝	黨	鼯	齋	叢
C250	IBM	655B	655C	655D	655E	655F	6560	6561	6562	6563	6564	6565	6566	6567	6568	6569	656A
	Char.	嚕	嚮	墻	壘	墻	彛	懣	戳	擴	擲	擾	攆	擺	撒	擷	斷
C260	IBM	656B	656C	656D	656E	656F	6570	6571	6572	6573	6574	6575	6576	6577	6578	6579	657A
	Char.	曜	朦	檳	椽	櫃	檻	榨	權	橋	樓	欺	歸	殞	瀉	灌	濾
C270	IBM	657B	657C	657D	657E	657F	6581	6582	6583	6584	6585	6586	6587	6588	6589	658A	
	Char.	瀆	濺	瀑	瀏	燻	燼	燾	燻	獠	獵	壁	璿	甕	癬	癩	
C2A0	IBM		658B	658C	658D	658E	658F	6590	6591	6592	6593	6594	6595	6596	6597	6598	6599
	Char.		癒	瞽	瞿	瞻	瞼	礎	禮	穉	穢	穢	竄	竅	簫	簧	簪
C2B0	IBM	659A	659B	659C	659D	659E	659F	65A0	65A1	65A2	65A3	65A4	65A5	65A6	65A7	65A8	65A9
	Char.	箠	篲	簡	糴	織	繕	繞	繚	繡	繪	繙	罈	翹	翻	職	聶
C2C0	IBM	65AA	65AB	65AC	65AD	65AE	65AF	65B0	65B1	65B2	65B3	65B4	65B5	65B6	65B7	65B8	65B9
	Char.	臍	臍	舊	藏	薩	藍	藐	藉	薰	薺	臺	薦	蟻	蟬	蟲	蟠
C2D0	IBM	65BA	65BB	65BC	65BD	65BE	65BF	65C0	65C1	65C2	65C3	65C4	65C5	65C6	65C7	65C8	65C9
	Char.	覆	覲	鳩	謨	謹	謬	謫	豐	贅	蹙	蹙	蹙	蹤	蹟	蹕	軀
C2E0	IBM	65CA	65CB	65CC	65CD	65CE	65CF	65D0	65D1	65D2	65D3	65D4	65D5	65D6	65D7	65D8	65D9
	Char.	轉	轍	邈	邃	邈	醫	醬	釐	鎔	鎔	鎖	鎬	鎬	鎬	鎬	鎬
C2F0	IBM	65DA	65DB	65DC	65DD	65DE	65DF	65E0	65E1	65E2	65E3	65E4	65E5	65E6	65E7	65E8	
	Char.	鎬	鎬	鎬	闕	闕	闕	闕	離	雜	雙	雜	雞	雷	鞣	鞣	

Table B-4 Big5 à IBM Conversion Table (continued)

Big5		+ 0	+ 1	+ 2	+ 3	+ 4	+ 5	+ 6	+ 7	+ 8	+ 9	+ A	+ B	+ C	+ D	+ E	+ F
C340	IBM	65E9	65EA	65EB	65EC	65ED	65EE	65EF	65F0	65F1	65F2	65F3	65F4	65F5	65F6	65F7	65F8
	Char.	鞭	靛	額	顏	題	顎	頰	颯	餹	餽	饒	饗	馥	騎	髀	鬚
C350	IBM	65F9	65FA	65FB	65FC	65FD	6641	6642	6643	6644	6645	6646	6647	6648	6649	664A	664B
	Char.	鬆	魏	頰	鯉	鯉	鯉	鯉	鯉	鯉	鯉	鯉	鯉	鯉	鯉	鯉	鯉
C360	IBM	664C	664D	664E	664F	6650	6651	6652	6653	6654	6655	6656	6657	6658	6659	665A	665B
	Char.	嚙	壞	雙	堰	寵	龐	廬	愆	懷	懶	惜	攀	攏	曠	曝	樹
C370	IBM	665C	665D	665E	665F	6660	6661	6662	6663	6664	6665	6666	6667	6668	6669	666A	
	Char.	檣	欄	櫓	瀛	瀟	瀨	瀚	瀝	瀕	瀟	爆	爍	贖	憤	獸	
C3A0	IBM		666B	666C	666D	666E	666F	6670	6671	6672	6673	6674	6675	6676	6677	6678	6679
	Char.		獺	璽	瓊	辦	疇	疆	癩	癡	矇	礙	禱	穫	穩	簾	簿
C3B0	IBM	667A	667B	667C	667D	667E	667F	6681	6682	6683	6684	6685	6686	6687	6688	6689	668A
	Char.	簸	簽	簷	箝	繫	繭	繹	繩	繪	羅	繳	羶	羹	羸	臘	藩
C3C0	IBM	668B	668C	668D	668E	668F	6690	6691	6692	6693	6694	6695	6696	6697	6698	6699	669A
	Char.	藝	藪	藕	藤	藥	藟	蟻	蠅	蠟	蟹	蟾	襠	襟	襖	襪	諱
C3D0	IBM	669B	669C	669D	669E	669F	66A0	66A1	66A2	66A3	66A4	66A5	66A6	66A7	66A8	66A9	66AA
	Char.	譜	識	證	譚	譎	譏	諱	譙	贈	贊	蹠	蹲	蹣	蹠	蹠	蹠
C3E0	IBM	66AB	66AC	66AD	66AE	66AF	66B0	66B1	66B2	66B3	66B4	66B5	66B6	66B7	66B8	66B9	66BA
	Char.	蹴	麟	轎	辭	邊	邈	醜	醜	鏡	鎚	鎚	鎚	鎚	鎚	鎚	鎚
C3F0	IBM	66BB	66BC	66BD	66BE	66BF	66C0	66C1	66C2	66C3	66C4	66C5	66C6	66C7	66C8	66C9	
	Char.	鏢	鏢	鏢	鏢	鏢	鏢	鏢	鏢	鏢	鏢	鏢	鏢	鏢	鏢	鏢	
C440	IBM	66CA	66CB	66CC	66CD	66CE	66CF	66D0	66D1	66D2	66D3	66D4	66D5	66D6	66D7	66D8	66D9
	Char.	願	顛	颯	餽	饗	驚	騙	鬚	鯨	鯨	鯨	鯨	鯨	鯨	鯨	鯨
C450	IBM	66DA	66DB	66DC	66DD	66DE	66DF	66E0	66E1	66E2	66E3	66E4	66E5	66E6	66E7	66E8	66E9
	Char.	鵬	麒	麗	麓	麴	勸	囑	囑	囑	囑	囑	囑	囑	囑	囑	囑

Table B-4 Big5 à IBM Conversion Table (continued)

Big5		+ 0	+ 1	+ 2	+ 3	+ 4	+ 5	+ 6	+ 7	+ 8	+ 9	+ A	+ B	+ C	+ D	+ E	+ F
C460	IBM	66EA	66EB	66EC	66ED	66EE	66EF	66F0	66F1	66F2	66F3	66F4	66F5	66F6	66F7	66F8	66F9
	Char.	嶼	懸	懺	攘	攔	揀	曦	朧	椶	瀾	瀾	激	爐	獻	壠	瘵
C470	IBM	66FA	66FB	66FC	66FD	6741	6742	6743	6744	6745	6746	6747	6748	6749	674A	674B	
	Char.	痲	礦	礪	礬	礪	寶	競	籌	籃	籍	糯	糲	辦	續	繼	
C4A0	IBM		674C	674D	674E	674F	6750	6751	6752	6753	6754	6755	6756	6757	6758	6759	675A
	Char.		纂	嬰	耀	臚	艦	藻	藹	藟	藟	蘆	蕓	蘇	蘊	蠟	蠕
C4B0	IBM	675B	675C	675D	675E	675F	6760	6761	6762	6763	6764	6765	6766	6767	6768	6769	676A
	Char.	檻	覺	觸	議	警	警	譯	諜	諜	贏	贍	蕙	躁	躑	躑	醴
C4C0	IBM	676B	676C	676D	676E	676F	6770	6771	6772	6773	6774	6775	6776	6777	6778	6779	677A
	Char.	釋	鐘	鏡	鏞	闡	霰	飄	鏡	饑	馨	騫	騰	騷	駟	鰓	鰓
C4D0	IBM	677B	677C	677D	677E	677F	6781	6782	6783	6784	6785	6786	6787	6788	6789	678A	678B
	Char.	鹹	麵	黨	麗	齟	齟	齡	儷	穉	囁	囁	冢	菱	屬	巍	懼
C4E0	IBM	678C	678D	678E	678F	6790	6791	6792	6793	6794	6795	6796	6797	6798	6799	679A	679B
	Char.	懾	攝	攜	爛	羸	櫻	欄	櫺	穢	灌	爛	犧	環	瓔	癩	隴
C4F0	IBM	679C	679D	679E	679F	67A0	67A1	67A2	67A3	67A4	67A5	67A6	67A7	67A8	67A9	67AA	
	Char.	籐	纏	續	屨	藁	藟	藟	蠟	蠢	蠱	蠟	襪	襪	覽	謹	
C540	IBM	67AB	67AC	67AD	67AE	67AF	67B0	67B1	67B2	67B3	67B4	67B5	67B6	67B7	67B8	67B9	67BA
	Char.	護	譽	賊	躑	躑	躑	躑	辯	醜	鑣	鑣	鐵	鎗	鐸	鐸	鎗
C550	IBM	67BB	67BC	67BD	67BE	67BF	67C0	67C1	67C2	67C3	67C4	67C5	67C6	67C7	67C8	67C9	67CA
	Char.	關	霸	霹	露	響	顛	顛	饗	驅	驃	驃	騾	騾	魔	魑	魑
C560	IBM	67CB	67CC	67CD	67CE	67CF	67D0	67D1	67D2	67D3	67D4	67D5	67D6	67D7	67D8	67D9	67DA
	Char.	鰓	鶯	鶴	鶴	鶯	鶯	鶯	鶯	魷	齧	齧	儼	儼	嚙	囊	囉
C570	IBM	67DB	67DC	67DD	67DE	67DF	67E0	67E1	67E2	67E3	67E4	67E5	67E6	67E7	67E8	67E9	
	Char.	孿	巔	巔	巔	巔	攤	權	歡	灑	灑	灑	瓢	疊	癩	癩	

Table B-4 Big5 à IBM Conversion Table (continued)

Big5		+ 0	+ 1	+ 2	+ 3	+ 4	+ 5	+ 6	+ 7	+ 8	+ 9	+ A	+ B	+ C	+ D	+ E	+ F
C5A0	IBM		67EA	67EB	67EC	67ED	67EE	67EF	67F0	67F1	67F2	67F3	67F4	67F5	67F6	67F7	67F8
	Char.		禳	籠	籟	聾	聽	臙	襲	襪	簾	讀	贖	覺	躑	躑	響
C5B0	IBM	67F9	67FA	67FB	67FC	67FD	6841	6842	6843	6844	6845	6846	6847	6848	6849	684A	684B
	Char.	鄺	鑄	鑑	鑿	霽	霏	韃	韃	顛	饗	驕	驍	髒	鬚	繁	鏈
C5C0	IBM	684C	684D	684E	684F	6850	6851	6852	6853	6854	6855	6856	6857	6858	6859	685A	685B
	Char.	鏢	鰻	鷓	鷗	麗	語	齷	龔	龔	巖	戀	攀	攪	攪	曬	擺
C5D0	IBM	685C	685D	685E	685F	6860	6861	6862	6863	6864	6865	6866	6867	6868	6869	686A	686B
	Char.	瓚	竊	籤	簡	箭	纓	織	纒	贖	蕪	蘿	蠱	變	邏	邏	鑣
C5E0	IBM	686C	686D	686E	686F	6870	6871	6872	6873	6874	6875	6876	6877	6878	6879	687A	687B
	Char.	鑠	鏢	壓	顯	壓	驚	驛	驗	髓	體	觸	鱧	鱗	鱖	鷲	麟
C5F0	IBM	687C	687D	687E	687F	6881	6882	6883	6884	6885	6886	6887	6888	6889	688A	688B	
	Char.	徽	囑	壩	攬	灑	癱	癩	轟	罐	羈	蠶	蠹	衢	讓	讓	
C640	IBM	688C	688D	688E	688F	6890	6891	6892	6893	6894	6895	6896	6897	6898	6899	689A	689B
	Char.	識	艷	籟	釀	鑪	靈	靈	靄	韃	犖	驟	鬢	覓	鬣	鷹	鷲
C650	IBM	689C	689D	689E	689F	68A0	68A1	68A2	68A3	68A4	68A5	68A6	68A7	68A8	68A9	68AA	68AB
	Char.	嶮	鹽	龍	齷	齷	廳	攬	灣	籬	籬	蠻	觀	躡	覺	鑲	鎗
C660	IBM	68AC	68AD	68AE	68AF	68B0	68B1	68B2	68B3	68B4	68B5	68B6	68B7	68B8	68B9	68BA	68BB
	Char.	顛	饒	腕	蠶	鬢	淥	矚	讚	鑄	韃	驢	驥	纜	謙	躡	醜
C670	IBM	68BC	68BD	68BE	68BF	68C0	68C1	68C2	68C3	68C4	68C5	68C6	68C7	68C8	68C9	68CA	
	Char.	鑽	鑿	鑼	鍾	鑪	贖	豔	鑿	鸚	襲	驢	鬱	鶴	鸞	籟	
C6A0	IBM		FFFF	FFFF	FFFF	FFFF	FFFF	FFFF	FFFF	FFFF	FFFF	FFFF	FFFF	FFFF	FFFF	FFFF	FFFF
	Char.																

Table B-4 Big5 à IBM Conversion Table (continued)

Big5		+ 0	+ 1	+ 2	+ 3	+ 4	+ 5	+ 6	+ 7	+ 8	+ 9	+ A	+ B	+ C	+ D	+ E	+ F
C6B0	IBM	FFFF	FFFF	FFFF	FFFF	FFFF	FFFF	FFFF	FFFF	FFFF	FFFF	FFFF	FFFF	FFFF	FFFF	FFFF	FFFF
	Char.																
C6C0	IBM	FFFF	FFFF	FFFF	FFFF	FFFF	FFFF	FFFF	FFFF	FFFF	FFFF	FFFF	FFFF	FFFF	FFFF	FFFF	FFFF
	Char.																
C6D0	IBM	FFFF	FFFF	FFFF	FFFF	FFFF	FFFF	FFFF	FFFF	FFFF	FFFF	FFFF	FFFF	FFFF	FFFF	FFFF	FFFF
	Char.																
C6E0	IBM	FFFF	FFFF	FFFF	FFFF	FFFF	FFFF	FFFF	FFFF	FFFF	FFFF	FFFF	FFFF	FFFF	FFFF	FFFF	FFFF
	Char.																
C6F0	IBM	FFFF	FFFF	FFFF	FFFF	FFFF	FFFF	FFFF	FFFF	FFFF	FFFF	FFFF	FFFF	FFFF	FFFF	FFFF	FFFF
	Char.																
C740	IBM	FFFF	FFFF	FFFF	FFFF	FFFF	FFFF	FFFF	FFFF	FFFF	FFFF	FFFF	FFFF	FFFF	FFFF	FFFF	FFFF
	Char.																
C750	IBM	FFFF	FFFF	FFFF	FFFF	FFFF	FFFF	FFFF	FFFF	FFFF	FFFF	FFFF	FFFF	FFFF	FFFF	FFFF	FFFF
	Char.																
C760	IBM	FFFF	FFFF	FFFF	FFFF	FFFF	FFFF	FFFF	FFFF	FFFF	FFFF	FFFF	FFFF	FFFF	FFFF	FFFF	FFFF
	Char.																
C770	IBM	FFFF	FFFF	FFFF	FFFF	FFFF	FFFF	FFFF	FFFF	FFFF	FFFF	FFFF	FFFF	FFFF	FFFF	FFFF	FFFF
	Char.																
C7A0	IBM		FFFF	FFFF	FFFF	FFFF	FFFF	FFFF	FFFF	FFFF	FFFF	FFFF	FFFF	FFFF	FFFF	FFFF	FFFF
	Char.																
C7B0	IBM	FFFF	FFFF	FFFF	FFFF	FFFF	FFFF	FFFF	FFFF	FFFF	FFFF	FFFF	FFFF	FFFF	FFFF	FFFF	FFFF
	Char.																

Table B-4 Big5 à IBM Conversion Table (continued)

Big5		+ 0	+ 1	+ 2	+ 3	+ 4	+ 5	+ 6	+ 7	+ 8	+ 9	+ A	+ B	+ C	+ D	+ E	+ F
C7C0	IBM	FFFF	FFFF	FFFF	FFFF	FFFF	FFFF	FFFF	FFFF	FFFF	FFFF	FFFF	FFFF	FFFF	FFFF	FFFF	FFFF
	Char.																
C7D0	IBM	FFFF	FFFF	FFFF	FFFF	FFFF	FFFF	FFFF	FFFF	FFFF	FFFF	FFFF	FFFF	FFFF	FFFF	FFFF	FFFF
	Char.																
C7E0	IBM	FFFF	FFFF	FFFF	FFFF	FFFF	FFFF	FFFF	FFFF	FFFF	FFFF	FFFF	FFFF	FFFF	FFFF	FFFF	FFFF
	Char.																
C7F0	IBM	FFFF	FFFF	FFFF	FFFF	FFFF	FFFF	FFFF	FFFF	FFFF	FFFF	FFFF	FFFF	FFFF	FFFF	FFFF	FFFF
	Char.																
C840	IBM	FFFF	FFFF	FFFF	FFFF	FFFF	FFFF	FFFF	FFFF	FFFF	FFFF	FFFF	FFFF	FFFF	FFFF	FFFF	FFFF
	Char.																
C850	IBM	FFFF	FFFF	FFFF	FFFF	FFFF	FFFF	FFFF	FFFF	FFFF	FFFF	FFFF	FFFF	FFFF	FFFF	FFFF	FFFF
	Char.																
C860	IBM	FFFF	FFFF	FFFF	FFFF	FFFF	FFFF	FFFF	FFFF	FFFF	FFFF	FFFF	FFFF	FFFF	FFFF	FFFF	FFFF
	Char.																
C870	IBM	FFFF	FFFF	FFFF	FFFF	FFFF	FFFF	FFFF	FFFF	FFFF	FFFF	FFFF	FFFF	FFFF	FFFF	FFFF	FFFF
	Char.																
C8A0	IBM		FFFF	FFFF	FFFF	FFFF	FFFF	FFFF	FFFF	FFFF	FFFF	FFFF	FFFF	FFFF	FFFF	FFFF	FFFF
	Char.																
C8B0	IBM	FFFF	FFFF	FFFF	FFFF	FFFF	FFFF	FFFF	FFFF	FFFF	FFFF	FFFF	FFFF	FFFF	FFFF	FFFF	FFFF
	Char.																
C8C0	IBM	FFFF	FFFF	FFFF	FFFF	FFFF	FFFF	FFFF	FFFF	FFFF	FFFF	FFFF	FFFF	FFFF	FFFF	FFFF	FFFF
	Char.																
C8D0	IBM	FFFF	FFFF	FFFF	FFFF	FFFF	FFFF	FFFF	FFFF	FFFF	FFFF	FFFF	FFFF	FFFF	FFFF	FFFF	FFFF
	Char.																

Table B-4 Big5 à IBM Conversion Table (continued)

Big5		+ 0	+ 1	+ 2	+ 3	+ 4	+ 5	+ 6	+ 7	+ 8	+ 9	+ A	+ B	+ C	+ D	+ E	+ F
C8E0	IBM	FFFF	FFFF	FFFF	FFFF	FFFF	FFFF	FFFF	FFFF	FFFF	FFFF	FFFF	FFFF	FFFF	FFFF	FFFF	FFFF
	Char.																
C8F0	IBM	FFFF	FFFF	FFFF	FFFF	FFFF	FFFF	FFFF	FFFF	FFFF	FFFF	FFFF	FFFF	FFFF	FFFF	FFFF	
	Char.																
C940	IBM	6941	6942	6943	6944	6945	6946	6947	6948	6949	694A	694B	694C	694D	694E	694F	6950
	Char.	义	乜	凵	匚	厂	万	丌	毛	丌	口	兀	艸	彳	丐	有	与
C950	IBM	6951	6952	6953	6954	6955	6956	6957	6958	6959	695A	695B	695C	695D	695E	695F	6960
	Char.	乚	丌	仂	仇	伙	尢	旬	叩	虫	乚	廾	夫	夂	市	无	爰
C960	IBM	6961	6962	6963	6964	6965	6966	6967	6968	6969	696A	696B	696C	696D	696E	696F	6970
	Char.	毋	气	冫	艸	井	仁	仁	仕	乞	全	亼	刑	匚	冊	疋	圣
C970	IBM	6971	6972	6973	6974	6975	6976	6977	6978	6979	697A	697B	697C	697D	697E	697F	
	Char.	夂	秀	宁	宀	余	尻	艸	亼	疋	疋	庆	切	戎	劫	气	
C9A0	IBM		6981	6982	6983	6984	6985	6986	6987	6988	6989	698A	698B	698C	698D	698E	698F
	Char.		承	汨	洸	边	友	犭	王	肉	肱	助	伎	优	伋	件	伋
C9B0	IBM	6990	6991	6992	6993	6994	6995	6996	6997	6998	6999	699A	699B	699C	699D	699E	699F
	Char.	伶	佢	价	佢	佢	佢	佢	佢	佢	佢	佢	佢	佢	佢	佢	佢
C9C0	IBM	69A0	69A1	69A2	69A3	69A4	69A5	69A6	69A7	69A8	69A9	69AA	69AB	69AC	69AD	69AE	69AF
	Char.	荔	匚	匚	卂	屮	呼	囟	囟	圪	圪	均	尢	改	姪	虹	姪
C9D0	IBM	69B0	69B1	69B2	69B3	69B4	69B5	69B6	69B7	69B8	69B9	69BA	69BB	69BC	69BD	69BE	69BF
	Char.	妲	奸	尢	孛	尢	尢	岷	岷	岷	岷	荒	开	庄	异	第	狗
C9E0	IBM	69C0	69C1	69C2	69C4	69C5	69C6	69C7	69C8	69C9	69CA	69CB	69CC	69C3	69CD	69CE	69CF
	Char.	伙	乞	忡	扌	扌	扌	扌	扌	扌	扌	扌	扌	扌	扌	扌	扌
C9F0	IBM	69D0	69D1	69D2	69D3	69D4	69D5	69D6	69D7	69D8	69D9	69DA	69DB	69DC	69DD	69DE	
	Char.	机	机	机	机	束	机	机	机	机	机	机	机	机	机	机	

Table B-4 Big5 à IBM Conversion Table (continued)

Big5		+ 0	+ 1	+ 2	+ 3	+ 4	+ 5	+ 6	+ 7	+ 8	+ 9	+ A	+ B	+ C	+ D	+ E	+ F
CA40	IBM	69DF	69E0	69E1	69E2	69E3	69E4	69E5	69E6	69E7	69E8	69E9	69EA	69EB	69EC	69ED	69EE
	Char.	洄	刼	勃	犴	犵	玎	甬	亂	竈	网	艸	芋	芳	芄	茆	虎
CA50	IBM	69EF	69F0	69F1	69F2	69F3	69F4	69F5	69F6	69F7	69F8	69F9	69FA	69FB	69FC	69FD	6A41
	Char.	兩	邨	邨	邨	邨	邨	阨	阨	阨	阨	阨	倅	倅	倅	倅	倅
CA60	IBM	6A42	6A43	6A44	6A45	6A46	6A47	6A48	6A49	6A4A	6A4B	6A4C	6A4D	6A4E	6A4F	6A50	6A51
	Char.	伧	倅	倅	倅	倅	余	佗	世	倅	倅	倅	倅	倅	倅	倅	倅
CA70	IBM	6A52	6A53	6A54	6A55	6A56	6A57	6A58	6A59	6A5A	6A5B	6A5C	6A5D	6A5E	6A5F	6A60	
	Char.	刼	刼	刼	刼	底	厓	呬	呬	呬	呬	呬	呬	呬	呬	呬	
CAA0	IBM		6A61	6A62	6A63	6A64	6A65	6A66	6A67	6A68	6A69	6A6A	6A6B	6A6C	6A6D	6A6E	6A6F
	Char.		咩	咩	咩	咩	咩	咩	咩	咩	咩	咩	咩	咩	咩	咩	咩
CAB0	IBM	6A70	6A71	6A72	6A73	6A74	6A75	6A76	6A77	6A78	6A79	6A7A	6A7B	6A7C	6A7D	6A7E	6A7F
	Char.	峯	柔	姪	姪	姪	姪	姪	姪	姪	姪	姪	姪	姪	姪	姪	姪
CAC0	IBM	6A81	6A82	6A83	6A84	6A85	6A86	6A87	6A88	6A89	6A8A	6A8B	6A8C	6A8D	6A8E	6A8F	6A90
	Char.	岍	岍	岍	岍	岍	岍	岍	岍	岍	岍	岍	岍	岍	岍	岍	岍
CAD0	IBM	6A91	6A92	6A93	6A94	6A95	6A96	6A97	6A98	6A99	6A9A	6A9B	6A9C	6A9D	6A9E	6A9F	6AA0
	Char.	岍	岍	岍	岍	岍	岍	岍	岍	岍	岍	岍	岍	岍	岍	岍	岍
CAE0	IBM	6AA1	6AA2	6AA3	6AA4	6AA5	6AA6	6AA7	6AA8	6AA9	6AAA	6AAB	6AAC	6AAD	6AAE	6AAF	6AB0
	Char.	岍	岍	岍	岍	岍	岍	岍	岍	岍	岍	岍	岍	岍	岍	岍	岍
CAF0	IBM	6AB1	6AB2	6AB3	6AB4	6AB5	6AB6	6AB7	6AB8	6AB9	6ABA	6ABB	6ABC	6ABD	6ABE	6ABF	
	Char.	抚	抚	抚	抚	抚	抚	抚	抚	抚	抚	抚	抚	抚	抚	抚	
CB40	IBM	6AC0	6AC1	6AC2	6AC3	6AC4	6AC5	6AC6	6AC7	6AC8	6AC9	6ACA	6ACB	6ACC	6ACD	6ACE	6ACF
	Char.	杙	杙	杙	杙	杙	杙	杙	杙	杙	杙	杙	杙	杙	杙	杙	杙
CB50	IBM	6AD0	6AD1	6AD2	6AD3	6AD4	6AD5	6AD6	6AD7	6AD8	6AD9	6ADA	6ADB	6ADC	6ADD	6ADE	6ADF
	Char.	沕	沕	沕	沕	沕	沕	沕	沕	沕	沕	沕	沕	沕	沕	沕	沕

Table B-4 Big5 à IBM Conversion Table (continued)

Big5		+ 0	+ 1	+ 2	+ 3	+ 4	+ 5	+ 6	+ 7	+ 8	+ 9	+ A	+ B	+ C	+ D	+ E	+ F
CB60	IBM	6AE0	6AE1	6AE2	6AE3	6AE4	6AE5	6AE6	6AE7	6AE8	6AE9	6AEA	6AEB	6AEC	6AED	6AEE	6AEF
	Char.	物	狝	狎	狎	狎	狎	狎	狎	狎	狎	玁	玁	玁	玁	玁	疔
CB70	IBM	6AF0	6AF1	6AF2	6AF3	6AF4	6AF5	6AF6	6AF7	6AF8	6AF9	6AFA	6AFB	6AFC	6AFD	6B41	
	Char.	疔	阜	衲	聒	舛	肩	肱	肱	彤	苻	苻	芑	芑	芑	芑	
CBA0	IBM		6B42	6B43	6B44	6B45	6B46	6B47	6B48	6B49	6B4A	6B4B	6B4C	6B4D	6B4E	6B4F	6B50
	Char.		苻	苻	豸	迨	迨	邗	邗	邗	邗	邗	邗	邗	阝	阝	阝
CBBO	IBM	6B51	6B52	6B53	6B54	6B55	6B56	6B57	6B58	6B59	6B5A	6B5B	6B5C	6B5D	6B5E	6B5F	6B60
	Char.	阝	弗	侏	侏	侏	侏	侏	侏	侏	侏	侏	侏	侏	侏	侏	侏
CBC0	IBM	6B61	6B62	6B63	6B64	6B65	6B66	6B67	6B68	6B69	6B6A	6B6B	6B6C	6B6D	6B6E	6B6F	6B70
	Char.	侏	侏	侏	侏	侏	侏	侏	侏	侏	侏	侏	侏	侏	侏	侏	侏
CBD0	IBM	6B71	6B72	6B73	6B74	6B75	6B76	6B77	6B78	6B79	6B7A	6B7B	6B7C	6B7D	6B7E	6B7F	6B81
	Char.	刂	刂	刂	刂	刂	刂	刂	刂	匚	匚	匚	叻	叻	叻	叻	叻
CBE0	IBM	6B82	6B83	6B84	6B85	6B86	6B87	6B88	6B89	6B8A	6B8B	6B8C	6B8D	6B8E	6B8F	6B90	6B91
	Char.	叻	叻	叻	叻	叻	叻	叻	叻	哈	呼	眠	唵	唵	唵	唵	唵
CBF0	IBM	6B92	6B93	6B94	6B95	6B96	6B97	6B98	6B99	6B9A	6B9B	6B9C	6B9D	6B9E	6B9F	6BA0	
	Char.	圉	圉	坏	拂	坭	坭	坭	坭	坭	坪	坭	坭	坭	坭	坭	坭
CC40	IBM	6BA1	6BA2	6BA3	6BA4	6BA5	6BA6	6BA7	6BA8	6BA9	6BAA	6BAB	6BAC	6BAD	6BAE	6BAF	6BB0
	Char.	坭	玲	菱	菱	姪	姪	姪	姪	姪	姪	姪	姪	姪	姪	姪	姪
CC50	IBM	6BB1	6BB2	6BB3	6BB4	6BB5	6BB6	6BB7	6BB8	6BB9	6BBA	6BBB	6BBC	6BBD	6BBE	6BBF	6BC0
	Char.	姪	姪	姪	姪	姪	姪	姪	姪	岩	辰	屈	屹	屹	屹	屹	屹
CC60	IBM	6BC1	6BC2	6BC3	6BC4	6BC5	6BC6	6BC7	6BC8	6BC9	6BCA	6BCB	6BCC	6BCD	6BCE	6BCF	6BD0
	Char.	岨	岨	岨	岨	岨	岨	岨	岨	岨	岨	岨	岨	岨	岨	岨	岨
CC70	IBM	6BD1	6BD2	6BD3	6BD4	6BD5	6BD6	6BD7	6BD8	6BD9	6BDA	6BDB	6BDC	6BDD	6BDE	6BDF	
	Char.	弨	弨	弨	弨	弨	徂	徂	徂	恣	恣	恣	恣	恣	恣	恣	恣

Table B-4 Big5 à IBM Conversion Table (continued)

Big5		+ 0	+ 1	+ 2	+ 3	+ 4	+ 5	+ 6	+ 7	+ 8	+ 9	+ A	+ B	+ C	+ D	+ E	+ F
CCA0	IBM		6BE0	6BE1	6BE2	6BE3	6BE4	6BE5	6BE6	6BE7	6BE8	6BE9	6BEA	6BEB	6BEC	6BED	6BEE
	Char.		悫	悫	悫	悫	悫	悫	悫	悫	悫	悫	悫	悫	悫	悫	悫
CCB0	IBM	6BEF	6BF0	6BF1	6BF2	6BF3	6BF4	6BF5	6BF6	6BF7	6BF8	6BF9	6BFA	6BFB	6BFC	6BFD	6C41
	Char.	悫	悫	悫	悫	悫	悫	悫	悫	悫	悫	悫	悫	悫	悫	悫	悫
CCC0	IBM	6C42	6C43	6C44	6C45	6C46	6C47	6C48	6C49	6C4A	6C4B	6C4C	6C4D	6C4E	6C4F	6C50	6C51
	Char.	悫	悫	悫	悫	悫	悫	悫	悫	悫	悫	悫	悫	悫	悫	悫	悫
CCD0	IBM	6C52	6C53	6C54	6C55	6C56	6C57	6C58	6C59	6C5A	6C5B	6C5C	6C5D	6C5E	6C5F	6C60	6C61
	Char.	悫	悫	悫	悫	悫	悫	悫	悫	悫	悫	悫	悫	悫	悫	悫	悫
CCE0	IBM	6C62	6C63	6C64	6C65	6C66	6C67	6C68	6C69	6C6A	6C6B	6C6C	6C6D	6C6E	6C6F	6C70	6C71
	Char.	悫	悫	悫	悫	悫	悫	悫	悫	悫	悫	悫	悫	悫	悫	悫	悫
CCF0	IBM	6C72	6C73	6C74	6C75	6C76	6C77	6C78	6C79	6C7A	6C7B	6C7C	6C7D	6C7E	6C7F	6C81	
	Char.	悫	悫	悫	悫	悫	悫	悫	悫	悫	悫	悫	悫	悫	悫	悫	
CD40	IBM	6C82	6C83	6C84	6C85	6C86	6C87	6C88	6C89	6C8A	6C8B	6C8C	6C8D	6C8E	6C8F	6C90	6C91
	Char.	悫	悫	悫	悫	悫	悫	悫	悫	悫	悫	悫	悫	悫	悫	悫	悫
CD50	IBM	6C92	6C93	6C94	6C95	6C96	6C97	6C98	6C99	6C9A	6C9B	6C9C	6C9D	6C9E	6C9F	6CA0	6CA1
	Char.	悫	悫	悫	悫	悫	悫	悫	悫	悫	悫	悫	悫	悫	悫	悫	悫
CD60	IBM	6CA2	6CA3	6CA4	6CA5	6CA6	6CA7	6CA8	6CA9	6CAA	6CAB	6CAC	6CAD	6CAE	6CAF	6CB0	6CB1
	Char.	悫	悫	悫	悫	悫	悫	悫	悫	悫	悫	悫	悫	悫	悫	悫	悫
CD70	IBM	6CB2	6CB3	6CB4	6CB5	6CB6	6CB7	6CB8	6CB9	6CBA	6CBB	6CBC	6CBD	6CBE	6CBF	6CC0	
	Char.	悫	悫	悫	悫	悫	悫	悫	悫	悫	悫	悫	悫	悫	悫	悫	
CDA0	IBM		6CC1	6CC2	6CC3	6CC4	6CC5	6CC6	6CC7	6CC8	6CC9	6CCA	6CCB	6CCC	6CCD	6CCE	6CCF
	Char.		悫	悫	悫	悫	悫	悫	悫	悫	悫	悫	悫	悫	悫	悫	悫
CDB0	IBM	6CD0	6CD1	6CD2	6CD3	6CD4	6CD5	6CD6	6CD7	6CD8	6CD9	6CDA	6CDB	6CDC	6CDD	6CDE	6CDF
	Char.	悫	悫	悫	悫	悫	悫	悫	悫	悫	悫	悫	悫	悫	悫	悫	悫

Table B-4 Big5 à IBM Conversion Table (continued)

Big5		+ 0	+ 1	+ 2	+ 3	+ 4	+ 5	+ 6	+ 7	+ 8	+ 9	+ A	+ B	+ C	+ D	+ E	+ F
CDC0	IBM	6CE0	6CE1	6CE2	6CE3	6CE4	6CE5	6CE6	6CE7	6CE8	6CE9	6CEA	6CEB	6CEC	6CED	6CEE	6CEF
	Char.	茈	芩	艾	菀	茛	苈	苈	苈	虬	虬	虬	豕	迳	迳	迳	迳
CDD0	IBM	6CF0	6CF1	6CF2	6CF3	6CF4	6CF5	6CF6	6CF7	6CF8	6CF9	6CFA	6CFB	6CFC	6CFD	6D41	6D42
	Char.	达	迳	迳	邲	邲	邲	邲	邲	陆	陆	阡	阡	阡	俚	俚	徑
CDE0	IBM	6D43	6D44	6D45	6D46	6D47	6D48	6D49	6D4A	6D4B	6D4C	6D4D	6D4E	6D4F	6D50	6D51	6D52
	Char.	偃	偃	偃	俛	俛	俛	俛	俛	俛	俛	徃	徃	倭	倭	倭	俛
CDF0	IBM	6D53	6D54	6D55	6D56	6D57	6D58	6D59	6D5A	6D5B	6D5C	6D5D	6D5E	6D5F	6D60	6D61	
	Char.	剽	剽	劼	劼	匱	脍	脍	脍	脍	脍	嘔	嘔	咭	咭	喂	
CE40	IBM	6D62	6D63	6D64	6D65	6D66	6D67	6D68	6D69	6D6A	6D6B	6D6C	6D6D	6D6E	6D6F	6D70	6D71
	Char.	响	苟	咷	咷	咷	咷	咷	咷	聃	聃	聃	聃	聃	吡	咷	响
CE50	IBM	6D72	6D73	6D74	6D75	6D76	6D77	6D78	6D79	6D7A	6D7B	6D7C	6D7D	6D7E	6D7F	6D81	6D82
	Char.	垠	垠	垠	垠	垠	垠	垠	垠	壘	壘	埭	埭	埭	埭	垠	壘
CE60	IBM	6D83	6D84	6D85	6D86	6D87	6D88	6D89	6D8A	6D8B	6D8C	6D8D	6D8E	6D8F	6D90	6D91	6D92
	Char.	复	爹	媯	媯	媯	媯	媯	媯	媯	媯	媯	媯	媯	媯	媯	媯
CE70	IBM	6D93	6D94	6D95	6D96	6D97	6D98	6D99	6D9A	6D9B	6D9C	6D9D	6D9E	6D9F	6DA0	6DA1	
	Char.	姪	姪	姪	姪	姪	裂	裂	裂	屮	岷	岷	岷	岷	岷	岷	
CEA0	IBM		6DA2	6DA3	6DA4	6DA5	6DA6	6DA7	6DA8	6DA9	6DAA	6DAB	6DAC	6DAD	6DAE	6DAF	6DB0
	Char.		崙	崙	崙	崙	崙	崙	崙	崙	崙	崙	崙	崙	崙	崙	崙
CEB0	IBM	6DB1	6DB2	6DB3	6DB4	6DB5	6DB6	6DB7	6DB8	6DB9	6DBA	6DBB	6DBC	6DBD	6DBE	6DBF	6DC0
	Char.	幷	哈	帑	帑	帑	帑	帑	庠	庠	庠	庠	庠	庠	象	徯	恣
CECO	IBM	6DC1	6DC2	6DC3	6DC4	6DC5	6DC6	6DC7	6DC8	6DC9	6DC A	6DCB	6DCC	6DC D	6DCE	6DCF	6DD 0
	Char.	恣	悛	悛	悛	悛	恣	恣	恣	恣	恣	恣	恣	恣	恣	悛	悛

Table B-4 Big5 à IBM Conversion Table (continued)

Big5		+ 0	+ 1	+ 2	+ 3	+ 4	+ 5	+ 6	+ 7	+ 8	+ 9	+ A	+ B	+ C	+ D	+ E	+ F
CED0	IBM	6DD1	6DD2	6DD3	6DD4	6DD5	6DD6	6DD7	6DD8	6DD9	6DDA	6ddb	6DDC	6DDD	6DDE	6DDF	6DE0
	Char.	恂	恂	扃	扃	拏	拏	拏	拏	拏	拏	拏	拏	拏	拏	拏	拏
CEE0	IBM	6DE1	6DE2	6DE3	6DE4	6DE5	6DE6	6DE7	6DE8	6DE9	6DEA	6DEB	6DEC	6DED	6DEE	6DEF	6DF0
	Char.	拏	拏	拏	拏	拏	拏	拏	拏	拏	拏	拏	拏	拏	拏	拏	拏
CEF0	IBM	6DF1	6DF2	6DF3	6DF4	6DF5	6DF6	6DF7	6DF8	6DF9	6DFA	6DFB	6DFC	6DFD	6E41	6E42	
	Char.	拏	拏	拏	拏	拏	拏	拏	拏	拏	拏	拏	拏	拏	拏	拏	拏
CF40	IBM	6E43	6E44	6E45	6E46	6E47	6E48	6E49	6E4A	6E4B	6E4C	6E4D	6E4E	6E4F	6E50	6E51	6E52
	Char.	拏	拏	拏	拏	拏	拏	拏	拏	拏	拏	拏	拏	拏	拏	拏	拏
CF50	IBM	6E53	6E54	6E55	6E56	6E57	6E58	6E59	6E5A	6E5B	6E5C	6E5D	6E5E	6E5F	6E60	6E61	6E62
	Char.	拏	拏	拏	拏	拏	拏	拏	拏	拏	拏	拏	拏	拏	拏	拏	拏
CF60	IBM	6E63	6E64	6E65	6E66	6E67	6E68	6E69	6E6A	6E6B	6E6C	6E6D	6E6E	6E6F	6E70	6E71	6E72
	Char.	拏	拏	拏	拏	拏	拏	拏	拏	拏	拏	拏	拏	拏	拏	拏	拏
CF70	IBM	6E73	6E74	6E75	6E76	6E77	6E78	6E79	6E7A	6E7B	6E7C	6E7D	6E7E	6E7F	6E81	6E82	
	Char.	拏	拏	拏	拏	拏	拏	拏	拏	拏	拏	拏	拏	拏	拏	拏	拏
CFA0	IBM		6E83	6E84	6E85	6E86	6E87	6E88	6E89	6E8A	6E8B	6E8C	6E8D	6E8E	6E8F	6E90	6E91
	Char.		拏	拏	拏	拏	拏	拏	拏	拏	拏	拏	拏	拏	拏	拏	拏
CFB0	IBM	6E92	6E93	6E94	6E95	6E96	6E97	6E98	6E99	6E9A	6E9B	6E9C	6E9D	6E9E	6E9F	6EA0	6EA1
	Char.	拏	拏	拏	拏	拏	拏	拏	拏	拏	拏	拏	拏	拏	拏	拏	拏
CFC0	IBM	6EA2	6EA3	6EA4	6EA5	6EA6	6EA7	6EA8	6EA9	6EAA	6EAB	6EAC	6EAD	6EAE	6EAF	6EB0	6EB1
	Char.	拏	拏	拏	拏	拏	拏	拏	拏	拏	拏	拏	拏	拏	拏	拏	拏
CFD0	IBM	6EB2	6EB3	6EB4	6EB5	6EB6	6EB7	6EB8	6EB9	6EBA	6EBB	6EBC	6EBD	6EBE	6EBF	6EC0	6EC1
	Char.	拏	拏	拏	拏	拏	拏	拏	拏	拏	拏	拏	拏	拏	拏	拏	拏
CFE0	IBM	6EC2	6EC3	6EC4	6EC5	6EC6	6EC7	6EC8	6EC9	6ECA	6ECB	6ECC	6ECD	6ECE	6ECF	6ED0	6ED1
	Char.	拏	拏	拏	拏	拏	拏	拏	拏	拏	拏	拏	拏	拏	拏	拏	拏

Table B-4 Big5 à IBM Conversion Table (continued)

Big5		+ 0	+ 1	+ 2	+ 3	+ 4	+ 5	+ 6	+ 7	+ 8	+ 9	+ A	+ B	+ C	+ D	+ E	+ F
CFFO	IBM	6ED2	6ED3	6ED4	6ED5	6ED6	6ED7	6ED8	6ED9	6EDA	6EDB	6EDC	6EDD	6EDE	6EDF	6EE0	
	Char.	砒	砵	砶	砧	砫	砬	砭	砮	砯	砱	砲	砳	破	砵	砶	砷
D040	IBM	6EE1	6EE2	6EE3	6EE4	6EE5	6EE6	6EE7	6EE8	6EE9	6EEA	6EEB	6EEC	6EED	6EEE	6EEF	6EFO
	Char.	突	竝	竃	竄	竅	竆	竇	竈	竉	竊	竒	竓	竔	竕	竖	竗
D050	IBM	6EF1	6EF2	6EF3	6EF4	6EF5	6EF6	6EF7	6EF8	6EF9	6EFA	6EFB	6EFC	6EFD	6F41	6F42	6F43
	Char.	羴	考	奕	彰	耑	耑	肱	膊	肱	肌	肢	膊	肱	肤	肱	昨
D060	IBM	6F44	6F45	6F46	6F47	6F48	6F49	6F4A	6F4B	6F4C	6F4D	6F4E	6F4F	6F50	6F51	6F52	6F53
	Char.	胜	胸	肘	肱	肱	肱	肱	肱	肱	肱	肱	肱	肱	肱	肱	肱
D070	IBM	6F54	6F55	6F56	6F57	6F58	6F59	6F5A	6F5B	6F5C	6F5D	6F5E	6F5F	6F60	6F61	6F62	
	Char.	蕪	茗	菟	苦	苗	苴	茵	苳	苴	苴	苴	苴	苴	苴	苴	
DOAO	IBM		6F63	6F64	6F65	6F66	6F67	6F68	6F69	6F6A	6F6B	6F6C	6F6D	6F6E	6F6F	6F70	6F71
	Char.		莖	莨	莩	莩	莩	莩	莩	莩	莩	莩	莩	莩	莩	莩	莩
DOBO	IBM	6F72	6F73	6F74	6F75	6F76	6F77	6F78	6F79	6F7A	6F7B	6F7C	6F7D	6F7E	6F7F	6F81	6F82
	Char.	廬	匍	匍	逦	逦	逦	逦	逦	逦	逦	逦	逦	逦	逦	逦	逦
DOC0	IBM	6F83	6F84	6F85	6F86	6F87	6F88	6F89	6F8A	6F8B	6F8C	6F8D	6F8E	6F8F	6F90	6F91	6F92
	Char.	鉉	鉉	陔	陔	陔	陔	陔	陔	陔	陔	陔	陔	陔	陔	陔	陔
DOD0	IBM	6F93	6F94	6F95	6F96	6F97	6F98	6F99	6F9A	6F9B	6F9C	6F9D	6F9E	6F9F	6FA0	6FA1	6FA2
	Char.	倅	倅	倅	倅	倅	倅	倅	倅	倅	倅	倅	倅	倅	倅	倅	倅
DOEO	IBM	6FA3	6FA4	6FA5	6FA6	6FA7	6FA8	6FA9	6FAA	6FAB	6FAC	6FAD	6FAE	6FAF	6FB0	6FB1	6FB2
	Char.	蕞	清	淒	涸	淨	淦	剡	剡	剡	剡	剡	剡	剡	剡	剡	剡
DOFO	IBM	6FB3	6FB4	6FB5	6FB6	6FB7	6FB8	6FB9	6FBA	6FBB	6FBC	6FBD	6FBE	6FBF	6FC0	6FC1	
	Char.	吵	哧	哧	哧	哧	哧	哧	哧	哧	哧	哧	哧	哧	哧	哧	
D140	IBM	6FC2	6FC3	6FC4	6FC5	6FC6	6FC7	6FC8	6FC9	6FCA	6FCB	6FCC	6FCD	6FCE	6FCF	6FD0	6FD1
	Char.	啖	啖	啖	啖	啖	啖	啖	啖	啖	啖	啖	啖	啖	啖	啖	啖

Table B-4 Big5 à IBM Conversion Table (continued)

Big5		+ 0	+ 1	+ 2	+ 3	+ 4	+ 5	+ 6	+ 7	+ 8	+ 9	+ A	+ B	+ C	+ D	+ E	+ F
D150	IBM	6FD2	6FD3	6FD4	6FD5	6FD6	6FD7	6FD8	6FD9	6FDA	6FDB	6FDC	6FDD	6FDE	6FDF	6FE0	6FE1
	Char.	迺	堡	堉	埤	埤	埤	埤	埤	埤	埤	埤	埤	埤	埤	埤	埤
D160	IBM	6FE2	6FE3	6FE4	6FE5	6FE6	6FE7	6FE8	6FE9	6FEA	6FEB	6FEC	6FED	6FEE	6FEF	6FF0	6FF1
	Char.	嫫	嫫	嫫	嫫	嫫	嫫	嫫	嫫	嫫	嫫	嫫	嫫	嫫	嫫	嫫	嫫
D170	IBM	6FF2	6FF3	6FF4	6FF5	6FF6	6FF7	6FF8	6FF9	6FFA	6FFB	6FFC	6FFD	7041	7042	7043	
	Char.	崙	崙	崙	崙	崙	崙	崙	崙	崙	崙	崙	崙	崙	崙	崙	崙
D1A0	IBM		7044	7045	7046	7047	7048	7049	704A	704B	704C	704D	704E	704F	7050	7051	7052
	Char.		恁	恁	恁	恁	恁	恁	恁	恁	恁	恁	恁	恁	恁	恁	恁
D1B0	IBM	7053	7054	7055	7056	7057	7058	7059	705A	705B	705C	705D	705E	705F	7060	7061	7062
	Char.	扌	扌	扌	扌	扌	扌	扌	扌	扌	扌	扌	扌	扌	扌	扌	扌
D1C0	IBM	7063	7064	7065	7066	7067	7068	7069	706A	706B	706C	706D	706E	706F	7070	7071	7072
	Char.	扌	扌	扌	扌	扌	扌	扌	扌	扌	扌	扌	扌	扌	扌	扌	扌
D1D0	IBM	7073	7074	7075	7076	7077	7078	7079	707A	707B	707C	707D	707E	707F	7081	7082	7083
	Char.	扌	扌	扌	扌	扌	扌	扌	扌	扌	扌	扌	扌	扌	扌	扌	扌
D1E0	IBM	7084	7085	7086	7087	7088	7089	708A	708B	708C	708D	708E	708F	7090	7091	7092	7093
	Char.	扌	扌	扌	扌	扌	扌	扌	扌	扌	扌	扌	扌	扌	扌	扌	扌
D1F0	IBM	7094	7095	7096	7097	7098	7099	709A	709B	709C	709D	709E	709F	70A0	70A1	70A2	
	Char.	扌	扌	扌	扌	扌	扌	扌	扌	扌	扌	扌	扌	扌	扌	扌	扌
D240	IBM	70A3	70A4	70A5	70A6	70A7	70A8	70A9	70AA	70AB	70AC	70AD	70AE	70AF	70B0	70B1	70B2
	Char.	扌	扌	扌	扌	扌	扌	扌	扌	扌	扌	扌	扌	扌	扌	扌	扌
D250	IBM	70B3	70B4	70B5	70B6	70B7	70B8	70B9	70BA	70BB	70BC	70BD	70BE	70BF	70C0	70C1	70C2
	Char.	扌	扌	扌	扌	扌	扌	扌	扌	扌	扌	扌	扌	扌	扌	扌	扌
D260	IBM	70C3	70C4	70C5	70C6	70C7	70C8	70C9	70CA	70CB	70CC	70CD	70CE	70CF	70D0	70D1	70D2
	Char.	扌	扌	扌	扌	扌	扌	扌	扌	扌	扌	扌	扌	扌	扌	扌	扌

Table B-4 Big5 à IBM Conversion Table (continued)

Big5		+ 0	+ 1	+ 2	+ 3	+ 4	+ 5	+ 6	+ 7	+ 8	+ 9	+ A	+ B	+ C	+ D	+ E	+ F
D270	IBM	70D3	70D4	70D5	70D6	70D7	70D8	70D9	70DA	70DB	70DC	70DD	70DE	70DF	70E0	70E1	
	Char.	焯	焯	焯	焯	焯	焯	焯	焯	焯	焯	焯	焯	焯	焯	焯	
D2A0	IBM		70E2	70E3	70E4	70E5	70E6	70E7	70E8	70E9	70EA	70EB	70EC	70ED	70EE	70EF	70F0
	Char.		焯	焯	焯	焯	焯	焯	焯	焯	焯	焯	焯	焯	焯	焯	
D2B0	IBM	70F1	70F2	70F3	70F4	70F5	70F6	70F7	70F8	70F9	70FA	70FB	70FC	70FD	7141	7142	7143
	Char.	焯	焯	焯	焯	焯	焯	焯	焯	焯	焯	焯	焯	焯	焯	焯	
D2C0	IBM	7144	7145	7146	7147	7148	7149	714A	714B	714C	714D	714E	714F	7150	7151	7152	7153
	Char.	焯	焯	焯	焯	焯	焯	焯	焯	焯	焯	焯	焯	焯	焯	焯	
D2D0	IBM	7154	7155	7156	7157	7158	7159	715A	715B	715C	715D	715E	715F	7160	7161	7162	7163
	Char.	焯	焯	焯	焯	焯	焯	焯	焯	焯	焯	焯	焯	焯	焯	焯	
D2E0	IBM	7164	7165	7166	7167	7168	7169	716A	716B	716C	716D	716E	716F	7170	7171	7172	7173
	Char.	焯	焯	焯	焯	焯	焯	焯	焯	焯	焯	焯	焯	焯	焯	焯	
D2F0	IBM	7174	7175	7176	7177	7178	7179	717A	717B	717C	717D	717E	717F	7181	7182	7183	
	Char.	焯	焯	焯	焯	焯	焯	焯	焯	焯	焯	焯	焯	焯	焯	焯	
D340	IBM	7184	7185	7186	7187	7188	7189	718A	718B	718C	718D	718E	718F	7190	7191	7192	7193
	Char.	焯	焯	焯	焯	焯	焯	焯	焯	焯	焯	焯	焯	焯	焯	焯	
D350	IBM	7194	7195	7196	7197	7198	7199	719A	719B	719C	719D	719E	719F	71A0	71A1	71A2	71A3
	Char.	焯	焯	焯	焯	焯	焯	焯	焯	焯	焯	焯	焯	焯	焯	焯	
D360	IBM	71A4	71A5	71A6	71A7	71A8	71A9	71AA	71AB	71AC	71AD	71AE	71AF	71B0	71B1	71B2	71B3
	Char.	焯	焯	焯	焯	焯	焯	焯	焯	焯	焯	焯	焯	焯	焯	焯	
D370	IBM	71B4	71B5	71B6	71B7	71B8	71B9	71BA	71BB	71BC	71BD	71BE	71BF	71C0	71C1	71C2	
	Char.	焯	焯	焯	焯	焯	焯	焯	焯	焯	焯	焯	焯	焯	焯	焯	
D3A0	IBM		71C3	71C4	71C5	71C6	71C7	71C8	71C9	71CA	71CB	71CC	71CD	71CE	71CF	71D0	71D1
	Char.		焯	焯	焯	焯	焯	焯	焯	焯	焯	焯	焯	焯	焯	焯	

Table B-4 Big5 à IBM Conversion Table (continued)

Big5		+ 0	+ 1	+ 2	+ 3	+ 4	+ 5	+ 6	+ 7	+ 8	+ 9	+ A	+ B	+ C	+ D	+ E	+ F
D3B0	IBM	71D2	71D3	71D4	71D5	71D6	71D7	71D8	71D9	71DA	71DB	71DC	71D D	71D E	71DF	71E0	71E1
	Char.	菱	莽	莖	荏	蒔	茧	莛	虺	麂	虻	蚨	蚺	蚩	蛟	蚪	蚺
D3C0	IBM	71E2	71E3	71E4	71E5	71E6	71E7	71E8	71E9	71EA	71EB	71EC	71ED	71EE	71EF	71F0	71F1
	Char.	蚨	虻	蚺	蚩	蚺	蚩	蚺	蚩	蚺	蚩	蚺	蚩	蚺	蚩	蚺	蚩
D3D0	IBM	71F2	71F3	71F4	71F5	71F6	71F7	71F8	71F9	71FA	71FB	71FC	71FD	7241	7242	7243	7244
	Char.	蚺	蚩	蚺	蚩	蚺	蚩	蚺	蚩	蚺	蚩	蚺	蚩	蚺	蚩	蚺	蚩
D3E0	IBM	7245	7246	7247	7248	7249	724A	724B	724C	724D	724E	724F	7250	7251	7252	7253	7254
	Char.	豺	貍	貍	貍	貍	貍	貍	貍	貍	貍	貍	貍	貍	貍	貍	貍
D3F0	IBM	7255	7256	7257	7258	7259	725A	725B	725C	725D	725E	725F	7260	7261	7262	7263	
	Char.	迨	迨	邗	邗	邗	邗	邗	邗	邗	邗	邗	邗	邗	邗	邗	
D440	IBM	7264	7265	7266	7267	7268	7269	726A	726B	726C	726D	726E	726F	7270	7271	7272	7273
	Char.	耐	耐	耐	耐	耐	耐	耐	耐	耐	耐	耐	耐	耐	耐	耐	耐
D450	IBM	7274	7275	7276	7277	7278	7279	727A	727B	727C	727D	727E	727F	7281	7282	7283	7284
	Char.	僂	僂	僂	僂	僂	僂	僂	僂	僂	僂	僂	僂	僂	僂	僂	僂
D460	IBM	7285	7286	7287	7288	7289	728A	728B	728C	728D	728E	728F	7290	7291	7292	7293	7294
	Char.	倍	倍	倍	倍	倍	倍	倍	倍	倍	倍	倍	倍	倍	倍	倍	倍
D470	IBM	7295	7296	7297	7298	7299	729A	729B	729C	729D	729E	729F	72A0	72A1	72A2	72A3	
	Char.	歷	嘖	嘖	嘖	嘖	嘖	嘖	嘖	嘖	嘖	嘖	嘖	嘖	嘖	嘖	
D4A0	IBM		72A4	72A5	72A6	72A7	72A8	72A9	72AA	72AB	72AC	72AD	72AE	72AF	72B0	72B1	72B2
	Char.		嘖	嘖	嘖	嘖	嘖	嘖	嘖	嘖	嘖	嘖	嘖	嘖	嘖	嘖	嘖
D4B0	IBM	72B3	72B4	72B5	72B6	72B7	72B8	72B9	72BA	72BB	72BC	72BD	72BE	72BF	72C0	72C1	72C2
	Char.	執	埜	埜	埜	埜	埜	埜	埜	埜	埜	埜	埜	埜	埜	埜	埜

Table B-4 Big5 à IBM Conversion Table (continued)

Big5		+ 0	+ 1	+ 2	+ 3	+ 4	+ 5	+ 6	+ 7	+ 8	+ 9	+ A	+ B	+ C	+ D	+ E	+ F
D4C0	IBM	72C3	72C4	72C5	72C6	72C7	72C8	72C9	72CA	72CB	72CC	72CD	72CE	72CF	72D0	72D1	72D2
	Char.	堧	堩	堪	堽	堾	堿	堻	堼	堽	堾	堿	堻	堼	堽	堿	堻
D4D0	IBM	72D3	72D4	72D5	72D6	72D7	72D8	72D9	72DA	72DB	72DC	72DD	72DE	72DF	72E0	72E1	72E2
	Char.	媓	媔	媕	媖	媗	媘	媙	媚	媛	媜	媝	媞	媟	媠	媡	媢
D4E0	IBM	72E3	72E4	72E5	72E6	72E7	72E8	72E9	72EA	72EB	72EC	72ED	72EE	72EF	72F0	72F1	72F2
	Char.	媣	媕	媖	媗	媘	媙	媚	媛	媜	媝	媞	媟	媠	媡	媢	媣
D4F0	IBM	72F3	72F4	72F5	72F6	72F7	72F8	72F9	72FA	72FB	72FC	72FD	7341	7342	7343	7344	
	Char.	嶺	嶸	嶹	嶺	嶻	嶼	嶽	嶾	嶿	嶽	嶾	嶿	嶽	嶾	嶿	嶽
D540	IBM	7345	7346	7347	7348	7349	734A	734B	734C	734D	734E	734F	7350	7351	7352	7353	7354
	Char.	嶻	嶼	嶽	嶾	嶿	嶽	嶾	嶿	嶽	嶾	嶿	嶽	嶾	嶿	嶽	嶾
D550	IBM	7355	7356	7357	7358	7359	735A	735B	735C	735D	735E	735F	7360	7361	7362	7363	7364
	Char.	憇	憈	憉	憊	憋	憌	憍	憎	憏	憐	憑	憒	憓	憔	憕	憖
D560	IBM	7365	7366	7367	7368	7369	736A	736B	736C	736D	736E	736F	7370	7371	7372	7373	7374
	Char.	憇	憈	憉	憊	憋	憌	憍	憎	憏	憐	憑	憒	憓	憔	憕	憖
D570	IBM	7375	7376	7377	7378	7379	737A	737B	737C	737D	737E	737F	7381	7382	7383	7384	
	Char.	擧	擨	擩	擪	擫	擬	擭	擯	擰	擱	擲	擳	擴	擵	擶	
D5A0	IBM		7385	7386	7387	7388	7389	738A	738B	738C	738D	738E	738F	7390	7391	7392	7393
	Char.		擷	擸	擹	擺	擻	擼	擽	擾	擿	擾	擿	擺	擻	擼	擽
D5B0	IBM	7394	7395	7396	7397	7398	7399	739A	739B	739C	739D	739E	739F	73A0	73A1	73A2	73A3
	Char.	擿	擺	擻	擼	擽	擾	擿	擺	擻	擼	擽	擾	擿	擺	擻	擼
D5C0	IBM	73A4	73A5	73A6	73A7	73A8	73A9	73AA	73AB	73AC	73AD	73AE	73AF	73B0	73B1	73B2	73B3
	Char.	擿	擺	擻	擼	擽	擾	擿	擺	擻	擼	擽	擾	擿	擺	擻	擼

Table B-4 Big5 à IBM Conversion Table (continued)

Big5		+ 0	+ 1	+ 2	+ 3	+ 4	+ 5	+ 6	+ 7	+ 8	+ 9	+ A	+ B	+ C	+ D	+ E	+ F
D5D0	IBM	73B4	73B5	73B6	73B7	73B8	73B9	73BA	73BB	73BC	73BD	73BE	73BF	73C0	73C1	73C2	73C3
	Char.	稀	穉	楸	楮	槲	奎	欸	畝	欸	欸	殍	殍	殍	殍	殍	氫
D5E0	IBM	73C4	73C5	73C6	73C7	73C8	73C9	73CA	73CB	73CC	73CD	73CE	73CF	73D0	73D1	73D2	73D3
	Char.	淀	涓	漣	涇	澁	津	凌	減	凍	凍	漬	澆	澆	澆	澆	淖
D5F0	IBM	73D4	73D5	73D6	73D7	73D8	73D9	73DA	73DB	73DC	73DD	73DE	73DF	73E0	73E1	73E2	
	Char.	渣	淥	淵	泥	澗	澗	澗	澗	澗	澗	澗	澗	澗	澗	澗	澗
D640	IBM	73E3	73E4	73E5	73E6	73E7	73E8	73E9	73EA	73EB	73EC	73ED	73EE	73EF	73F0	73F1	73F2
	Char.	滄	滄	滄	滄	滄	滄	滄	滄	滄	滄	滄	滄	滄	滄	滄	滄
D650	IBM	73F3	73F4	73F5	73F6	73F7	73F8	73F9	73FA	73FB	73FC	73FD	7441	7442	7443	7444	7445
	Char.	焯	焯	焯	焯	焯	焯	焯	焯	焯	焯	焯	焯	焯	焯	焯	焯
D660	IBM	7446	7447	7448	7449	744A	744B	744C	744D	744E	744F	7450	7451	7452	7453	7454	7455
	Char.	猝	猗	猗	猗	猗	猗	猗	猗	猗	猗	猗	猗	猗	猗	猗	猗
D670	IBM	7456	7457	7458	7459	745A	745B	745C	745D	745E	745F	7460	7461	7462	7463	7464	
	Char.	斑	琇	琇	琇	琇	琇	琇	琇	琇	琇	琇	琇	琇	琇	琇	琇
D6A0	IBM		7465	7466	7467	7468	7469	746A	746B	746C	746D	746E	746F	7470	7471	7472	7473
	Char.		痘	痂	疹	痂	餅	毗	汪	睽	睽	睽	睽	睽	睽	睽	睽
D6B0	IBM	7474	7475	7476	7477	7478	7479	747A	747B	747C	747D	747E	747F	7481	7482	7483	7484
	Char.	瞿	瞿	瞿	硃	硃	硃	硃	硃	硃	硃	硃	硃	硃	硃	硃	硃
D6C0	IBM	7485	7486	7487	7488	7489	748A	748B	748C	748D	748E	748F	7490	7491	7492	7493	7494
	Char.	裯	裯	裯	裯	裯	裯	裯	裯	裯	裯	裯	裯	裯	裯	裯	裯
D6D0	IBM	7495	7496	7497	7498	7499	749A	749B	749C	749D	749E	749F	74A0	74A1	74A2	74A3	74A4
	Char.	篋	篋	篋	篋	篋	篋	篋	篋	篋	篋	篋	篋	篋	篋	篋	篋
D6E0	IBM	74A5	74A6	74A7	74A8	74A9	74AA	74AB	74AC	74AD	74AE	74AF	74B0	74B1	74B2	74B3	74B4
	Char.	絺	絺	紵	紵	紵	紵	紵	紵	紵	紵	紵	紵	紵	紵	紵	紵

Table B-4 Big5 à IBM Conversion Table (continued)

Big5		+ 0	+ 1	+ 2	+ 3	+ 4	+ 5	+ 6	+ 7	+ 8	+ 9	+ A	+ B	+ C	+ D	+ E	+ F
D6F0	IBM	74B5	74B6	74B7	74B8	74B9	74BA	74BB	74BC	74BD	74BE	74BF	74C0	74C1	74C2	74C3	
	Char.	紉	隼	業	犖	羝	蕘	翊	羝	鞞	狝	獬	斐	蓼	栩	梘	
D740	IBM	74C4	74C5	74C6	74C7	74C8	74C9	74CA	74CB	74CC	74CD	74CE	74CF	74D0	74D1	74D2	74D3
	Char.	糲	稭	駑	聘	聊	腕	腴	脉	脛	脛	脛	脛	脛	脛	脛	脛
D750	IBM	74D4	74D5	74D6	74D7	74D8	74D9	74DA	74DB	74DC	74DD	74DE	74DF	74E0	74E1	74E2	74E3
	Char.	脛	脛	脛	脛	脛	脛	脛	脛	脛	脛	脛	脛	脛	脛	脛	脛
D760	IBM	74E4	74E5	74E6	74E7	74E8	74E9	74EA	74EB	74EC	74ED	74EE	74EF	74F0	74F1	74F2	74F3
	Char.	莸	莸	莸	莸	莸	莸	莸	莸	莸	莸	莸	莸	莸	莸	莸	莸
D770	IBM	74F4	74F5	74F6	74F7	74F8	74F9	74FA	74FB	74FC	74FD	7541	7542	7543	7544	7545	
	Char.	莸	莸	莸	莸	莸	莸	莸	莸	莸	莸	莸	莸	莸	莸	莸	
D7A0	IBM		7546	7547	7548	7549	754A	754B	754C	754D	754E	754F	7550	7551	7552	7553	7554
	Char.		虻	虻	虻	虻	虻	虻	虻	虻	虻	虻	虻	虻	虻	虻	虻
D7B0	IBM	7555	7556	7557	7558	7559	755A	755B	755C	755D	755E	755F	7560	7561	7562	7563	7564
	Char.	虻	虻	虻	虻	虻	虻	虻	虻	虻	虻	虻	虻	虻	虻	虻	虻
D7C0	IBM	7565	7566	7567	7568	7569	756A	756B	756C	756D	756E	756F	7570	7571	7572	7573	7574
	Char.	虻	虻	虻	虻	虻	虻	虻	虻	虻	虻	虻	虻	虻	虻	虻	虻
D7D0	IBM	7575	7576	7577	7578	7579	757A	757B	757C	757D	757E	757F	7581	7582	7583	7584	7585
	Char.	虻	虻	虻	虻	虻	虻	虻	虻	虻	虻	虻	虻	虻	虻	虻	虻
D7E0	IBM	7586	7587	7588	7589	758A	758B	758C	758D	758E	758F	7590	7591	7592	7593	7594	7595
	Char.	虻	虻	虻	虻	虻	虻	虻	虻	虻	虻	虻	虻	虻	虻	虻	虻
D7F0	IBM	7596	7597	7598	7599	759A	759B	759C	759D	759E	759F	75A0	75A1	75A2	75A3	75A4	
	Char.	虻	虻	虻	虻	虻	虻	虻	虻	虻	虻	虻	虻	虻	虻	虻	
D840	IBM	75A5	75A6	75A7	75A8	75A9	75AA	75AB	75AC	75AD	75AE	75AF	75B0	75B1	75B2	75B3	75B4
	Char.	虻	虻	虻	虻	虻	虻	虻	虻	虻	虻	虻	虻	虻	虻	虻	虻

Table B-4 Big5 à IBM Conversion Table (continued)

Big5		+ 0	+ 1	+ 2	+ 3	+ 4	+ 5	+ 6	+ 7	+ 8	+ 9	+ A	+ B	+ C	+ D	+ E	+ F
D850	IBM	75B5	75B6	75B7	75B8	75B9	75BA	75BB	75BC	75BD	75BE	75BF	75C0	75C1	75C2	75C3	75C4
	Char.	廋	俗	催	儻	傥	儻	儻	儻	儻	儻	儻	儻	儻	儻	儻	儻
D860	IBM	75C5	75C6	75C7	75C8	75C9	75CA	75CB	75CC	75CD	75CE	75CF	75D0	75D1	75D2	75D3	75D4
	Char.	舛	滄	芻	芻	麻	眞	暗	曉	嘍	嘍	啣	啣	啣	啣	啣	啣
D870	IBM	75D5	75D6	75D7	75D8	75D9	75DA	75DB	75DC	75DD	75DE	75DF	75E0	75E1	75E2	75E3	
	Char.	喵	噤	噤	嗜	噤	噤	噤	噤	噤	噤	噤	噤	噤	噤	噤	
D8A0	IBM		75E4	75E5	75E6	75E7	75E8	75E9	75EA	75EB	75EC	75ED	75EE	75EF	75F0	75F1	75F2
	Char.		堙	堙	堙	堙	堙	堙	堙	堙	堙	堙	堙	堙	堙	堙	堙
D8B0	IBM	75F3	75F4	75F5	75F6	75F7	75F8	75F9	75FA	75FB	75FC	75FD	7641	7642	7643	7644	7645
	Char.	颯	堙	瑜	湮	冪	媯	媯	媯	媯	媯	媯	媯	媯	媯	媯	媯
D8C0	IBM	7646	7647	7648	7649	764A	764B	764C	764D	764E	764F	7650	7651	7652	7653	7654	7655
	Char.	媯	媯	媯	媯	媯	媯	媯	媯	媯	媯	媯	媯	媯	媯	媯	媯
D8D0	IBM	7656	7657	7658	7659	765A	765B	765C	765D	765E	765F	7660	7661	7662	7663	7664	7665
	Char.	爲	窰	窰	窰	窰	窰	窰	窰	窰	窰	窰	窰	窰	窰	窰	窰
D8E0	IBM	7666	7667	7668	7669	766A	766B	766C	766D	766E	766F	7670	7671	7672	7673	7674	7675
	Char.	嶠	嶠	嶠	嶠	嶠	嶠	嶠	嶠	嶠	嶠	嶠	嶠	嶠	嶠	嶠	嶠
D8F0	IBM	7676	7677	7678	7679	767A	767B	767C	767D	767E	767F	7681	7682	7683	7684	7685	
	Char.	崱	崱	嶠	嶠	嶠	假	徒	律	恣	恣	恣	恣	恣	恣	恣	
D940	IBM	7686	7687	7688	7689	768A	768B	768C	768D	768E	768F	7690	7691	7692	7693	7694	7695
	Char.	憚	愾	愾	憚	憚	憚	憚	憚	憚	憚	憚	憚	憚	憚	憚	憚
D950	IBM	7696	7697	7698	7699	769A	769B	769C	769D	769E	769F	76A0	76A1	76A2	76A3	76A4	76A5
	Char.	援	扞	擊	擗	擗	擗	擗	擗	擗	擗	擗	擗	擗	擗	擗	擗
D960	IBM	76A6	76A7	76A8	76A9	76AA	76AB	76AC	76AD	76AE	76AF	76B0	76B1	76B2	76B3	76B4	76B5
	Char.	揲	揲	揲	揲	揲	揲	揲	揲	揲	揲	揲	揲	揲	揲	揲	揲

Table B-4 Big5 à IBM Conversion Table (continued)

Big5		+ 0	+ 1	+ 2	+ 3	+ 4	+ 5	+ 6	+ 7	+ 8	+ 9	+ A	+ B	+ C	+ D	+ E	+ F
D970	IBM	76B6	76B7	76B8	76B9	76BA	76BB	76BC	76BD	76BE	76BF	76C0	76C1	76C2	76C3	76C4	
	Char.	插	搨	鼓	敲	斂	斂	斂	斂	斂	斂	斂	斂	斂	斂	斂	
D9A0	IBM		76C5	76C6	76C7	76C8	76C9	76CA	76CB	76CC	76CD	76CE	76CF	76D0	76D1	76D2	76D3
	Char.		碗	晬	晬	晬	晬	晬	晬	晬	晬	晬	晬	晬	晬	晬	
D9B0	IBM	76D4	76D5	76D6	76D7	76D8	76D9	76DA	76DB	76DC	76DD	76DE	76DF	76E0	76E1	76E2	76E3
	Char.	椶	椶	椶	椶	椶	椶	椶	椶	椶	椶	椶	椶	椶	椶	椶	
D9C0	IBM	76E4	76E5	76E6	76E7	76E8	76E9	76EA	76EB	76EC	76ED	76EE	76EF	76F0	76F1	76F2	76F3
	Char.	椶	椶	椶	椶	椶	椶	椶	椶	椶	椶	椶	椶	椶	椶	椶	
D9D0	IBM	76F4	76F5	76F6	76F7	76F8	76F9	76FA	76FB	76FC	76FD	7741	7742	7743	7744	7745	7746
	Char.	椶	椶	椶	椶	椶	椶	椶	椶	椶	椶	椶	椶	椶	椶	椶	
D9E0	IBM	7747	7748	7749	774A	774B	774C	774D	774E	774F	7750	7751	7752	7753	7754	7755	7756
	Char.	椶	椶	椶	椶	椶	椶	椶	椶	椶	椶	椶	椶	椶	椶	椶	
D9F0	IBM	7757	7758	7759	775A	775B	775C	775D	775E	775F	7760	7761	7762	7763	7764	7765	
	Char.	椶	椶	椶	椶	椶	椶	椶	椶	椶	椶	椶	椶	椶	椶	椶	
DA40	IBM	7766	7767	7768	7769	776A	776B	776C	776D	776E	776F	7770	7771	7772	7773	7774	7775
	Char.	椶	椶	椶	椶	椶	椶	椶	椶	椶	椶	椶	椶	椶	椶	椶	
DA50	IBM	7776	7777	7778	7779	777A	777B	777C	777D	777E	777F	7781	7782	7783	7784	7785	7786
	Char.	椶	椶	椶	椶	椶	椶	椶	椶	椶	椶	椶	椶	椶	椶	椶	
DA60	IBM	7787	7788	7789	778A	778B	778C	778D	778E	778F	7790	7791	7792	7793	7794	7795	7796
	Char.	椶	椶	椶	椶	椶	椶	椶	椶	椶	椶	椶	椶	椶	椶	椶	
DA70	IBM	7797	7798	7799	779A	779B	779C	779D	779E	779F	77A0	77A1	77A2	77A3	77A4	77A5	
	Char.	椶	椶	椶	椶	椶	椶	椶	椶	椶	椶	椶	椶	椶	椶	椶	
DAA0	IBM		77A6	77A7	77A8	77A9	77AA	77AB	77AC	77AD	77AE	77AF	77B0	77B1	77B2	77B3	77B4
	Char.		椶	椶	椶	椶	椶	椶	椶	椶	椶	椶	椶	椶	椶	椶	

Table B-4 Big5 à IBM Conversion Table (continued)

Big5		+ 0	+ 1	+ 2	+ 3	+ 4	+ 5	+ 6	+ 7	+ 8	+ 9	+ A	+ B	+ C	+ D	+ E	+ F
DAB0	IBM	77B5	77B6	77B7	77B8	77B9	77BA	77BB	77BC	77BD	77BE	77BF	77C0	77C1	77C2	77C3	77C4
	Char.	痒	痛	瘡	癢	瘡	瘡	瘡	痲	疥	疥	疥	睇	睇	睇	睇	睇
DAC0	IBM	77C5	77C6	77C7	77C8	77C9	77CA	77CB	77CC	77CD	77CE	77CF	77D0	77D1	77D2	77D3	77D4
	Char.	睇	睇	睇	睇	睇	硠	硠	硠	硠	硠	硠	硠	硠	硠	硠	硠
DAD0	IBM	77D5	77D6	77D7	77D8	77D9	77DA	77DB	77DC	77DD	77DE	77DF	77E0	77E1	77E2	77E3	77E4
	Char.	硠	硠	硠	硠	硠	硠	稂	稂	稂	稂	稂	稂	稂	稂	稂	稂
DAE0	IBM	77E5	77E6	77E7	77E8	77E9	77EA	77EB	77EC	77ED	77EE	77EF	77F0	77F1	77F2	77F3	77F4
	Char.	筭	筭	筭	筭	筭	筭	筭	筭	筭	筭	筭	筭	筭	筭	筭	筭
DAF0	IBM	77F5	77F6	77F7	77F8	77F9	77FA	77FB	77FC	77FD	7841	7842	7843	7844	7845	7846	
	Char.	綢	綢	綢	綢	綢	綢	綢	綢	綢	綢	綢	綢	綢	綢	綢	
DB40	IBM	7847	7848	7849	784A	784B	784C	784D	784E	784F	7850	7851	7852	7853	7854	7855	7856
	Char.	孛	孛	孛	孛	孛	孛	孛	孛	孛	孛	孛	孛	孛	孛	孛	孛
DB50	IBM	7857	7858	7859	785A	785B	785C	785D	785E	785F	7860	7861	7862	7863	7864	7865	7866
	Char.	脛	脛	脛	脛	脛	脛	脛	脛	脛	脛	脛	脛	脛	脛	脛	脛
DB60	IBM	7867	7868	7869	786A	786B	786C	786D	786E	786F	7870	7871	7872	7873	7874	7875	7876
	Char.	菀	菀	菀	菀	菀	菀	菀	菀	菀	菀	菀	菀	菀	菀	菀	菀
DB70	IBM	7877	7878	7879	787A	787B	787C	787D	787E	787F	7881	7882	7883	7884	7885	7886	
	Char.	菘	菘	菘	菘	菘	菘	菘	菘	菘	菘	菘	菘	菘	菘	菘	
DBA0	IBM		7887	7888	7889	788A	788B	788C	788D	788E	788F	7890	7891	7892	7893	7894	7895
	Char.		菘	菘	菘	菘	菘	菘	菘	菘	菘	菘	菘	菘	菘	菘	菘
DBB0	IBM	7896	7897	7898	7899	789A	789B	789C	789D	789E	789F	78A0	78A1	78A2	78A3	78A4	78A5
	Char.	菘	菘	菘	菘	菘	菘	菘	菘	菘	菘	菘	菘	菘	菘	菘	菘
DBC0	IBM	78A6	78A7	78A8	78A9	78AA	78AB	78AC	78AD	78AE	78AF	78B0	78B1	78B2	78B3	78B4	78B5
	Char.	岬	衞	衞	衞	衞	衞	衞	衞	衞	衞	衞	衞	衞	衞	衞	衞

Table B-4 Big5 à IBM Conversion Table (continued)

Big5		+ 0	+ 1	+ 2	+ 3	+ 4	+ 5	+ 6	+ 7	+ 8	+ 9	+ A	+ B	+ C	+ D	+ E	+ F
DBD0	IBM	78B6	78B7	78B8	78B9	78BA	78BB	78BC	78BD	78BE	78BF	78C0	78C1	78C2	78C3	78C4	78C5
	Char.	覘	覘	覘	觥	觥	觥	詎	誑	誑	誑	詎	詎	詎	詎	詎	詎
DBE0	IBM	78C6	78C7	78C8	78C9	78CA	78CB	78CC	78CD	78CE	78CF	78D0	78D1	78D2	78D3	78D4	78D5
	Char.	訾	訛	訛	訛	訛	貍	貍	貍	貍	貍	貍	賁	賁	賁	賁	賁
DBF0	IBM	78D6	78D7	78D8	78D9	78DA	78DB	78DC	78DD	78DE	78DF	78E0	78E1	78E2	78E3	78E4	
	Char.	躡	躡	躡	躡	躡	躡	躡	躡	躡	躡	躡	躡	躡	躡	躡	
DC40	IBM	78E5	78E6	78E7	78E8	78E9	78EA	78EB	78EC	78ED	78EE	78EF	78F0	78F1	78F2	78F3	78F4
	Char.	軹	軹	軹	軹	軹	軹	軹	軹	軹	軹	軹	軹	軹	軹	軹	軹
DC50	IBM	78F5	78F6	78F7	78F8	78F9	78FA	78FB	78FC	78FD	7941	7942	7943	7944	7945	7946	7947
	Char.	鄆	鄆	鄆	鄆	鄆	鄆	鄆	鄆	鄆	鄆	鄆	鄆	鄆	鄆	鄆	鄆
DC60	IBM	7948	7949	794A	794B	794C	794D	794E	794F	7950	7951	7952	7953	7954	7955	7956	7957
	Char.	鈇	鈇	鈇	鈇	鈇	鈇	鈇	鈇	鈇	鈇	鈇	鈇	鈇	鈇	鈇	鈇
DC70	IBM	7958	7959	795A	795B	795C	795D	795E	795F	7960	7961	7962	7963	7964	7965	7966	
	Char.	鈇	鈇	鈇	鈇	鈇	鈇	鈇	鈇	鈇	鈇	鈇	鈇	鈇	鈇	鈇	
DCA0	IBM		7967	7968	7969	796A	796B	796C	796D	796E	796F	7970	7971	7972	7973	7974	7975
	Char.		鈇	鈇	鈇	鈇	鈇	鈇	鈇	鈇	鈇	鈇	鈇	鈇	鈇	鈇	鈇
DCB0	IBM	7976	7977	7978	7979	797A	797B	797C	797D	797E	797F	7981	7982	7983	7984	7985	7986
	Char.	備	備	備	備	備	備	備	備	備	備	備	備	備	備	備	備
DCC0	IBM	7987	7988	7989	798A	798B	798C	798D	798E	798F	7990	7991	7992	7993	7994	7995	7996
	Char.	備	備	備	備	備	備	備	備	備	備	備	備	備	備	備	備
DCD0	IBM	7997	7998	7999	799A	799B	799C	799D	799E	799F	79A0	79A1	79A2	79A3	79A4	79A5	79A6
	Char.	嘔	嘔	嘔	嘔	嘔	嘔	嘔	嘔	嘔	嘔	嘔	嘔	嘔	嘔	嘔	嘔

Table B-4 Big5 à IBM Conversion Table (continued)

Big5		+ 0	+ 1	+ 2	+ 3	+ 4	+ 5	+ 6	+ 7	+ 8	+ 9	+ A	+ B	+ C	+ D	+ E	+ F
DCE0	IBM	79A7	79A8	79A9	79AA	79AB	79AC	79AD	79AE	79AF	79B0	79B1	79B2	79B3	79B4	79B5	79B6
	Char.	嚙	圖	塤	塏	塐	塑	塒	塓	塔	塕	塖	塗	塘	塙	塚	塛
DCF0	IBM	79B7	79B8	79B9	79BA	79BB	79BC	79BD	79BE	79BF	79C0	79C1	79C2	79C3	79C4	79C5	
	Char.	塞	塟	塠	塡	塢	塣	塤	塥	塦	塧	塨	塩	塪	填	塬	
DD40	IBM	79C6	79C7	79C8	79C9	79CA	79CB	79CC	79CD	79CE	79CF	79D0	79D1	79D2	79D3	79D4	79D5
	Char.	塮	塯	塰	塱	塲	塵	塶	塷	塸	塹	塺	塻	塼	塽	塾	塿
DD50	IBM	79D6	79D7	79D8	79D9	79DA	79DB	79DC	79DD	79DE	79DF	79E0	79E1	79E2	79E3	79E4	79E5
	Char.	塿	塽	塾	塿	塺	塻	塼	塽	塾	塿	塽	塾	塿	塺	塻	塼
DD60	IBM	79E6	79E7	79E8	79E9	79EA	79EB	79EC	79ED	79EE	79EF	79F0	79F1	79F2	79F3	79F4	79F5
	Char.	塽	塾	塿	塺	塻	塼	塽	塾	塿	塺	塻	塼	塽	塾	塿	塺
DD70	IBM	79F6	79F7	79F8	79F9	79FA	79FB	79FC	79FD	7A41	7A42	7A43	7A44	7A45	7A46	7A47	
	Char.	塿	塽	塾	塿	塺	塻	塼	塽	塾	塿	塺	塻	塼	塽	塾	塿
DDA0	IBM		7A48	7A49	7A4A	7A4B	7A4C	7A4D	7A4E	7A4F	7A50	7A51	7A52	7A53	7A54	7A55	7A56
	Char.		塿	塽	塾	塿	塺	塻	塼	塽	塾	塿	塺	塻	塼	塽	塾
DDB0	IBM	7A57	7A58	7A59	7A5A	7A5B	7A5C	7A5D	7A5E	7A5F	7A60	7A61	7A62	7A63	7A64	7A65	7A66
	Char.	塿	塽	塾	塿	塺	塻	塼	塽	塾	塿	塺	塻	塼	塽	塾	塿
DDC0	IBM	7A67	7A68	7A69	7A6A	7A6B	7A6C	7A6D	7A6E	7A6F	7A70	7A71	7A72	7A73	7A74	7A75	7A76
	Char.	塿	塽	塾	塿	塺	塻	塼	塽	塾	塿	塺	塻	塼	塽	塾	塿
DDD0	IBM	7A77	7A78	7A79	7A7A	7A7B	7A7C	7A7D	7A7E	7A7F	7A81	7A82	7A83	7A84	7A85	7A86	7A87
	Char.	塿	塽	塾	塿	塺	塻	塼	塽	塾	塿	塺	塻	塼	塽	塾	塿
DDE0	IBM	7A88	7A89	7A8A	7A8B	7A8C	7A8D	7A8E	7A8F	7A90	7A91	7A92	7A93	7A94	7A95	7A96	7A97
	Char.	塿	塽	塾	塿	塺	塻	塼	塽	塾	塿	塺	塻	塼	塽	塾	塿
DDF0	IBM	7A98	7A99	7A9A	7A9B	7A9C	7A9D	7A9E	7A9F	7AA0	7AA1	7AA2	7AA3	7AA4	7AA5	7AA6	
	Char.	塿	塽	塾	塿	塺	塻	塼	塽	塾	塿	塺	塻	塼	塽	塾	塿

Table B-4 Big5 à IBM Conversion Table (continued)

Big5		+ 0	+ 1	+ 2	+ 3	+ 4	+ 5	+ 6	+ 7	+ 8	+ 9	+ A	+ B	+ C	+ D	+ E	+ F
DE40	IBM	7AA7	7AA8	7AA9	7AAA	7AAB	7AAC	7AAD	7AAE	7AAF	7AB0	7AB1	7AB2	7AB3	7AB4	7AB5	7AB6
	Char.	漣	氾	氾	漚	漚	漚	漚	漚	漚	漚	漚	漚	漚	漚	漚	漚
DE50	IBM	7AB7	7AB8	7AB9	7ABA	7ABB	7ABC	7ABD	7ABE	7ABF	7AC0	7AC1	7AC2	7AC3	7AC4	7AC5	7AC6
	Char.	溥	溥	溥	溥	溥	溥	溥	溥	溥	溥	溥	溥	溥	溥	溥	溥
DE60	IBM	7AC7	7AC8	7AC9	7ACA	7ACB	7ACC	7ACD	7ACE	7ACF	7AD0	7AD1	7AD2	7AD3	7AD4	7AD5	7AD6
	Char.	淮	淮	淮	淮	淮	淮	淮	淮	淮	淮	淮	淮	淮	淮	淮	淮
DE70	IBM	7AD7	7AD8	7AD9	7ADA	7ADB	7ADC	7ADD	7ADE	7ADF	7AE0	7AE1	7AE2	7AE3	7AE4	7AE5	
	Char.	熾	熾	熾	熾	熾	熾	熾	熾	熾	熾	熾	熾	熾	熾	熾	
DEA0	IBM		7AE6	7AE7	7AE8	7AE9	7AEA	7AEB	7AEC	7AED	7AEE	7AEF	7AF0	7AF1	7AF2	7AF3	7AF4
	Char.		熾	熾	熾	熾	熾	熾	熾	熾	熾	熾	熾	熾	熾	熾	熾
DEB0	IBM	7AF5	7AF6	7AF7	7AF8	7AF9	7AFA	7AFB	7AFC	7AFD	7B41	7B42	7B43	7B44	7B45	7B46	7B47
	Char.	獠	獠	獠	獠	獠	獠	獠	獠	獠	獠	獠	獠	獠	獠	獠	獠
DEC0	IBM	7B48	7B49	7B4A	7B4B	7B4C	7B4D	7B4E	7B4F	7B50	7B51	7B52	7B53	7B54	7B55	7B56	7B57
	Char.	瓠	瓠	瓠	瓠	瓠	瓠	瓠	瓠	瓠	瓠	瓠	瓠	瓠	瓠	瓠	瓠
DED0	IBM	7B58	7B59	7B5A	7B5B	7B5C	7B5D	7B5E	7B5F	7B60	7B61	7B62	7B63	7B64	7B65	7B66	7B67
	Char.	瘡	瘡	瘡	瘡	瘡	瘡	瘡	瘡	瘡	瘡	瘡	瘡	瘡	瘡	瘡	瘡
DEE0	IBM	7B68	7B69	7B6A	7B6B	7B6C	7B6D	7B6E	7B6F	7B70	7B71	7B72	7B73	7B74	7B75	7B76	7B77
	Char.	論	論	論	論	論	論	論	論	論	論	論	論	論	論	論	論
DEFO	IBM	7B78	7B79	7B7A	7B7B	7B7C	7B7D	7B7E	7B7F	7B81	7B82	7B83	7B84	7B85	7B86	7B87	
	Char.	碚	碚	碚	碚	碚	碚	碚	碚	碚	碚	碚	碚	碚	碚	碚	
DF40	IBM	7B88	7B89	7B8A	7B8B	7B8C	7B8D	7B8E	7B8F	7B90	7B91	7B92	7B93	7B94	7B95	7B96	7B97
	Char.	籜	籜	籜	籜	籜	籜	籜	籜	籜	籜	籜	籜	籜	籜	籜	籜
DF50	IBM	7B98	7B99	7B9A	7B9B	7B9C	7B9D	7B9E	7B9F	7BA0	7BA1	7BA2	7BA3	7BA4	7BA5	7BA6	7BA7
	Char.	箒	箒	箒	箒	箒	箒	箒	箒	箒	箒	箒	箒	箒	箒	箒	箒

Table B-4 Big5 à IBM Conversion Table (continued)

Big5		+ 0	+ 1	+ 2	+ 3	+ 4	+ 5	+ 6	+ 7	+ 8	+ 9	+ A	+ B	+ C	+ D	+ E	+ F
DF60	IBM	7BA8	7BA9	7BAA	7BAB	7BAC	7BAD	7BAE	7BAF	7BB0	7BB1	7BB2	7BB3	7BB4	7BB5	7BB6	7BB7
	Char.	綃	綉	綌	綍	綎	綏	綒	經	綔	綕	綖	綗	綘	継	続	綛
DF70	IBM	7BB8	7BB9	7BBA	7BBB	7BBC	7BBD	7BBE	7BBF	7BC0	7BC1	7BC2	7BC3	7BC4	7BC5	7BC6	
	Char.	綜	綝	綞	綟	綠	綡	綢	綣	綤	綦	綧	綨	綩	綪	綫	
DFA0	IBM		7BC7	7BC8	7BC9	7BCA	7BCB	7BCC	7BCD	7BCE	7BCF	7BD0	7BD1	7BD2	7BD3	7BD4	7BD5
	Char.		綬	維	綮	綯	綰	綰	綯	綰	綯	綰	綯	綰	綯	綰	綯
DFB0	IBM	7BD6	7BD7	7BD8	7BD9	7BDA	7BDB	7BDC	7BDD	7BDE	7BDF	7BE0	7BE1	7BE2	7BE3	7BE4	7BE5
	Char.	綰	綰	綰	綰	綰	綰	綰	綰	綰	綰	綰	綰	綰	綰	綰	綰
DFC0	IBM	7BE6	7BE7	7BE8	7BE9	7BEA	7BEB	7BEC	7BED	7BEE	7BEF	7BF0	7BF1	7BF2	7BF3	7BF4	7BF5
	Char.	綰	綰	綰	綰	綰	綰	綰	綰	綰	綰	綰	綰	綰	綰	綰	綰
DFD0	IBM	7BF6	7BF7	7BF8	7BF9	7BFA	7BFB	7BFC	7BFD	7C41	7C42	7C43	7C44	7C45	7C46	7C47	7C48
	Char.	綰	綰	綰	綰	綰	綰	綰	綰	綰	綰	綰	綰	綰	綰	綰	綰
DFE0	IBM	7C49	7C4A	7C4B	7C4C	7C4D	7C4E	7C4F	7C50	7C51	7C52	7C53	7C54	7C55	7C56	7C57	7C58
	Char.	綰	綰	綰	綰	綰	綰	綰	綰	綰	綰	綰	綰	綰	綰	綰	綰
DFFO	IBM	7C59	7C5A	7C5B	7C5C	7C5D	7C5E	7C5F	7C60	7C61	7C62	7C63	7C64	7C65	7C66	7C67	
	Char.	綰	綰	綰	綰	綰	綰	綰	綰	綰	綰	綰	綰	綰	綰	綰	
E040	IBM	7C68	7C69	7C6A	7C6B	7C6C	7C6D	7C6E	7C6F	7C70	7C71	7C72	7C73	7C74	7C75	7C76	7C77
	Char.	綰	綰	綰	綰	綰	綰	綰	綰	綰	綰	綰	綰	綰	綰	綰	綰
E050	IBM	7C78	7C79	7C7A	7C7B	7C7C	7C7D	7C7E	7C7F	7C81	7C82	7C83	7C84	7C85	7C86	7C87	7C88
	Char.	綰	綰	綰	綰	綰	綰	綰	綰	綰	綰	綰	綰	綰	綰	綰	綰
E060	IBM	7C89	7C8A	7C8B	7C8C	7C8D	7C8E	7C8F	7C90	7C91	7C92	7C93	7C94	7C95	7C96	7C97	7C98
	Char.	綰	綰	綰	綰	綰	綰	綰	綰	綰	綰	綰	綰	綰	綰	綰	綰
E070	IBM	7C99	7C9A	7C9B	7C9C	7C9D	7C9E	7C9F	7CA0	7CA1	7CA2	7CA3	7CA4	7CA5	7CA6	7CA7	
	Char.	綰	綰	綰	綰	綰	綰	綰	綰	綰	綰	綰	綰	綰	綰	綰	

Table B-4 Big5 à IBM Conversion Table (continued)

Big5		+ 0	+ 1	+ 2	+ 3	+ 4	+ 5	+ 6	+ 7	+ 8	+ 9	+ A	+ B	+ C	+ D	+ E	+ F
E0A0	IBM		7CA8	7CA9	7CAA	7CAB	7CAC	7CAD	7CAE	7CAF	7CB0	7CB1	7CB2	7CB3	7CB4	7CB5	7CB6
	Char.		邁	邁	邁	鄺	鄺	鄺	鄺	鄺	鄺	鄺	鄺	鄺	鄺	鄺	鄺
E0B0	IBM	7CB7	7CB8	7CB9	7CBA	7CBB	7CBC	7CBD	7CBE	7CBF	7CC0	7CC1	7CC2	7CC3	7CC4	7CC5	7CC6
	Char.	鈺	鈺	鈺	鈺	鈺	鈺	鈺	鈺	鈺	鈺	鈺	鈺	鈺	鈺	鈺	鈺
E0C0	IBM	7CC7	7CC8	7CC9	7CCA	7CCB	7CCC	7CCD	7CCE	7CCF	7CD0	7CD1	7CD2	7CD3	7CD4	7CD5	7CD6
	Char.	鈺	鈺	鈺	鈺	鈺	鈺	鈺	鈺	鈺	鈺	鈺	鈺	鈺	鈺	鈺	鈺
E0D0	IBM	7CD7	7CD8	7CD9	7CDA	7CDB	7CDC	7CDD	7CDE	7CDF	7CE0	7CE1	7CE2	7CE3	7CE4	7CE5	7CE6
	Char.	閏	賺	墜	墜	隗	隗	隗	隗	隗	隗	隗	隗	隗	隗	隗	隗
E0E0	IBM	7CE7	7CE8	7CE9	7CEA	7CEB	7CEC	7CED	7CEE	7CEF	7CF0	7CF1	7CF2	7CF3	7CF4	7CF5	7CF6
	Char.	頤	颯	颯	颯	颯	颯	颯	颯	颯	颯	颯	颯	颯	颯	颯	颯
E0F0	IBM	7CF7	7CF8	7CF9	7CFA	7CFB	7CFC	7CFD	7D41	7D42	7D43	7D44	7D45	7D46	7D47	7D48	
	Char.	儻	儻	儻	儻	儻	儻	儻	儻	儻	儻	儻	儻	儻	儻	儻	
E140	IBM	7D49	7D4A	7D4B	7D4C	7D4D	7D4E	7D4F	7D50	7D51	7D52	7D53	7D54	7D55	7D56	7D57	7D58
	Char.	漸	漸	漸	漸	漸	漸	漸	漸	漸	漸	漸	漸	漸	漸	漸	漸
E150	IBM	7D59	7D5A	7D5B	7D5C	7D5D	7D5E	7D5F	7D60	7D61	7D62	7D63	7D64	7D65	7D66	7D67	7D68
	Char.	階	唯	嘍	嘍	嘍	嘍	嘍	嘍	嘍	嘍	嘍	嘍	嘍	嘍	嘍	嘍
E160	IBM	7D69	7D6A	7D6B	7D6C	7D6D	7D6E	7D6F	7D70	7D71	7D72	7D73	7D74	7D75	7D76	7D77	7D78
	Char.	璋	璋	璋	璋	璋	璋	璋	璋	璋	璋	璋	璋	璋	璋	璋	璋
E170	IBM	7D79	7D7A	7D7B	7D7C	7D7D	7D7E	7D7F	7D81	7D82	7D83	7D84	7D85	7D86	7D87	7D88	
	Char.	嫵	嫵	嫵	嫵	嫵	嫵	嫵	嫵	嫵	嫵	嫵	嫵	嫵	嫵		
E1A0	IBM		7D89	7D8A	7D8B	7D8C	7D8D	7D8E	7D8F	7D90	7D91	7D92	7D93	7D94	7D95	7D96	7D97
	Char.		瘡	瘡	瘡	瘡	瘡	瘡	瘡	瘡	瘡	瘡	瘡	瘡	瘡	瘡	瘡
E1B0	IBM	7D98	7D99	7D9A	7D9B	7D9C	7D9D	7D9E	7D9F	7DA0	7DA1	7DA2	7DA3	7DA4	7DA5	7DA6	7DA7
	Char.	強	嶺	嶺	嶺	嶺	嶺	嶺	嶺	嶺	嶺	嶺	嶺	嶺	嶺	嶺	嶺

Table B-4 Big5 à IBM Conversion Table (continued)

Big5		+ 0	+ 1	+ 2	+ 3	+ 4	+ 5	+ 6	+ 7	+ 8	+ 9	+ A	+ B	+ C	+ D	+ E	+ F
E1C0	IBM	7DA8	7DA9	7DAA	7DAB	7DAC	7DAD	7DAE	7DAF	7DB0	7DB1	7DB2	7DB3	7DB4	7DB5	7DB6	7DB7
	Char.	影	徹	愨	愨	恩	悼	博	慳	惜	標	惱	懂	慘	惱	模	樓
E1D0	IBM	7DB8	7DB9	7DBA	7DBB	7DBC	7DBD	7DBE	7DBF	7DC0	7DC1	7DC2	7DC3	7DC4	7DC5	7DC6	7DC7
	Char.	催	髓	愁	樞	俠	憫	戩	戩	鹹	擊	縮	搞	搥	擣	擣	擣
E1E0	IBM	7DC8	7DC9	7DCA	7DCB	7DCC	7DCD	7DCE	7DCF	7DD0	7DD1	7DD2	7DD3	7DD4	7DD5	7DD6	7DD7
	Char.	樞	標	搥	擣	擣	擣	擣	擣	擣	擣	擣	擣	擣	擣	擣	擣
E1F0	IBM	7DD8	7DD9	7DDA	7ddb	7DDC	7DDD	7DDE	7DDF	7DE0	7DE1	7DE2	7DE3	7DE4	7DE5	7DE6	
	Char.	規	擣	擣	擣	擣	擣	擣	擣	擣	擣	擣	擣	擣	擣	擣	
E240	IBM	7DE7	7DE8	7DE9	7DEA	7DEB	7DEC	7DED	7DEE	7DEF	7DF0	7DF1	7DF2	7DF3	7DF4	7DF5	7DF6
	Char.	榎	榎	榎	榎	榎	榎	榎	榎	榎	榎	榎	榎	榎	榎	榎	榎
E250	IBM	7DF7	7DF8	7DF9	7DFA	7DFB	7DFC	7DFD	7E41	7E42	7E43	7E44	7E45	7E46	7E47	7E48	7E49
	Char.	榎	榎	榎	榎	榎	榎	榎	榎	榎	榎	榎	榎	榎	榎	榎	榎
E260	IBM	7E4A	7E4B	7E4C	7E4D	7E4E	7E4F	7E50	7E51	7E52	7E53	7E54	7E55	7E56	7E57	7E58	7E59
	Char.	榎	榎	榎	榎	榎	榎	榎	榎	榎	榎	榎	榎	榎	榎	榎	榎
E270	IBM	7E5A	7E5B	7E5C	7E5D	7E5E	7E5F	7E60	7E61	7E62	7E63	7E64	7E65	7E66	7E67	7E68	
	Char.	漚	漚	漚	漚	漚	漚	漚	漚	漚	漚	漚	漚	漚	漚	漚	
E2A0	IBM		7E69	7E6A	7E6B	7E6C	7E6D	7E6E	7E6F	7E70	7E71	7E72	7E73	7E74	7E75	7E76	7E77
	Char.		漚	漚	漚	漚	漚	漚	漚	漚	漚	漚	漚	漚	漚	漚	漚
E2B0	IBM	7E78	7E79	7E7A	7E7B	7E7C	7E7D	7E7E	7E7F	7E81	7E82	7E83	7E84	7E85	7E86	7E87	7E88
	Char.	漚	漚	漚	漚	漚	漚	漚	漚	漚	漚	漚	漚	漚	漚	漚	漚
E2C0	IBM	7E89	7E8A	7E8B	7E8C	7E8D	7E8E	7E8F	7E90	7E91	7E92	7E93	7E94	7E95	7E96	7E97	7E98
	Char.	漚	漚	漚	漚	漚	漚	漚	漚	漚	漚	漚	漚	漚	漚	漚	漚
E2D0	IBM	7E99	7E9A	7E9B	7E9C	7E9D	7E9E	7E9F	7EA0	7EA1	7EA2	7EA3	7EA4	7EA5	7EA6	7EA7	7EA8
	Char.	漚	漚	漚	漚	漚	漚	漚	漚	漚	漚	漚	漚	漚	漚	漚	漚

Table B-4 Big5 à IBM Conversion Table (continued)

Big5		+ 0	+ 1	+ 2	+ 3	+ 4	+ 5	+ 6	+ 7	+ 8	+ 9	+ A	+ B	+ C	+ D	+ E	+ F
E2E0	IBM	7EA9	7EAA	7EAB	7EAC	7EAD	7EAE	7EAF	7EB0	7EB1	7EB2	7EB3	7EB4	7EB5	7EB6	7EB7	7EB8
	Char.	痞	駮	瞋	瞋	睺	睺	睺	睺	睺	睺	睺	睺	睺	睺	睺	睺
E2F0	IBM	7EB9	7EBA	7EBB	7EBC	7EBD	7EBE	7EBF	7EC0	7EC1	7EC2	7EC3	7EC4	7EC5	7EC6	7EC7	
	Char.	碓	碓	碓	碓	碓	碓	碓	碓	碓	碓	碓	碓	碓	碓	碓	
E340	IBM	7EC8	7EC9	7ECA	7ECB	7ECC	7ECD	7ECE	7ECF	7ED0	7ED1	7ED2	7ED3	7ED4	7ED5	7ED6	7ED7
	Char.	襪	襪	襪	襪	襪	襪	襪	襪	襪	襪	襪	襪	襪	襪	襪	
E350	IBM	7ED8	7ED9	7EDA	7EDB	7EDC	7EDD	7EDE	7EDF	7EE0	7EE1	7EE2	7EE3	7EE4	7EE5	7EE6	7EE7
	Char.	筭	筭	筭	筭	筭	筭	筭	筭	筭	筭	筭	筭	筭	筭	筭	
E360	IBM	7EE8	7EE9	7EEA	7EEB	7EEC	7EED	7EEE	7EEF	7EF0	7EF1	7EF2	7EF3	7EF4	7EF5	7EF6	7EF7
	Char.	縲	縲	縲	縲	縲	縲	縲	縲	縲	縲	縲	縲	縲	縲	縲	
E370	IBM	7EF8	7EF9	7EFA	7EFB	7EFC	7EFD	7F41	7F42	7F43	7F44	7F45	7F46	7F47	7F48	7F49	
	Char.	縲	縲	縲	縲	縲	縲	縲	縲	縲	縲	縲	縲	縲	縲	縲	
E3A0	IBM		7F4A	7F4B	7F4C	7F4D	7F4E	7F4F	7F50	7F51	7F52	7F53	7F54	7F55	7F56	7F57	7F58
	Char.		藉	藉	藉	藉	藉	藉	藉	藉	藉	藉	藉	藉	藉	藉	
E3B0	IBM	7F59	7F5A	7F5B	7F5C	7F5D	7F5E	7F5F	7F60	7F61	7F62	7F63	7F64	7F65	7F66	7F67	7F68
	Char.	蒺	蒺	蒺	蒺	蒺	蒺	蒺	蒺	蒺	蒺	蒺	蒺	蒺	蒺	蒺	
E3C0	IBM	7F69	7F6A	7F6B	7F6C	7F6D	7F6E	7F6F	7F70	7F71	7F72	7F73	7F74	7F75	7F76	7F77	7F78
	Char.	蒺	蒺	蒺	蒺	蒺	蒺	蒺	蒺	蒺	蒺	蒺	蒺	蒺	蒺	蒺	
E3D0	IBM	7F79	7F7A	7F7B	7F7C	7F7D	7F7E	7F7F	7F81	7F82	7F83	7F84	7F85	7F86	7F87	7F88	7F89
	Char.	蒺	蒺	蒺	蒺	蒺	蒺	蒺	蒺	蒺	蒺	蒺	蒺	蒺	蒺	蒺	
E3E0	IBM	7F8A	7F8B	7F8C	7F8D	7F8E	7F8F	7F90	7F91	7F92	7F93	7F94	7F95	7F96	7F97	7F98	7F99
	Char.	蒺	蒺	蒺	蒺	蒺	蒺	蒺	蒺	蒺	蒺	蒺	蒺	蒺	蒺	蒺	

Table B-4 Big5 à IBM Conversion Table (continued)

Big5		+ 0	+ 1	+ 2	+ 3	+ 4	+ 5	+ 6	+ 7	+ 8	+ 9	+ A	+ B	+ C	+ D	+ E	+ F
E3F0	IBM	7F9A	7F9B	7F9C	7F9D	7F9E	7F9F	7FA0	7FA1	7FA2	7FA3	7FA4	7FA5	7FA6	7FA7	7FA8	
	Char.	蟹	蜃	蜚	蟹	襪	襪	襪	襪	襪	襪	襪	襪	襪	襪	襪	
E440	IBM	7FA9	7FAA	7FAB	7FAC	7FAD	7FAE	7FAF	7FB0	7FB1	7FB2	7FB3	7FB4	7FB5	7FB6	7FB7	7FB8
	Char.	襪	襪	襪	襪	襪	襪	襪	襪	襪	襪	襪	襪	襪	襪	襪	襪
E450	IBM	7FB9	7FBA	7FBB	7FBC	7FBD	7FBE	7FBF	7FC0	7FC1	7FC2	7FC3	7FC4	7FC5	7FC6	7FC7	7FC8
	Char.	筮	豨	豨	豚	睪	睪	越	踉	跂	踈	踈	踈	踈	踈	踈	踈
E460	IBM	7FC9	7FCA	7FCB	7FCC	7FCD	7FCE	7FCF	7FD0	7FD1	7FD2	7FD3	7FD4	7FD5	7FD6	7FD7	7FD8
	Char.	羶	筮	踈	踈	鞞	鞞	鞞	鞞	鞞	鞞	鞞	鞞	鞞	鞞	鞞	鞞
E470	IBM	7FD9	7FDA	7FDB	7FDC	7FDD	7FDE	7FDF	7FE0	7FE1	7FE2	7FE3	7FE4	7FE5	7FE6	7FE7	
	Char.	鄴	鄴	酹	醒	醒	醒	鉞	鉞	鉞	鉞	鉞	鉞	鉞	鉞	鉞	
E4A0	IBM		7FE8	7FE9	7FEA	7FEB	7FEC	7FED	7FEE	7FEF	7FF0	7FF1	7FF2	7FF3	7FF4	7FF5	7FF6
	Char.		鉞	鉞	鉞	鉞	鉞	鉞	鉞	鉞	鉞	鉞	鉞	鉞	鉞	鉞	鉞
E4B0	IBM	7FF7	7FF8	7FF9	7FFA	7FFB	7FFC	7FFD	8041	8042	8043	8044	8045	8046	8047	8048	8049
	Char.	鉞	鉞	鉞	鉞	鉞	鉞	鉞	鉞	鉞	鉞	鉞	鉞	鉞	鉞	鉞	鉞
E4C0	IBM	804A	804B	804C	804D	804E	804F	8050	8051	8052	8053	8054	8055	8056	8057	8058	8059
	Char.	鞞	鞞	鞞	鞞	鞞	鞞	鞞	鞞	鞞	鞞	鞞	鞞	鞞	鞞	鞞	鞞
E4D0	IBM	805A	805B	805C	805D	805E	805F	8060	8061	8062	8063	8064	8065	8066	8067	8068	8069
	Char.	飼	秘	駝	駝	駝	駝	駝	駝	駝	駝	駝	駝	駝	駝	駝	駝
E4E0	IBM	806A	806B	806C	806D	806E	806F	8070	8071	8072	8073	8074	8075	8076	8077	8078	8079
	Char.	鈞	鈞	鴉	鴉	鴉	鸚	僿	僿	僿	僿	僿	僿	僿	僿	僿	僿
E4F0	IBM	807A	807B	807C	807D	807E	807F	8081	8082	8083	8084	8085	8086	8087	8088	8089	
	Char.	僿	僿	剝	剝	勳	勳	噉	噉	噉	噉	噉	噉	噉	噉	噉	

Table B-4 Big5 à IBM Conversion Table (continued)

Big5		+ 0	+ 1	+ 2	+ 3	+ 4	+ 5	+ 6	+ 7	+ 8	+ 9	+ A	+ B	+ C	+ D	+ E	+ F
E540	IBM	808A	808B	808C	808D	808E	808F	8090	8091	8092	8093	8094	8095	8096	8097	8098	8099
	Char.	噤	噤	噤	噤	噤	噤	噤	噤	噤	噤	噤	噤	噤	噤	噤	噤
E550	IBM	809A	809B	809C	809D	809E	809F	80A0	80A1	80A2	80A3	80A4	80A5	80A6	80A7	80A8	80A9
	Char.	墜	墜	墜	墜	墜	墜	墜	墜	墜	墜	墜	墜	墜	墜	墜	墜
E560	IBM	80AA	80AB	80AC	80AD	80AE	80AF	80B0	80B1	80B2	80B3	80B4	80B5	80B6	80B7	80B8	80B9
	Char.	嬭	嬭	嬭	嬭	嬭	嬭	嬭	嬭	嬭	嬭	嬭	嬭	嬭	嬭	嬭	嬭
E570	IBM	80BA	80BB	80BC	80BD	80BE	80BF	80C0	80C1	80C2	80C3	80C4	80C5	80C6	80C7	80C8	
	Char.	撫	撫	撫	撫	撫	撫	撫	撫	撫	撫	撫	撫	撫	撫	撫	
E5A0	IBM		80C9	80CA	80CB	80CC	80CD	80CE	80CF	80D0	80D1	80D2	80D3	80D4	80D5	80D6	80D7
	Char.		憚	憚	憚	憚	憚	憚	憚	憚	憚	憚	憚	憚	憚	憚	憚
E5B0	IBM	80D8	80D9	80DA	80DB	80DC	80DD	80DE	80DF	80E0	80E1	80E2	80E3	80E4	80E5	80E6	80E7
	Char.	擻	擻	擻	擻	擻	擻	擻	擻	擻	擻	擻	擻	擻	擻	擻	擻
E5C0	IBM	80E8	80E9	80EA	80EB	80EC	80ED	80EE	80EF	80F0	80F1	80F2	80F3	80F4	80F5	80F6	80F7
	Char.	覓	覓	覓	覓	覓	覓	覓	覓	覓	覓	覓	覓	覓	覓	覓	覓
E5D0	IBM	80F8	80F9	80FA	80FB	80FC	80FD	8141	8142	8143	8144	8145	8146	8147	8148	8149	814A
	Char.	標	標	標	標	標	標	標	標	標	標	標	標	標	標	標	標
E5E0	IBM	814B	814C	814D	814E	814F	8150	8151	8152	8153	8154	8155	8156	8157	8158	8159	815A
	Char.	椀	椀	椀	椀	椀	椀	椀	椀	椀	椀	椀	椀	椀	椀	椀	椀
E5F0	IBM	815B	815C	815D	815E	815F	8160	8161	8162	8163	8164	8165	8166	8167	8168	8169	
	Char.	歛	歛	歛	歛	歛	歛	歛	歛	歛	歛	歛	歛	歛	歛	歛	
E640	IBM	816A	816B	816C	816D	816E	816F	8170	8171	8172	8173	8174	8175	8176	8177	8178	8179
	Char.	澗	澗	澗	澗	澗	澗	澗	澗	澗	澗	澗	澗	澗	澗	澗	澗
E650	IBM	817A	817B	817C	817D	817E	817F	8181	8182	8183	8184	8185	8186	8187	8188	8189	818A
	Char.	澗	澗	澗	澗	澗	澗	澗	澗	澗	澗	澗	澗	澗	澗	澗	澗

Table B-4 Big5 à IBM Conversion Table (continued)

Big5		+ 0	+ 1	+ 2	+ 3	+ 4	+ 5	+ 6	+ 7	+ 8	+ 9	+ A	+ B	+ C	+ D	+ E	+ F
E660	IBM	818B	818C	818D	818E	818F	8190	8191	8192	8193	8194	8195	8196	8197	8198	8199	819A
	Char.	潛	漆	頰	爨	標	焜	熠	燁	焜	熾	焜	燻	燻	燻	燻	燻
E670	IBM	819B	819C	819D	819E	819F	81A0	81A1	81A2	81A3	81A4	81A5	81A6	81A7	81A8	81A9	
	Char.	燻	燻	燻	摩	摩	獎	獎	獾	獾	獾	獾	獾	獾	獾	獾	
E6A0	IBM		81AA	81AB	81AC	81AD	81AE	81AF	81B0	81B1	81B2	81B3	81B4	81B5	81B6	81B7	81B8
	Char.		獾	璇	璉	璉	璉	璉	璉	璉	璉	璉	璉	璉	璉	璉	瘥
E6B0	IBM	81B9	81BA	81BB	81BC	81BD	81BE	81BF	81C0	81C1	81C2	81C3	81C4	81C5	81C6	81C7	81C8
	Char.	瘥	瘥	瘥	瘥	瘥	瘥	瘥	瘥	瘥	瘥	瘥	瘥	瘥	瘥	瘥	瘥
E6C0	IBM	81C9	81CA	81CB	81CC	81CD	81CE	81CF	81D0	81D1	81D2	81D3	81D4	81D5	81D6	81D7	81D8
	Char.	磻	磻	磻	磻	磻	磻	磻	磻	磻	磻	磻	磻	磻	磻	磻	磻
E6D0	IBM	81D9	81DA	81DB	81DC	81DD	81DE	81DF	81E0	81E1	81E2	81E3	81E4	81E5	81E6	81E7	81E8
	Char.	禎	鶯	稭	竊	竊	竊	竊	箭	箭	箭	箭	箭	箭	箭	箭	糅
E6E0	IBM	81E9	81EA	81EB	81EC	81ED	81EE	81EF	81F0	81F1	81F2	81F3	81F4	81F5	81F6	81F7	81F8
	Char.	糅	糅	糅	糅	糅	糅	糅	糅	糅	糅	糅	糅	糅	糅	糅	糅
E6F0	IBM	81F9	81FA	81FB	81FC	81FD	8241	8242	8243	8244	8245	8246	8247	8248	8249	824A	
	Char.	鍾	留	臧	羴	羴	羴	羴	羴	羴	羴	羴	羴	羴	羴	羴	
E740	IBM	824B	824C	824D	824E	824F	8250	8251	8252	8253	8254	8255	8256	8257	8258	8259	825A
	Char.	膊	膾	膾	膾	膾	舖	膾	膾	膾	膾	膾	膾	膾	膾	膾	膾
E750	IBM	825B	825C	825D	825E	825F	8260	8261	8262	8263	8264	8265	8266	8267	8268	8269	826A
	Char.	黃	葭	葭	葭	葭	葭	葭	葭	葭	葭	葭	葭	葭	葭	葭	葭
E760	IBM	826B	826C	826D	826E	826F	8270	8271	8272	8273	8274	8275	8276	8277	8278	8279	827A
	Char.	蒂	葭	葭	葭	葭	葭	葭	葭	葭	葭	葭	葭	葭	葭	葭	葭
E770	IBM	827B	827C	827D	827E	827F	8281	8282	8283	8284	8285	8286	8287	8288	8289	828A	
	Char.	確	葭	葭	葭	葭	葭	葭	葭	葭	葭	葭	葭	葭	葭	葭	

Table B-4 Big5 à IBM Conversion Table (continued)

Big5		+ 0	+ 1	+ 2	+ 3	+ 4	+ 5	+ 6	+ 7	+ 8	+ 9	+ A	+ B	+ C	+ D	+ E	+ F
E7A0	IBM		828B	828C	828D	828E	828F	8290	8291	8292	8293	8294	8295	8296	8297	8298	8299
	Char.		蝗	螞	蟪	蟬	螞	蟻	蟻	蟻	蟻	蟻	蟻	蟻	蟻	蟻	蟻
E7B0	IBM	829A	829B	829C	829D	829E	829F	82A0	82A1	82A2	82A3	82A4	82A5	82A6	82A7	82A8	82A9
	Char.	蟻	蟻	蟻	蟻	蟻	蟻	蟻	蟻	蟻	蟻	蟻	蟻	蟻	蟻	蟻	蟻
E7C0	IBM	82AA	82AB	82AC	82AD	82AE	82AF	82B0	82B1	82B2	82B3	82B4	82B5	82B6	82B7	82B8	82B9
	Char.	蟻	蟻	蟻	蟻	蟻	蟻	蟻	蟻	蟻	蟻	蟻	蟻	蟻	蟻	蟻	蟻
E7D0	IBM	82BA	82BB	82BC	82BD	82BE	82BF	82C0	82C1	82C2	82C3	82C4	82C5	82C6	82C7	82C8	82C9
	Char.	覬	覬	覬	覬	覬	覬	覬	覬	覬	覬	覬	覬	覬	覬	覬	覬
E7E0	IBM	82CA	82CB	82CC	82CD	82CE	82CF	82D0	82D1	82D2	82D3	82D4	82D5	82D6	82D7	82D8	82D9
	Char.	覬	覬	覬	覬	覬	覬	覬	覬	覬	覬	覬	覬	覬	覬	覬	覬
E7F0	IBM	82DA	82DB	82DC	82DD	82DE	82DF	82E0	82E1	82E2	82E3	82E4	82E5	82E6	82E7	82E8	
	Char.	覬	覬	覬	覬	覬	覬	覬	覬	覬	覬	覬	覬	覬	覬	覬	
E840	IBM	82E9	82EA	82EB	82EC	82ED	82EE	82EF	82F0	82F1	82F2	82F3	82F4	82F5	82F6	82F7	82F8
	Char.	覬	覬	覬	覬	覬	覬	覬	覬	覬	覬	覬	覬	覬	覬	覬	覬
E850	IBM	82F9	82FA	82FB	82FC	82FD	8341	8342	8343	8344	8345	8346	8347	8348	8349	834A	834B
	Char.	覬	覬	覬	覬	覬	覬	覬	覬	覬	覬	覬	覬	覬	覬	覬	覬
E860	IBM	834C	834D	834E	834F	8350	8351	8352	8353	8354	8355	8356	8357	8358	8359	835A	835B
	Char.	覬	覬	覬	覬	覬	覬	覬	覬	覬	覬	覬	覬	覬	覬	覬	覬
E870	IBM	835C	835D	835E	835F	8360	8361	8362	8363	8364	8365	8366	8367	8368	8369	836A	
	Char.	覬	覬	覬	覬	覬	覬	覬	覬	覬	覬	覬	覬	覬	覬	覬	
E8A0	IBM		836B	836C	836D	836E	836F	8370	8371	8372	8373	8374	8375	8376	8377	8378	8379
	Char.		覬	覬	覬	覬	覬	覬	覬	覬	覬	覬	覬	覬	覬	覬	覬
E8B0	IBM	837A	837B	837C	837D	837E	837F	8381	8382	8383	8384	8385	8386	8387	8388	8389	838A
	Char.	覬	覬	覬	覬	覬	覬	覬	覬	覬	覬	覬	覬	覬	覬	覬	覬

Table B-4 Big5 à IBM Conversion Table (continued)

Big5		+ 0	+ 1	+ 2	+ 3	+ 4	+ 5	+ 6	+ 7	+ 8	+ 9	+ A	+ B	+ C	+ D	+ E	+ F
E8C0	IBM	838B	838C	838D	838E	838F	8390	8391	8392	8393	8394	8395	8396	8397	8398	8399	839A
	Char.	饗	饗	舖	餛	餛	餛	駢	駢	駢	駢	駢	駢	駢	駢	駢	駢
E8D0	IBM	839B	839C	839D	839E	839F	83A0	83A1	83A2	83A3	83A4	83A5	83A6	83A7	83A8	83A9	83AA
	Char.	駢	駢	駢	駢	駢	駢	駢	駢	駢	駢	駢	駢	駢	駢	駢	駢
E8E0	IBM	83AB	83AC	83AD	83AE	83AF	83B0	83B1	83B2	83B3	83B4	83B5	83B6	83B7	83B8	83B9	83BA
	Char.	駢	駢	駢	駢	駢	駢	駢	駢	駢	駢	駢	駢	駢	駢	駢	駢
E8F0	IBM	83BB	83BC	83BD	83BE	83BF	83C0	83C1	83C2	83C3	83C4	83C5	83C6	83C7	83C8	83C9	
	Char.	駢	駢	駢	駢	駢	駢	駢	駢	駢	駢	駢	駢	駢	駢	駢	
E940	IBM	83CA	83CB	83CC	83CD	83CE	83CF	83D0	83D1	83D2	83D3	83D4	83D5	83D6	83D7	83D8	83D9
	Char.	駢	駢	駢	駢	駢	駢	駢	駢	駢	駢	駢	駢	駢	駢	駢	駢
E950	IBM	83DA	83DB	83DC	83DD	83DE	83DF	83E0	83E1	83E2	83E3	83E4	83E5	83E6	83E7	83E8	83E9
	Char.	駢	駢	駢	駢	駢	駢	駢	駢	駢	駢	駢	駢	駢	駢	駢	駢
E960	IBM	83EA	83EB	83EC	83ED	83EE	83EF	83F0	83F1	83F2	83F3	83F4	83F5	83F6	83F7	83F8	83F9
	Char.	駢	駢	駢	駢	駢	駢	駢	駢	駢	駢	駢	駢	駢	駢	駢	駢
E970	IBM	83FA	83FB	83FC	83FD	8441	8442	8443	8444	8445	8446	8447	8448	8449	844A	844B	
	Char.	駢	駢	駢	駢	駢	駢	駢	駢	駢	駢	駢	駢	駢	駢	駢	
E9A0	IBM		844C	844D	844E	844F	8450	8451	8452	8453	8454	8455	8456	8457	8458	8459	845A
	Char.		駢	駢	駢	駢	駢	駢	駢	駢	駢	駢	駢	駢	駢	駢	駢
E9B0	IBM	845B	845C	845D	845E	845F	8460	8461	8462	8463	8464	8465	8466	8467	8468	8469	846A
	Char.	駢	駢	駢	駢	駢	駢	駢	駢	駢	駢	駢	駢	駢	駢	駢	駢
E9C0	IBM	846B	846C	846D	846E	846F	8470	8471	8472	8473	8474	8475	8476	8477	8478	8479	847A
	Char.	駢	駢	駢	駢	駢	駢	駢	駢	駢	駢	駢	駢	駢	駢	駢	駢
E9D0	IBM	847B	847C	847D	847E	847F	8481	8482	8483	8484	8485	8486	8487	8488	8489	848A	848B
	Char.	駢	駢	駢	駢	駢	駢	駢	駢	駢	駢	駢	駢	駢	駢	駢	駢

Table B-4 Big5 à IBM Conversion Table (continued)

Big5		+ 0	+ 1	+ 2	+ 3	+ 4	+ 5	+ 6	+ 7	+ 8	+ 9	+ A	+ B	+ C	+ D	+ E	+ F
E9E0	IBM	848C	848D	848E	848F	8490	8491	8492	8493	8494	8495	8496	8497	8498	8499	849A	849B
	Char.	歡	歛	瘡	彈	毆	毆	駝	氈	氈	漣	漣	澗	澗	澗	澗	澗
E9F0	IBM	849C	849D	849E	849F	84A0	84A1	84A2	84A3	84A4	84A5	84A6	84A7	84A8	84A9	84AA	
	Char.	潞	澗	澗	澗	澗	澗	澗	澗	澗	澗	澗	澗	澗	澗	澗	
EA40	IBM	84AB	84AC	84AD	84AE	84AF	84B0	84B1	84B2	84B3	84B4	84B5	84B6	84B7	84B8	84B9	84BA
	Char.	澗	澗	澗	澗	澗	澗	澗	澗	澗	澗	澗	澗	澗	澗	澗	澗
EA50	IBM	84BB	84BC	84BD	84BE	84BF	84C0	84C1	84C2	84C3	84C4	84C5	84C6	84C7	84C8	84C9	84CA
	Char.	桑	燭	燭	燭	燭	燭	燭	燭	燭	燭	燭	燭	燭	燭	燭	燭
EA60	IBM	84CB	84CC	84CD	84CE	84CF	84D0	84D1	84D2	84D3	84D4	84D5	84D6	84D7	84D8	84D9	84DA
	Char.	獫	獫	獫	獫	獫	獫	獫	獫	獫	獫	獫	獫	獫	獫	獫	獫
EA70	IBM	84DB	84DC	84DD	84DE	84DF	84E0	84E1	84E2	84E3	84E4	84E5	84E6	84E7	84E8	84E9	
	Char.	瘡	瘡	瘡	瘡	瘡	瘡	瘡	瘡	瘡	瘡	瘡	瘡	瘡	瘡	瘡	
EAA0	IBM		84EA	84EB	84EC	84ED	84EE	84EF	84F0	84F1	84F2	84F3	84F4	84F5	84F6	84F7	84F8
	Char.		鳴	礮	礮	礮	礮	礮	礮	礮	礮	礮	礮	礮	礮	礮	礮
EAB0	IBM	84F9	84FA	84FB	84FC	84FD	8541	8542	8543	8544	8545	8546	8547	8548	8549	854A	854B
	Char.	糜	穆	窶	窶	窶	窶	窶	窶	窶	窶	窶	窶	窶	窶	窶	窶
EAC0	IBM	854C	854D	854E	854F	8550	8551	8552	8553	8554	8555	8556	8557	8558	8559	855A	855B
	Char.	箕	簾	箕	簾	簾	簾	簾	簾	簾	簾	簾	簾	簾	簾	簾	簾
EAD0	IBM	855C	855D	855E	855F	8560	8561	8562	8563	8564	8565	8566	8567	8568	8569	856A	856B
	Char.	縹	縹	縹	縹	縹	縹	縹	縹	縹	縹	縹	縹	縹	縹	縹	縹
EAE0	IBM	856C	856D	856E	856F	8570	8571	8572	8573	8574	8575	8576	8577	8578	8579	857A	857B
	Char.	尉	畢	翼	翹	翹	翹	翹	翹	翹	翹	翹	翹	翹	翹	翹	翹
EAF0	IBM	857C	857D	857E	857F	8581	8582	8583	8584	8585	8586	8587	8588	8589	858A	858B	
	Char.	臚	臚	腳	臚	臚	臚	臚	臚	臚	臚	臚	臚	臚	臚	臚	

Table B-4 Big5 à IBM Conversion Table (continued)

Big5		+ 0	+ 1	+ 2	+ 3	+ 4	+ 5	+ 6	+ 7	+ 8	+ 9	+ A	+ B	+ C	+ D	+ E	+ F
EB40	IBM	858C	858D	858E	858F	8590	8591	8592	8593	8594	8595	8596	8597	8598	8599	859A	859B
	Char.	蕨	葳	蕤	蕞	蕨	蔞	蔠	蔡	蔢	蔣	蔣	蔣	蔣	蔣	蔣	蔣
EB50	IBM	859C	859D	859E	859F	85A0	85A1	85A2	85A3	85A4	85A5	85A6	85A7	85A8	85A9	85AA	85AB
	Char.	蕨	蕤	蕞	蕟	蕟	蕟	蕟	蕟	蕟	蕟	蕟	蕟	蕟	蕟	蕟	蕟
EB60	IBM	85AC	85AD	85AE	85AF	85B0	85B1	85B2	85B3	85B4	85B5	85B6	85B7	85B8	85B9	85BA	85BB
	Char.	蠟	蠟	蠟	蠟	蠟	蠟	蠟	蠟	蠟	蠟	蠟	蠟	蠟	蠟	蠟	蠟
EB70	IBM	85BC	85BD	85BE	85BF	85C0	85C1	85C2	85C3	85C4	85C5	85C6	85C7	85C8	85C9	85CA	
	Char.	襪	襪	襪	襪	襪	襪	襪	襪	襪	襪	襪	襪	襪	襪	襪	
EBA0	IBM		85CB	85CC	85CD	85CE	85CF	85D0	85D1	85D2	85D3	85D4	85D5	85D6	85D7	85D8	85D9
	Char.		諱	諱	諱	諱	諱	諱	諱	諱	諱	諱	諱	諱	諱	諱	諱
EBB0	IBM	85DA	85DB	85DC	85DD	85DE	85DF	85E0	85E1	85E2	85E3	85E4	85E5	85E6	85E7	85E8	85E9
	Char.	諱	諱	諱	諱	諱	諱	諱	諱	諱	諱	諱	諱	諱	諱	諱	諱
EBC0	IBM	85EA	85EB	85EC	85ED	85EE	85EF	85F0	85F1	85F2	85F3	85F4	85F5	85F6	85F7	85F8	85F9
	Char.	蹠	蹠	蹠	蹠	蹠	蹠	蹠	蹠	蹠	蹠	蹠	蹠	蹠	蹠	蹠	蹠
EBD0	IBM	85FA	85FB	85FC	85FD	8641	8642	8643	8644	8645	8646	8647	8648	8649	864A	864B	864C
	Char.	遶	遶	遶	遶	遶	遶	遶	遶	遶	遶	遶	遶	遶	遶	遶	遶
EBE0	IBM	864D	864E	864F	8650	8651	8652	8653	8654	8655	8656	8657	8658	8659	865A	865B	865C
	Char.	鈹	鈹	鈹	鈹	鈹	鈹	鈹	鈹	鈹	鈹	鈹	鈹	鈹	鈹	鈹	鈹
EBF0	IBM	865D	865E	865F	8660	8661	8662	8663	8664	8665	8666	8667	8668	8669	866A	866B	
	Char.	銻	銻	銻	銻	銻	銻	銻	銻	銻	銻	銻	銻	銻	銻	銻	
EC40	IBM	866C	866D	866E	866F	8670	8671	8672	8673	8674	8675	8676	8677	8678	8679	867A	867B
	Char.	鏹	鏹	鏹	鏹	鏹	鏹	鏹	鏹	鏹	鏹	鏹	鏹	鏹	鏹	鏹	鏹

Table B-4 Big5 à IBM Conversion Table (continued)

Big5		+ 0	+ 1	+ 2	+ 3	+ 4	+ 5	+ 6	+ 7	+ 8	+ 9	+ A	+ B	+ C	+ D	+ E	+ F
EC50	IBM	867C	867D	867E	867F	8681	8682	8683	8684	8685	8686	8687	8688	8689	868A	868B	868C
	Char.	雒	雒	齡	靈	鞞	倥	鞞	鞞	鞞	鞞	頰	頰	頰	頰	餗	餗
EC60	IBM	868D	868E	868F	8690	8691	8692	8693	8694	8695	8696	8697	8698	8699	869A	869B	869C
	Char.	醇	駁	駁	駁	駁	駁	駁	駁	駁	駁	駁	駁	駁	駁	駁	駁
EC70	IBM	869D	869E	869F	86A0	86A1	86A2	86A3	86A4	86A5	86A6	86A7	86A8	86A9	86AA	86AB	
	Char.	樛	樛	虞	鮫	鮫	鮫	鮫	鮫	鮫	鮫	鮫	鮫	鮫	鮫	鮫	
ECA0	IBM		86AC	86AD	86AE	86AF	86B0	86B1	86B2	86B3	86B4	86B5	86B6	86B7	86B8	86B9	86BA
	Char.		鮒	鮒	鮒	鳩	鳩	鳩	鳩	鳩	鳩	鳩	鳩	鳩	鳩	鳩	塵
ECB0	IBM	86BB	86BC	86BD	86BE	86BF	86C0	86C1	86C2	86C3	86C4	86C5	86C6	86C7	86C8	86C9	86CA
	Char.	脛	麤	麤	麤	麤	麤	麤	麤	麤	麤	儼	儼	儼	儼	儼	勳
ECC0	IBM	86CB	86CC	86CD	86CE	86CF	86D0	86D1	86D2	86D3	86D4	86D5	86D6	86D7	86D8	86D9	86DA
	Char.	噤	噤	噤	噤	噤	噤	噤	噤	噤	噤	噤	噤	噤	噤	噤	噤
ECD0	IBM	86DB	86DC	86DD	86DE	86DF	86E0	86E1	86E2	86E3	86E4	86E5	86E6	86E7	86E8	86E9	86EA
	Char.	嬖	嬖	嬖	嬖	嬖	嬖	嬖	嬖	嬖	嬖	嬖	嬖	嬖	嬖	嬖	勳
ECE0	IBM	86EB	86EC	86ED	86EE	86EF	86F0	86F1	86F2	86F3	86F4	86F5	86F6	86F7	86F8	86F9	86FA
	Char.	愍	愍	愍	愍	愍	愍	愍	愍	愍	愍	愍	愍	愍	愍	愍	愍
ECF0	IBM	86FB	86FC	86FD	8741	8742	8743	8744	8745	8746	8747	8748	8749	874A	874B	874C	
	Char.	觸	觸	觸	觸	觸	觸	觸	觸	觸	觸	觸	觸	觸	觸	觸	
ED40	IBM	874D	874E	874F	8750	8751	8752	8753	8754	8755	8756	8757	8758	8759	875A	875B	875C
	Char.	繫	繫	繫	繫	繫	繫	繫	繫	繫	繫	繫	繫	繫	繫	繫	繫
ED50	IBM	875D	875E	875F	8760	8761	8762	8763	8764	8765	8766	8767	8768	8769	876A	876B	876C
	Char.	滌	滌	滌	滌	滌	滌	滌	滌	滌	滌	滌	滌	滌	滌	滌	滌
ED60	IBM	876D	876E	876F	8770	8771	8772	8773	8774	8775	8776	8777	8778	8779	877A	877B	877C
	Char.	熯	熯	熯	熯	熯	熯	熯	熯	熯	熯	熯	熯	熯	熯	熯	熯

Table B-4 Big5 à IBM Conversion Table (continued)

Big5		+ 0	+ 1	+ 2	+ 3	+ 4	+ 5	+ 6	+ 7	+ 8	+ 9	+ A	+ B	+ C	+ D	+ E	+ F
ED70	IBM	877D	877E	877F	8781	8782	8783	8784	8785	8786	8787	8788	8789	878A	878B	878C	
	Char.	甌	甌	甌	甌	癩	癩	癩	癩	癩	癩	癩	癩	癩	癩	癩	癩
EDA0	IBM		878D	878E	878F	8790	8791	8792	8793	8794	8795	8796	8797	8798	8799	879A	879B
	Char.		瞞	瞞	瞞	瞞	瞞	瞞	瞞	瞞	瞞	瞞	瞞	瞞	瞞	瞞	瞞
EDB0	IBM	879C	879D	879E	879F	87A0	87A1	87A2	87A3	87A4	87A5	87A6	87A7	87A8	87A9	87AA	87AB
	Char.	襪	襪	襪	襪	襪	襪	襪	襪	襪	襪	襪	襪	襪	襪	襪	襪
EDC0	IBM	87AC	87AD	87AE	87AF	87B0	87B1	87B2	87B3	87B4	87B5	87B6	87B7	87B8	87B9	87BA	87BB
	Char.	籍	籍	籍	籍	籍	籍	籍	籍	籍	籍	籍	籍	籍	籍	籍	籍
EDD0	IBM	87BC	87BD	87BE	87BF	87C0	87C1	87C2	87C3	87C4	87C5	87C6	87C7	87C8	87C9	87CA	87CB
	Char.	縞	縞	縞	縞	縞	縞	縞	縞	縞	縞	縞	縞	縞	縞	縞	縞
EDE0	IBM	87CC	87CD	87CE	87CF	87D0	87D1	87D2	87D3	87D4	87D5	87D6	87D7	87D8	87D9	87DA	87DB
	Char.	縫	縫	縫	縫	縫	縫	縫	縫	縫	縫	縫	縫	縫	縫	縫	縫
EDF0	IBM	87DC	87DD	87DE	87DF	87E0	87E1	87E2	87E3	87E4	87E5	87E6	87E7	87E8	87E9	87EA	
	Char.	艘	艘	艘	艘	艘	艘	艘	艘	艘	艘	艘	艘	艘	艘	艘	艘
EE40	IBM	87EB	87EC	87ED	87EE	87EF	87F0	87F1	87F2	87F3	87F4	87F5	87F6	87F7	87F8	87F9	87FA
	Char.	蕓	蕓	蕓	蕓	蕓	蕓	蕓	蕓	蕓	蕓	蕓	蕓	蕓	蕓	蕓	蕓
EE50	IBM	87FB	87FC	87FD	8841	8842	8843	8844	8845	8846	8847	8848	8849	884A	884B	884C	884D
	Char.	蒼	蒼	蒼	蒼	蒼	蒼	蒼	蒼	蒼	蒼	蒼	蒼	蒼	蒼	蒼	蒼
EE60	IBM	884E	884F	8850	8851	8852	8853	8854	8855	8856	8857	8858	8859	885A	885B	885C	885D
	Char.	螻	螻	螻	螻	螻	螻	螻	螻	螻	螻	螻	螻	螻	螻	螻	螻
EE70	IBM	885E	885F	8860	8861	8862	8863	8864	8865	8866	8867	8868	8869	886A	886B	886C	
	Char.	螻	螻	螻	螻	螻	螻	螻	螻	螻	螻	螻	螻	螻	螻	螻	螻
EEO0	IBM		886D	886E	886F	8870	8871	8872	8873	8874	8875	8876	8877	8878	8879	887A	887B
	Char.		諱	諱	諱	諱	諱	諱	諱	諱	諱	諱	諱	諱	諱	諱	諱

Table B-4 Big5 à IBM Conversion Table (continued)

Big5		+ 0	+ 1	+ 2	+ 3	+ 4	+ 5	+ 6	+ 7	+ 8	+ 9	+ A	+ B	+ C	+ D	+ E	+ F
EEBO	IBM	887C	887D	887E	887F	8881	8882	8883	8884	8885	8886	8887	8888	8889	888A	888B	888C
	Char.	諡	賺	穀	獠	狙	孫	獯	貌	賤	糖	躡	蹶	躡	踏	蹠	蹇
EECO	IBM	888D	888E	888F	8890	8891	8892	8893	8894	8895	8896	8897	8898	8899	889A	889B	889C
	Char.	轄	輻	遼	遼	鄴	醜	醜	醜	醜	醜	醜	醜	醜	鎡	銖	鉅
EEDO	IBM	889D	889E	889F	88A0	88A1	88A2	88A3	88A4	88A5	88A6	88A7	88A8	88A9	88AA	88AB	88AC
	Char.	錘	鎡	鎡	鎡	鎡	鎡	鎡	鎡	鎡	鎡	鎡	鎡	鎡	鎡	鎡	鎡
EEEE	IBM	88AD	88AE	88AF	88B0	88B1	88B2	88B3	88B4	88B5	88B6	88B7	88B8	88B9	88BA	88BB	88BC
	Char.	銻	鐸	錄	鐸	鐸	鐸	鐸	鐸	鐸	鐸	鐸	鐸	鐸	鐸	鐸	鐸
EEFO	IBM	88BD	88BE	88BF	88C0	88C1	88C2	88C3	88C4	88C5	88C6	88C7	88C8	88C9	88CA	88CB	
	Char.	闌	闌	闌	闌	闌	闌	闌	闌	闌	闌	闌	闌	闌	闌	闌	
EF40	IBM	88CC	88CD	88CE	88CF	88D0	88D1	88D2	88D3	88D4	88D5	88D6	88D7	88D8	88D9	88DA	88DB
	Char.	鞞	鞞	鞞	鞞	鞞	鞞	鞞	鞞	鞞	鞞	鞞	鞞	鞞	鞞	鞞	鞞
EF50	IBM	88DC	88DD	88DE	88DF	88E0	88E1	88E2	88E3	88E4	88E5	88E6	88E7	88E8	88E9	88EA	88EB
	Char.	餽	餽	餽	餽	餽	餽	餽	餽	餽	餽	餽	餽	餽	餽	餽	餽
EF60	IBM	88EC	88ED	88EE	88EF	88F0	88F1	88F2	88F3	88F4	88F5	88F6	88F7	88F8	88F9	88FA	88FB
	Char.	駟	駟	駟	駟	駟	駟	駟	駟	駟	駟	駟	駟	駟	駟	駟	駟
EF70	IBM	88FC	88FD	8941	8942	8943	8944	8945	8946	8947	8948	8949	894A	894B	894C	894D	
	Char.	絡	翼	紫	鮓	鮓	鮓	鮓	鮓	鮓	鮓	鮓	鮓	鮓	鮓	鮓	
EFA0	IBM		894E	894F	8950	8951	8952	8953	8954	8955	8956	8957	8958	8959	895A	895B	895C
	Char.		鴿	鴿	鴿	鴿	鴿	鴿	鴿	鴿	鴿	鴿	鴿	鴿	鴿	鴿	鴿
EFB0	IBM	895D	895E	895F	8960	8961	8962	8963	8964	8965	8966	8967	8968	8969	896A	896B	896C
	Char.	敲	龍	龍	龍	龍	龍	龍	龍	龍	龍	龍	龍	龍	龍	龍	龍
EFC0	IBM	896D	896E	896F	8970	8971	8972	8973	8974	8975	8976	8977	8978	8979	897A	897B	897C
	Char.	爨	爨	爨	爨	爨	爨	爨	爨	爨	爨	爨	爨	爨	爨	爨	爨

Table B-4 Big5 à IBM Conversion Table (continued)

Big5		+ 0	+ 1	+ 2	+ 3	+ 4	+ 5	+ 6	+ 7	+ 8	+ 9	+ A	+ B	+ C	+ D	+ E	+ F
EFD0	IBM	897D	897E	897F	8981	8982	8983	8984	8985	8986	8987	8988	8989	898A	898B	898C	898D
	Char.	悽	撻	撻	撻	撻	撻	撻	撻	缺	旆	曠	曠	曠	櫛	櫛	櫛
EFE0	IBM	898E	898F	8990	8991	8992	8993	8994	8995	8996	8997	8998	8999	899A	899B	899C	899D
	Char.	櫛	櫛	櫛	櫛	櫛	櫛	櫛	櫛	馱	豎	豎	演	灑	灑	灑	灑
EFF0	IBM	899E	899F	89A0	89A1	89A2	89A3	89A4	89A5	89A6	89A7	89A8	89A9	89AA	89AB	89AC	
	Char.	灑	灑	灑	灑	灑	灑	灑	灑	灑	灑	灑	灑	灑	灑	灑	
F040	IBM	89AD	89AE	89AF	89B0	89B1	89B2	89B3	89B4	89B5	89B6	89B7	89B8	89B9	89BA	89BB	89BC
	Char.	瓊	瓊	瓊	瓊	瓊	瓊	瓊	瓊	瓊	瓊	瓊	癩	癩	癩	癩	癩
F050	IBM	89BD	89BE	89BF	89C0	89C1	89C2	89C3	89C4	89C5	89C6	89C7	89C8	89C9	89CA	89CB	89CC
	Char.	癩	皴	皴	皴	皴	皴	磨	礪	礪	礪	礪	礪	礪	礪	礪	礪
F060	IBM	89CD	89CE	89CF	89D0	89D1	89D2	89D3	89D4	89D5	89D6	89D7	89D8	89D9	89DA	89DB	89DC
	Char.	籜	籜	籜	籜	籜	籜	籜	籜	籜	籜	籜	籜	籜	籜	籜	籜
F070	IBM	89DD	89DE	89DF	89E0	89E1	89E2	89E3	89E4	89E5	89E6	89E7	89E8	89E9	89EA	89EB	
	Char.	繡	繡	繡	繡	繡	繡	繡	繡	繡	繡	繡	翾	翾	翾	臍	
FOA0	IBM		89EC	89ED	89EE	89EF	89F0	89F1	89F2	89F3	89F4	89F5	89F6	89F7	89F8	89F9	89FA
	Char.		腫	腫	腫	蕁	蕁	蕁	蕁	蕁	蕁	蕁	蕁	蕁	蕁	蕁	蕁
FOB0	IBM	89FB	89FC	89FD	8A41	8A42	8A43	8A44	8A45	8A46	8A47	8A48	8A49	8A4A	8A4B	8A4C	8A4D
	Char.	蠶	蠶	蠶	蠶	蠶	蠶	蠶	蠶	蠶	蠶	蠶	蠶	蠶	蠶	蠶	蠶
FOC0	IBM	8A4E	8A4F	8A50	8A51	8A52	8A53	8A54	8A55	8A56	8A57	8A58	8A59	8A5A	8A5B	8A5C	8A5D
	Char.	蠶	蠶	蠶	蠶	蠶	蠶	蠶	蠶	蠶	蠶	蠶	缺	蠶	蠶	蠶	蠶
FOD0	IBM	8A5E	8A5F	8A60	8A61	8A62	8A63	8A64	8A65	8A66	8A67	8A68	8A69	8A6A	8A6B	8A6C	8A6D
	Char.	蟹	蝶	襖	襖	襖	襖	襖	襖	襖	襖	謫	謫	謫	謫	謫	謫
FOE0	IBM	8A6E	8A6F	8A70	8A71	8A72	8A73	8A74	8A75	8A76	8A77	8A78	8A79	8A7A	8A7B	8A7C	8A7D
	Char.	諧	諧	諷	諷	諷	諷	諷	諷	諷	諷	諷	諷	諷	諷	諷	諷

Table B-4 Big5 à IBM Conversion Table (continued)

Big5		+ 0	+ 1	+ 2	+ 3	+ 4	+ 5	+ 6	+ 7	+ 8	+ 9	+ A	+ B	+ C	+ D	+ E	+ F
FOFO	IBM	8A7E	8A7F	8A81	8A82	8A83	8A84	8A85	8A86	8A87	8A88	8A89	8A8A	8A8B	8A8C	8A8D	
	Char.	獮	獭	獮	蹟	贊	豎	賢	踰	踰	踰	踰	踰	踰	踰	踰	
F140	IBM	8A8E	8A8F	8A90	8A91	8A92	8A93	8A94	8A95	8A96	8A97	8A98	8A99	8A9A	8A9B	8A9C	8A9D
	Char.	踰	踰	踰	踰	踰	踰	踰	踰	踰	踰	踰	踰	踰	踰	踰	踰
F150	IBM	8A9E	8A9F	8AA0	8AA1	8AA2	8AA3	8AA4	8AA5	8AA6	8AA7	8AA8	8AA9	8AAA	8AAB	8AAC	8AAD
	Char.	醜	醜	醜	錄	錄	錄	錄	錄	錄	錄	錄	錄	錄	錄	錄	錄
F160	IBM	8AAE	8AAF	8AB0	8AB1	8AB2	8AB3	8AB4	8AB5	8AB6	8AB7	8AB8	8AB9	8ABA	8ABB	8ABC	8ABD
	Char.	鎡	鎡	鎡	鎡	鎡	鎡	鎡	鎡	鎡	鎡	鎡	鎡	鎡	鎡	鎡	鎡
F170	IBM	8ABE	8ABF	8AC0	8AC1	8AC2	8AC3	8AC4	8AC5	8AC6	8AC7	8AC8	8AC9	8ACA	8ACB	8ACC	
	Char.	輪	藿	嶺	嶺	腰	離	實	靈	靈	靈	靈	靈	靈	靈	靈	
F1A0	IBM		8ACD	8ACE	8ACF	8AD0	8AD1	8AD2	8AD3	8AD4	8AD5	8AD6	8AD7	8AD8	8AD9	8ADA	8ADB
	Char.		鞞	鞞	鞞	鞞	鞞	鞞	鞞	鞞	鞞	鞞	鞞	鞞	鞞	鞞	鞞
F1B0	IBM	8ADC	8ADD	8ADE	8ADF	8AE0	8AE1	8AE2	8AE3	8AE4	8AE5	8AE6	8AE7	8AE8	8AE9	8AEA	8AEB
	Char.	駉	駉	駉	駉	駉	駉	駉	駉	駉	駉	駉	駉	駉	駉	駉	駉
F1C0	IBM	8AEC	8AED	8AEE	8AEF	8AF0	8AF1	8AF2	8AF3	8AF4	8AF5	8AF6	8AF7	8AF8	8AF9	8AFA	8AFB
	Char.	魃	魃	魃	鯨	鯨	鯨	鯨	鯨	鯨	鯨	鯨	鯨	鯨	鯨	鯨	鯨
F1D0	IBM	8AFC	8AFD	8B41	8B42	8B43	8B44	8B45	8B46	8B47	8B48	8B49	8B4A	8B4B	8B4C	8B4D	8B4E
	Char.	鵠	鵠	鵠	鵠	鵠	鵠	鵠	鵠	鵠	鵠	鵠	鵠	鵠	鵠	鵠	鵠
F1E0	IBM	8B4F	8B50	8B51	8B52	8B53	8B54	8B55	8B56	8B57	8B58	8B59	8B5A	8B5B	8B5C	8B5D	8B5E
	Char.	夥	龜	龜	轟	駭	駭	駭	駭	駭	駭	駭	駭	駭	駭	駭	駭
F1F0	IBM	8B5F	8B60	8B61	8B62	8B63	8B64	8B65	8B66	8B67	8B68	8B69	8B6A	8B6B	8B6C	8B6D	
	Char.	嘍	嘍	嘍	嘍	嘍	嘍	嘍	嘍	嘍	嘍	嘍	嘍	嘍	嘍	嘍	
F240	IBM	8B6E	8B6F	8B70	8B71	8B72	8B73	8B74	8B75	8B76	8B77	8B78	8B79	8B7A	8B7B	8B7C	8B7D
	Char.	儻	儻	擻	擻	擻	擻	擻	擻	擻	擻	擻	擻	擻	擻	擻	擻

Table B-4 Big5 à IBM Conversion Table (continued)

Big5	+ 0	+ 1	+ 2	+ 3	+ 4	+ 5	+ 6	+ 7	+ 8	+ 9	+ A	+ B	+ C	+ D	+ E	+ F	
F250	IBM	8B7E	8B7F	8B81	8B82	8B83	8B84	8B85	8B86	8B87	8B88	8B89	8B8A	8B8B	8B8C	8B8D	8B8E
	Char.	樅	榜	樸	臺	梟	糞	櫛	檟	櫟	歎	殞	隴	瀨	瀧	滌	灌
F260	IBM	8B8F	8B90	8B91	8B92	8B93	8B94	8B95	8B96	8B97	8B98	8B99	8B9A	8B9B	8B9C	8B9D	8B9E
	Char.	澱	瀟	澆	滄	瀕	漣	滾	灑	繁	熾	燠	蒸	熨	燻	燼	爆
F270	IBM	8B9F	8BA0	8BA1	8BA2	8BA3	8BA4	8BA5	8BA6	8BA7	8BA8	8BA9	8BAA	8BAB	8BAC	8BAD	
	Char.	擺	擺	擺	璣	璣	璣	璣	璣	璣	璣	璣	璣	璣	璣	璣	
F2A0	IBM		8BAE	8BAF	8BB0	8BB1	8BB2	8BB3	8BB4	8BB5	8BB6	8BB7	8BB8	8BB9	8BBA	8BBB	8BBC
	Char.		磻	磻	磻	磻	磻	磻	磻	磻	磻	磻	磻	磻	磻	磻	磻
F2B0	IBM	8BBD	8BBE	8BBF	8BC0	8BC1	8BC2	8BC3	8BC4	8BC5	8BC6	8BC7	8BC8	8BC9	8BCA	8BCB	8BCC
	Char.	纏	縵	縵	縵	縵	縵	縵	縵	縵	縵	縵	縵	縵	縵	縵	縵
F2C0	IBM	8BCD	8BCE	8BCF	8BD0	8BD1	8BD2	8BD3	8BD4	8BD5	8BD6	8BD7	8BD8	8BD9	8BDA	8BDB	8BDC
	Char.	瞻	臍	臍	臍	臍	臍	臍	臍	臍	臍	臍	臍	臍	臍	臍	臍
F2D0	IBM	8BDD	8BDE	8BDF	8BE0	8BE1	8BE2	8BE3	8BE4	8BE5	8BE6	8BE7	8BE8	8BE9	8BEA	8BEB	8BEC
	Char.	藉	蘆	蘆	蘆	蘆	蘆	蘆	蘆	蘆	蘆	蘆	蘆	蘆	蘆	蘆	蘆
F2E0	IBM	8BED	8BEE	8BEF	8BF0	8BF1	8BF2	8BF3	8BF4	8BF5	8BF6	8BF7	8BF8	8BF9	8BFA	8BFB	8BFC
	Char.	蠟	蟬	蠟	蠟	蠟	蠟	蠟	蠟	蠟	蠟	蠟	蠟	蠟	蠟	蠟	蠟
F2F0	IBM	8BFD	8C41	8C42	8C43	8C44	8C45	8C46	8C47	8C48	8C49	8C4A	8C4B	8C4C	8C4D	8C4E	
	Char.	檢	襍	覈	覈	覈	覈	覈	覈	覈	覈	覈	覈	覈	覈	覈	
F340	IBM	8C4F	8C50	8C51	8C52	8C53	8C54	8C55	8C56	8C57	8C58	8C59	8C5A	8C5B	8C5C	8C5D	8C5E
	Char.	譎	譎	譎	譎	譎	譎	譎	譎	譎	譎	譎	譎	譎	譎	譎	譎
F350	IBM	8C5F	8C60	8C61	8C62	8C63	8C64	8C65	8C66	8C67	8C68	8C69	8C6A	8C6B	8C6C	8C6D	8C6E
	Char.	躑	躑	躑	躑	躑	躑	躑	躑	躑	躑	躑	躑	躑	躑	躑	躑

Table B-4 Big5 à IBM Conversion Table (continued)

Big5		+ 0	+ 1	+ 2	+ 3	+ 4	+ 5	+ 6	+ 7	+ 8	+ 9	+ A	+ B	+ C	+ D	+ E	+ F
F360	IBM	8C6F	8C70	8C71	8C72	8C73	8C74	8C75	8C76	8C77	8C78	8C79	8C7A	8C7B	8C7C	8C7D	8C7E
	Char.	鏽	鏹	鏺	鏻	鏼	鏽	鏾	鏿	鏺	鏻	鏼	鏽	鏾	鏿	鏺	鏻
F370	IBM	8C7F	8C81	8C82	8C83	8C84	8C85	8C86	8C87	8C88	8C89	8C8A	8C8B	8C8C	8C8D	8C8E	
	Char.	鏺	鏻	鏼	鏽	鏾	鏿	鏺	鏻	鏼	鏽	鏾	鏿	鏺	鏻	鏼	
F3A0	IBM		8C8F	8C90	8C91	8C92	8C93	8C94	8C95	8C96	8C97	8C98	8C99	8C9A	8C9B	8C9C	8C9D
	Char.		鏾	鏿	鏺	鏻	鏼	鏽	鏾	鏿	鏺	鏻	鏼	鏽	鏾	鏿	鏺
F3B0	IBM	8C9E	8C9F	8CA0	8CA1	8CA2	8CA3	8CA4	8CA5	8CA6	8CA7	8CA8	8CA9	8CAA	8CAB	8CAC	8CAD
	Char.	鏺	鏻	鏼	鏽	鏾	鏿	鏺	鏻	鏼	鏽	鏾	鏿	鏺	鏻	鏼	鏽
F3C0	IBM	8CAE	8CAF	8CB0	8CB1	8CB2	8CB3	8CB4	8CB5	8CB6	8CB7	8CB8	8CB9	8CBA	8CBB	8CBC	8CBD
	Char.	鏺	鏻	鏼	鏽	鏾	鏿	鏺	鏻	鏼	鏽	鏾	鏿	鏺	鏻	鏼	鏽
F3D0	IBM	8CBE	8CBF	8CC0	8CC1	8CC2	8CC3	8CC4	8CC5	8CC6	8CC7	8CC8	8CC9	8CCA	8CCB	8CCC	8CCD
	Char.	鏺	鏻	鏼	鏽	鏾	鏿	鏺	鏻	鏼	鏽	鏾	鏿	鏺	鏻	鏼	鏽
F3E0	IBM	8CCE	8CCF	8CD0	8CD1	8CD2	8CD3	8CD4	8CD5	8CD6	8CD7	8CD8	8CD9	8CDA	8CDB	8CDC	8CDD
	Char.	鏺	鏻	鏼	鏽	鏾	鏿	鏺	鏻	鏼	鏽	鏾	鏿	鏺	鏻	鏼	鏽
F3F0	IBM	8CDE	8CDF	8CE0	8CE1	8CE2	8CE3	8CE4	8CE5	8CE6	8CE7	8CE8	8CE9	8CEA	8CEB	8CEC	
	Char.	鏺	鏻	鏼	鏽	鏾	鏿	鏺	鏻	鏼	鏽	鏾	鏿	鏺	鏻	鏼	
F440	IBM	8CED	8CEE	8CEF	8CF0	8CF1	8CF2	8CF3	8CF4	8CF5	8CF6	8CF7	8CF8	8CF9	8CFA	8CFB	8CFC
	Char.	鏺	鏻	鏼	鏽	鏾	鏿	鏺	鏻	鏼	鏽	鏾	鏿	鏺	鏻	鏼	鏽
F450	IBM	8CFD	8D41	8D42	8D43	8D44	8D45	8D46	8D47	8D48	8D49	8D4A	8D4B	8D4C	8D4D	8D4E	8D4F
	Char.	鏺	鏻	鏼	鏽	鏾	鏿	鏺	鏻	鏼	鏽	鏾	鏿	鏺	鏻	鏼	鏽
F460	IBM	8D50	8D51	8D52	8D53	8D54	8D55	8D56	8D57	8D58	8D59	8D5A	8D5B	8D5C	8D5D	8D5E	8D5F
	Char.	鏺	鏻	鏼	鏽	鏾	鏿	鏺	鏻	鏼	鏽	鏾	鏿	鏺	鏻	鏼	鏽
F470	IBM	8D60	8D61	8D62	8D63	8D64	8D65	8D66	8D67	8D68	8D69	8D6A	8D6B	8D6C	8D6D	8D6E	
	Char.	鏺	鏻	鏼	鏽	鏾	鏿	鏺	鏻	鏼	鏽	鏾	鏿	鏺	鏻	鏼	

Table B-4 Big5 à IBM Conversion Table (continued)

Big5		+ 0	+ 1	+ 2	+ 3	+ 4	+ 5	+ 6	+ 7	+ 8	+ 9	+ A	+ B	+ C	+ D	+ E	+ F
F4A0	IBM		8D6F	8D70	8D71	8D72	8D73	8D74	8D75	8D76	8D77	8D78	8D79	8D7A	8D7B	8D7C	8D7D
	Char.		禡	樵	穡	穉	穉	簞	簞	簞	簞	簞	簞	簞	簞	簞	簞
F4B0	IBM	8D7E	8D7F	8D81	8D82	8D83	8D84	8D85	8D86	8D87	8D88	8D89	8D8A	8D8B	8D8C	8D8D	8D8E
	Char.	孺	翻	睜	臙	臙	臙	臙	臙	臙	臙	臙	臙	臙	臙	臙	臙
F4C0	IBM	8D8F	8D90	8D91	8D92	8D93	8D94	8D95	8D96	8D97	8D98	8D99	8D9A	8D9B	8D9C	8D9D	8D9E
	Char.	蔘	蔘	蔘	蔘	蔘	蔘	蔘	蔘	蔘	蔘	蔘	蔘	蔘	蔘	蔘	蔘
F4D0	IBM	8D9F	8DA0	8DA1	8DA2	8DA3	8DA4	8DA5	8DA6	8DA7	8DA8	8DA9	8DAA	8DAB	8DAC	8DAD	8DAE
	Char.	誨	誨	誨	誨	誨	誨	誨	誨	誨	誨	誨	誨	誨	誨	誨	誨
F4E0	IBM	8DAF	8DB0	8DB1	8DB2	8DB3	8DB4	8DB5	8DB6	8DB7	8DB8	8DB9	8DBA	8DBB	8DBC	8DBD	8DBE
	Char.	邊	鄺	鄺	醜	醜	醜	醜	錫	鍬	鍬	鍬	鍬	鍬	鍬	鍬	鍬
F4F0	IBM	8DBF	8DC0	8DC1	8DC2	8DC3	8DC4	8DC5	8DC6	8DC7	8DC8	8DC9	8DCA	8DCB	8DCC	8DCD	
	Char.	鑽	鑽	鑽	鑽	鑽	鑽	鑽	鑽	鑽	鑽	鑽	鑽	鑽	鑽	鑽	
F540	IBM	8DCE	8DCF	8DD0	8DD1	8DD2	8DD3	8DD4	8DD5	8DD6	8DD7	8DD8	8DD9	8DDA	8ddb	8DDC	8DDD
	Char.	鍊	鍊	鍊	鎊	鎊	閩	閩	閩	霰	霰	鞞	鞞	鎰	聲	顛	顛
F550	IBM	8DDE	8DDF	8DE0	8DE1	8DE2	8DE3	8DE4	8DE5	8DE6	8DE7	8DE8	8DE9	8DEA	8DEB	8DEC	8DED
	Char.	顛	顛	顛	顛	顛	顛	顛	顛	顛	顛	駢	駢	駢	駢	駢	駢
F560	IBM	8DEE	8DEF	8DF0	8DF1	8DF2	8DF3	8DF4	8DF5	8DF6	8DF7	8DF8	8DF9	8DFA	8DFB	8DFC	8DFD
	Char.	駢	駢	駢	駢	駢	駢	駢	駢	駢	駢	駢	駢	駢	駢	駢	駢
F570	IBM	8E41	8E42	8E43	8E44	8E45	8E46	8E47	8E48	8E49	8E4A	8E4B	8E4C	8E4D	8E4E	8E4F	
	Char.	駢	駢	駢	駢	駢	駢	駢	駢	駢	駢	駢	駢	駢	駢	駢	
F5A0	IBM		8E50	8E51	8E52	8E53	8E54	8E55	8E56	8E57	8E58	8E59	8E5A	8E5B	8E5C	8E5D	8E5E
	Char.		鷓	鷓	鷓	鷓	鷓	鷓	鷓	鷓	鷓	鷓	鷓	鷓	鷓	鷓	鷓
F5B0	IBM	8E5F	8E60	8E61	8E62	8E63	8E64	8E65	8E66	8E67	8E68	8E69	8E6A	8E6B	8E6C	8E6D	8E6E
	Char.	鷓	鷓	鷓	鷓	鷓	鷓	鷓	鷓	鷓	鷓	鷓	鷓	鷓	鷓	鷓	鷓

Table B-4 Big5 à IBM Conversion Table (continued)

Big5		+ 0	+ 1	+ 2	+ 3	+ 4	+ 5	+ 6	+ 7	+ 8	+ 9	+ A	+ B	+ C	+ D	+ E	+ F
F5C0	IBM	8E6F	8E70	8E71	8E72	8E73	8E74	8E75	8E76	8E77	8E78	8E79	8E7A	8E7B	8E7C	8E7D	8E7E
	Char.	儼	儼	刷	劑	嗽	噴	唯	嫻	嫻	嫻	嫻	嫻	嫻	嫻	嫻	嫻
F5D0	IBM	8E7F	8E81	8E82	8E83	8E84	8E85	8E86	8E87	8E88	8E89	8E8A	8E8B	8E8C	8E8D	8E8E	8E8F
	Char.	機	機	機	機	機	機	機	機	機	機	機	機	機	機	機	機
F5E0	IBM	8E90	8E91	8E92	8E93	8E94	8E95	8E96	8E97	8E98	8E99	8E9A	8E9B	8E9C	8E9D	8E9E	8E9F
	Char.	矚	矚	矚	矚	矚	矚	矚	矚	矚	矚	矚	矚	矚	矚	矚	矚
F5F0	IBM	8EA0	8EA1	8EA2	8EA3	8EA4	8EA5	8EA6	8EA7	8EA8	8EA9	8EAA	8EAB	8EAC	8EAD	8EAE	
	Char.	羸	羸	羸	羸	羸	羸	羸	羸	羸	羸	羸	羸	羸	羸	羸	
F640	IBM	8EAF	8EB0	8EB1	8EB2	8EB3	8EB4	8EB5	8EB6	8EB7	8EB8	8EB9	8EBA	8EBB	8EBC	8EBD	8EBE
	Char.	蠟	蠟	蠟	蠟	蠟	蠟	蠟	蠟	蠟	蠟	蠟	蠟	蠟	蠟	蠟	蠟
F650	IBM	8EBF	8EC0	8EC1	8EC2	8EC3	8EC4	8EC5	8EC6	8EC7	8EC8	8EC9	8ECA	8ECB	8ECC	8ECD	8ECE
	Char.	礙	譽	贖	鼎	趨	躡	躡	躡	躡	躡	躡	躡	躡	躡	躡	躡
F660	IBM	8ECF	8ED0	8ED1	8ED2	8ED3	8ED4	8ED5	8ED6	8ED7	8ED8	8ED9	8EDA	8EDB	8EDC	8EDD	8EDE
	Char.	鑲	鑲	鑲	鑲	鑲	鑲	鑲	鑲	鑲	鑲	鑲	鑲	鑲	鑲	鑲	鑲
F670	IBM	8EDF	8EE0	8EE1	8EE2	8EE3	8EE4	8EE5	8EE6	8EE7	8EE8	8EE9	8EEA	8EEB	8EEC	8EED	
	Char.	鞮	鞮	鞮	鞮	鞮	鞮	鞮	鞮	鞮	鞮	鞮	鞮	鞮	鞮	鞮	
F6A0	IBM		8EEE	8EEF	8EF0	8EF1	8EF2	8EF3	8EF4	8EF5	8EF6	8EF7	8EF8	8EF9	8EFA	8EFB	8EFC
	Char.		驛	驛	驛	驛	驛	驛	驛	驛	驛	驛	驛	驛	驛	驛	驛
F6B0	IBM	8EFD	8F41	8F42	8F43	8F44	8F45	8F46	8F47	8F48	8F49	8F4A	8F4B	8F4C	8F4D	8F4E	8F4F
	Char.	鯽	鯽	鵠	鵠	鵠	鵠	鵠	鵠	鵠	鵠	鵠	鵠	鵠	鵠	鵠	鵠
F6C0	IBM	8F50	8F51	8F52	8F53	8F54	8F55	8F56	8F57	8F58	8F59	8F5A	8F5B	8F5C	8F5D	8F5E	8F5F
	Char.	鵠	鵠	鵠	鵠	鵠	鵠	鵠	鵠	鵠	鵠	鵠	鵠	鵠	鵠	鵠	鵠
F6D0	IBM	8F60	8F61	8F62	8F63	8F64	8F65	8F66	8F67	8F68	8F69	8F6A	8F6B	8F6C	8F6D	8F6E	8F6F
	Char.	葵	葵	葵	葵	葵	葵	葵	葵	葵	葵	葵	葵	葵	葵	葵	葵

Table B-4 Big5 à IBM Conversion Table (continued)

Big5		+ 0	+ 1	+ 2	+ 3	+ 4	+ 5	+ 6	+ 7	+ 8	+ 9	+ A	+ B	+ C	+ D	+ E	+ F
F6E0	IBM	8F70	8F71	8F72	8F73	8F74	8F75	8F76	8F77	8F78	8F79	8F7A	8F7B	8F7C	8F7D	8F7E	8F7F
	Char.	攤	攤	攤	攢	權	樞	機	氈	灘	灘	潰	熾	燿	犖	纓	
F6F0	IBM	8F81	8F82	8F83	8F84	8F85	8F86	8F87	8F88	8F89	8F8A	8F8B	8F8C	8F8D	8F8E	8F8F	
	Char.	璫	璽	璣	璫	瘦	嶠	礪	論	穰	穉	簞	簞	籜	籜	簞	
F740	IBM	8F90	8F91	8F92	8F93	8F94	8F95	8F96	8F97	8F98	8F99	8F9A	8F9B	8F9C	8F9D	8F9E	8F9F
	Char.	籜	籜	籜	籜	羈	羈	羈	羈	羈	羈	羈	羈	羈	羈	羈	羈
F750	IBM	8FA0	8FA1	8FA2	8FA3	8FA4	8FA5	8FA6	8FA7	8FA8	8FA9	8FAA	8FAB	8FAC	8FAD	8FAE	8FAF
	Char.	蟹	蟹	襠	覲	覲	籐	籐	籐	諠	諠	諠	諠	諠	躡	躡	躡
F760	IBM	8FB0	8FB1	8FB2	8FB3	8FB4	8FB5	8FB6	8FB7	8FB8	8FB9	8FBA	8FBB	8FBC	8FBD	8FBE	8FBF
	Char.	躡	躡	躡	躡	輻	輻	鄮	鑛	鑛	鑛	鑿	鑿	鑿	鑿	鑿	鑿
F770	IBM	8FC0	8FC1	8FC2	8FC3	8FC4	8FC5	8FC6	8FC7	8FC8	8FC9	8FCA	8FCB	8FCC	8FCD	8FCE	
	Char.	對	霧	鞞	顛	顛	颯	颯	鑿	驕	驕	驕	驕	驕	驕	驕	
F7A0	IBM		8FCF	8FD0	8FD1	8FD2	8FD3	8FD4	8FD5	8FD6	8FD7	8FD8	8FD9	8FDA	8FDB	8FDC	8FDD
	Char.		驢	驢	驢	驢	驢	閩	鬻	魘	魘	鯨	鯨	鯨	鯨	鯨	鯨
F7B0	IBM	8FDE	8FDF	8FE0	8FE1	8FE2	8FE3	8FE4	8FE5	8FE6	8FE7	8FE8	8FE9	8FEA	8FEB	8FEC	8FED
	Char.	鯨	鯨	鯨	鯨	鯨	鯨	鯨	鸚	鸚	鸚	鸚	鸚	鸚	鸚	鸚	鸚
F7C0	IBM	8FEE	8FEF	8FF0	8FF1	8FF2	8FF3	8FF4	8FF5	8FF6	8FF7	8FF8	8FF9	8FFA	8FFB	8FFC	8FFD
	Char.	驚	驚	驚	驚	鸚	鸚	鸚	鸚	鸚	鸚	鸚	鸚	鸚	鸚	鸚	鸚
F7D0	IBM	9041	9042	9043	9044	9045	9046	9047	9048	9049	904A	904B	904C	904D	904E	904F	9050
	Char.	儻	釗	豐	壩	羈	羈	巖	巖	巖	巖	巖	攢	攢	攢	壩	羈
F7E0	IBM	9051	9052	9053	9054	9055	9056	9057	9058	9059	905A	905B	905C	905D	905E	905F	9060
	Char.	攢	攢	攢	攢	灑	灑	灑	灑	灑	攢	攢	攢	攢	攢	攢	攢
F7F0	IBM	9061	9062	9063	9064	9065	9066	9067	9068	9069	906A	906B	906C	906D	906E	906F	
	Char.	離	壩	穰	藜	藜	繫	瓊	蠟	蠟	蠟	蠟	蠟	蠟	蠟	蠟	

Table B-4 Big5 à IBM Conversion Table (continued)

Big5		+ 0	+ 1	+ 2	+ 3	+ 4	+ 5	+ 6	+ 7	+ 8	+ 9	+ A	+ B	+ C	+ D	+ E	+ F
F840	IBM	9070	9071	9072	9073	9074	9075	9076	9077	9078	9079	907A	907B	907C	907D	907E	907F
	Char.	讖	讖	讖	讖	讖	贊	躑	躑	躑	躑	躑	躑	躑	躑	躑	躑
F850	IBM	9081	9082	9083	9084	9085	9086	9087	9088	9089	908A	908B	908C	908D	908E	908F	9090
	Char.	鞣	護	職	驢	震	鬢	鬢	鯨	鯨	鯨	鯨	鯨	鯨	鯨	鯨	鯨
F860	IBM	9091	9092	9093	9094	9095	9096	9097	9098	9099	909A	909B	909C	909D	909E	909F	90A0
	Char.	鷗	鷗	鷗	鷗	鷗	鷗	鷗	鷗	鷗	鷗	鷗	鷗	鷗	鷗	鷗	鷗
F870	IBM	90A1	90A2	90A3	90A4	90A5	90A6	90A7	90A8	90A9	90AA	90AB	90AC	90AD	90AE	90AF	
	Char.	鵬	鵬	鵬	鵬	廣	鵠	鵠	鵠	鵠	鵠	鵠	鵠	鵠	鵠	鵠	
F8A0	IBM		90B0	90B1	90B2	90B3	90B4	90B5	90B6	90B7	90B8	90B9	90BA	90BB	90BC	90BD	90BE
	Char.		齧	齧	齧	齧	齧	齧	齧	齧	齧	齧	齧	齧	齧	齧	齧
F8B0	IBM	90BF	90C0	90C1	90C2	90C3	90C4	90C5	90C6	90C7	90C8	90C9	90CA	90CB	90CC	90CD	90CE
	Char.	澆	燻	嗽	齶	贊	磧	瀕	潰	筴	繡	繡	艘	藻	蠟	蠟	蠟
F8C0	IBM	90CF	90D0	90D1	90D2	90D3	90D4	90D5	90D6	90D7	90D8	90D9	90DA	90DB	90DC	90DD	90DE
	Char.	盡	讒	調	躑	躑	躑	躑	躑	躑	躑	躑	躑	躑	躑	躑	躑
F8D0	IBM	90DF	90E0	90E1	90E2	90E3	90E4	90E5	90E6	90E7	90E8	90E9	90EA	90EB	90EC	90ED	90EE
	Char.	龜	贛	贛	贛	贛	贛	贛	贛	贛	贛	贛	贛	贛	贛	贛	贛
F8E0	IBM	90EF	90F0	90F1	90F2	90F3	90F4	90F5	90F6	90F7	90F8	90F9	90FA	90FB	90FC	90FD	9141
	Char.	鷗	鷗	鷗	鷗	鷗	鷗	鷗	鷗	鷗	鷗	鷗	鷗	鷗	鷗	鷗	鷗
F8F0	IBM	9142	9143	9144	9145	9146	9147	9148	9149	914A	914B	914C	914D	914E	914F	9150	
	Char.	斷	櫛	櫛	櫛	櫛	灑	灑	灑	灑	灑	灑	灑	灑	灑	灑	
F940	IBM	9151	9152	9153	9154	9155	9156	9157	9158	9159	915A	915B	915C	915D	915E	915F	9160
	Char.	纘	纘	纘	纘	纘	纘	纘	纘	纘	纘	纘	纘	纘	纘	纘	纘
F950	IBM	9161	9162	9163	9164	9165	9166	9167	9168	9169	916A	916B	916C	916D	916E	916F	9170
	Char.	躑	躑	躑	躑	躑	躑	躑	躑	躑	躑	躑	躑	躑	躑	躑	躑

Table B-4 Big5 à IBM Conversion Table (continued)

Big5		+ 0	+ 1	+ 2	+ 3	+ 4	+ 5	+ 6	+ 7	+ 8	+ 9	+ A	+ B	+ C	+ D	+ E	+ F
F960	IBM	9171	9172	9173	9174	9175	9176	9177	9178	9179	917A	917B	917C	917D	917E	917F	9181
	Char.	鷓	鸞	鸞	麕	麕	鼈	鼈	鼈	鼈	鼈	鼈	鼈	鼈	鼈	鼈	鼈
F970	IBM	9182	9183	9184	9185	9186	9187	9188	9189	918A	918B	918C	918D	918E	918F	9190	
	Char.	躑	躑	躑	躑	躑	躑	躑	躑	躑	躑	躑	躑	躑	躑	躑	
F9A0	IBM		9191	9192	9193	9194	9195	9196	9197	9198	9199	919A	919B	919C	919D	919E	919F
	Char.		鰓	鰓	鰓	鰓	鰓	鰓	鰓	鰓	鰓	鰓	鰓	鰓	鰓	鰓	鰓
F9B0	IBM	91A0	91A1	91A2	91A3	91A4	91A5	91A6	91A7	91A8	91A9	91AA	91AB	91AC	91AD	91AE	91AF
	Char.	鰓	鰓	鰓	鰓	鰓	鰓	鰓	鰓	鰓	鰓	鰓	鰓	鰓	鰓	鰓	鰓
F9C0	IBM	91B0	91B1	91B2	91B3	91B4	91B5	91B6	91B7	91B8	91B9	91BA	91BB	91BC	91BD	91BE	91BF
	Char.	鰓	鰓	鰓	鰓	鰓	鰓	鰓	鰓	鰓	鰓	鰓	鰓	鰓	鰓	鰓	鰓
F9D0	IBM	91C0	91C1	91C2	91C3	91C4	91C5	FFFF	FFFF	FFFF	FFFF	FFFF	FFFF	FFFF	FFFF	FFFF	FFFF
	Char.	鰓	鰓	鰓	鰓	鰓	鰓										
F9E0	IBM	FFFF	FFFF	FFFF	FFFF	FFFF	FFFF	FFFF	FFFF	FFFF	FFFF	FFFF	FFFF	FFFF	FFFF	FFFF	FFFF
	Char.																
F9F0	IBM	FFFF	FFFF	FFFF	FFFF	FFFF	FFFF	FFFF	FFFF	FFFF	FFFF	FFFF	FFFF	FFFF	FFFF	FFFF	FFFF
	Char.																
FA40	IBM	FFFF	FFFF	FFFF	FFFF	FFFF	FFFF	FFFF	FFFF	FFFF	FFFF	FFFF	FFFF	FFFF	FFFF	FFFF	FFFF
	Char.																
FA50	IBM	FFFF	FFFF	FFFF	FFFF	FFFF	FFFF	FFFF	FFFF	FFFF	FFFF	FFFF	FFFF	FFFF	FFFF	FFFF	FFFF
	Char.																
FA60	IBM	FFFF	FFFF	FFFF	FFFF	FFFF	FFFF	FFFF	FFFF	FFFF	FFFF	FFFF	FFFF	FFFF	FFFF	FFFF	FFFF
	Char.																
FA70	IBM	FFFF	FFFF	FFFF	FFFF	FFFF	FFFF	FFFF	FFFF	FFFF	FFFF	FFFF	FFFF	FFFF	FFFF	FFFF	FFFF
	Char.																

Table B-4 Big5 à IBM Conversion Table (continued)

Big5		+ 0	+ 1	+ 2	+ 3	+ 4	+ 5	+ 6	+ 7	+ 8	+ 9	+ A	+ B	+ C	+ D	+ E	+ F
FAAO	IBM		FFFF	FFFF	FFFF	FFFF	FFFF	FFFF	FFFF	FFFF	FFFF	FFFF	FFFF	FFFF	FFFF	FFFF	FFFF
	Char.																
FABO	IBM	FFFF	FFFF	FFFF	FFFF	FFFF	FFFF	FFFF	FFFF	FFFF	FFFF	FFFF	FFFF	FFFF	FFFF	FFFF	FFFF
	Char.																
FACO	IBM	FFFF	FFFF	FFFF	FFFF	FFFF	FFFF	FFFF	FFFF	FFFF	FFFF	FFFF	FFFF	FFFF	FFFF	FFFF	FFFF
	Char.																
FADO	IBM	FFFF	FFFF	FFFF	FFFF	FFFF	FFFF	FFFF	FFFF	FFFF	FFFF	FFFF	FFFF	FFFF	FFFF	FFFF	FFFF
	Char.																
FAEO	IBM	FFFF	FFFF	FFFF	FFFF	FFFF	FFFF	FFFF	FFFF	FFFF	FFFF	FFFF	FFFF	FFFF	FFFF	FFFF	FFFF
	Char.																
FAFO	IBM	FFFF	FFFF	FFFF	FFFF	FFFF	FFFF	FFFF	FFFF	FFFF	FFFF	FFFF	FFFF	FFFF	FFFF	FFFF	FFFF
	Char.																
FB4O	IBM	FFFF	FFFF	FFFF	FFFF	FFFF	FFFF	FFFF	FFFF	FFFF	FFFF	FFFF	FFFF	FFFF	FFFF	FFFF	FFFF
	Char.																
FB5O	IBM	FFFF	FFFF	FFFF	FFFF	FFFF	FFFF	FFFF	FFFF	FFFF	FFFF	FFFF	FFFF	FFFF	FFFF	FFFF	FFFF
	Char.																
FB6O	IBM	FFFF	FFFF	FFFF	FFFF	FFFF	FFFF	FFFF	FFFF	FFFF	FFFF	FFFF	FFFF	FFFF	FFFF	FFFF	FFFF
	Char.																
FB7O	IBM	FFFF	FFFF	FFFF	FFFF	FFFF	FFFF	FFFF	FFFF	FFFF	FFFF	FFFF	FFFF	FFFF	FFFF	FFFF	FFFF
	Char.																
FBAO	IBM		FFFF	FFFF	FFFF	FFFF	FFFF	FFFF	FFFF	FFFF	FFFF	FFFF	FFFF	FFFF	FFFF	FFFF	FFFF
	Char.																

Table B-4 Big5 à IBM Conversion Table (continued)

Big5		+ 0	+ 1	+ 2	+ 3	+ 4	+ 5	+ 6	+ 7	+ 8	+ 9	+ A	+ B	+ C	+ D	+ E	+ F
FBBO	IBM	FFFF	FFFF	FFFF	FFFF	FFFF	FFFF	FFFF	FFFF	FFFF	FFFF	FFFF	FFFF	FFFF	FFFF	FFFF	FFFF
	Char.																
FBCO	IBM	FFFF	FFFF	FFFF	FFFF	FFFF	FFFF	FFFF	FFFF	FFFF	FFFF	FFFF	FFFF	FFFF	FFFF	FFFF	FFFF
	Char.																
FBD0	IBM	FFFF	FFFF	FFFF	FFFF	FFFF	FFFF	FFFF	FFFF	FFFF	FFFF	FFFF	FFFF	FFFF	FFFF	FFFF	FFFF
	Char.																
FBE0	IBM	FFFF	FFFF	FFFF	FFFF	FFFF	FFFF	FFFF	FFFF	FFFF	FFFF	FFFF	FFFF	FFFF	FFFF	FFFF	FFFF
	Char.																
FBFO	IBM	FFFF	FFFF	FFFF	FFFF	FFFF	FFFF	FFFF	FFFF	FFFF	FFFF	FFFF	FFFF	FFFF	FFFF	FFFF	FFFF
	Char.																
FC40	IBM	FFFF	FFFF	FFFF	FFFF	FFFF	FFFF	FFFF	FFFF	FFFF	FFFF	FFFF	FFFF	FFFF	FFFF	FFFF	FFFF
	Char.																
FC50	IBM	FFFF	FFFF	FFFF	FFFF	FFFF	FFFF	FFFF	FFFF	FFFF	FFFF	FFFF	FFFF	FFFF	FFFF	FFFF	FFFF
	Char.																
FC60	IBM	FFFF	FFFF	FFFF	FFFF	FFFF	FFFF	FFFF	FFFF	FFFF	FFFF	FFFF	FFFF	FFFF	FFFF	FFFF	FFFF
	Char.																
FC70	IBM	FFFF	FFFF	FFFF	FFFF	FFFF	FFFF	FFFF	FFFF	FFFF	FFFF	FFFF	FFFF	FFFF	FFFF	FFFF	FFFF
	Char.																
FCA0	IBM		FFFF	FFFF	FFFF	FFFF	FFFF	FFFF	FFFF	FFFF	FFFF	FFFF	FFFF	FFFF	FFFF	FFFF	FFFF
	Char.																
FCB0	IBM	FFFF	FFFF	FFFF	FFFF	FFFF	FFFF	FFFF	FFFF	FFFF	FFFF	FFFF	FFFF	FFFF	FFFF	FFFF	FFFF
	Char.																
FCC0	IBM	FFFF	FFFF	FFFF	FFFF	FFFF	FFFF	FFFF	FFFF	FFFF	FFFF	FFFF	FFFF	FFFF	FFFF	FFFF	FFFF
	Char.																

Table B-4 Big5 à IBM Conversion Table (continued)

Big5		+ 0	+ 1	+ 2	+ 3	+ 4	+ 5	+ 6	+ 7	+ 8	+ 9	+ A	+ B	+ C	+ D	+ E	+ F
FCD0	IBM	FFFF	FFFF	FFFF	FFFF	FFFF	FFFF	FFFF	FFFF	FFFF	FFFF	FFFF	FFFF	FFFF	FFFF	FFFF	FFFF
	Char.																
FCE0	IBM	FFFF	FFFF	FFFF	FFFF	FFFF	FFFF	FFFF	FFFF	FFFF	FFFF	FFFF	FFFF	FFFF	FFFF	FFFF	FFFF
	Char.																
FCF0	IBM	FFFF	FFFF	FFFF	FFFF	FFFF	FFFF	FFFF	FFFF	FFFF	FFFF	FFFF	FFFF	FFFF	FFFF	FFFF	FFFF
	Char.																
FD40	IBM	FFFF	FFFF	FFFF	FFFF	FFFF	FFFF	FFFF	FFFF	FFFF	FFFF	FFFF	FFFF	FFFF	FFFF	FFFF	FFFF
	Char.																
FD50	IBM	FFFF	FFFF	FFFF	FFFF	FFFF	FFFF	FFFF	FFFF	FFFF	FFFF	FFFF	FFFF	FFFF	FFFF	FFFF	FFFF
	Char.																
FD60	IBM	FFFF	FFFF	FFFF	FFFF	FFFF	FFFF	FFFF	FFFF	FFFF	FFFF	FFFF	FFFF	FFFF	FFFF	FFFF	FFFF
	Char.																
FD70	IBM	FFFF	FFFF	FFFF	FFFF	FFFF	FFFF	FFFF	FFFF	FFFF	FFFF	FFFF	FFFF	FFFF	FFFF	FFFF	FFFF
	Char.																
FDA0	IBM		FFFF	FFFF	FFFF	FFFF	FFFF	FFFF	FFFF	FFFF	FFFF	FFFF	FFFF	FFFF	FFFF	FFFF	FFFF
	Char.																
FDB0	IBM	FFFF	FFFF	FFFF	FFFF	FFFF	FFFF	FFFF	FFFF	FFFF	FFFF	FFFF	FFFF	FFFF	FFFF	FFFF	FFFF
	Char.																
FDC0	IBM	FFFF	FFFF	FFFF	FFFF	FFFF	FFFF	FFFF	FFFF	FFFF	FFFF	FFFF	FFFF	FFFF	FFFF	FFFF	FFFF
	Char.																
FDD0	IBM	FFFF	FFFF	FFFF	FFFF	FFFF	FFFF	FFFF	FFFF	FFFF	FFFF	FFFF	FFFF	FFFF	FFFF	FFFF	FFFF
	Char.																
FDE0	IBM	FFFF	FFFF	FFFF	FFFF	FFFF	FFFF	FFFF	FFFF	FFFF	FFFF	FFFF	FFFF	FFFF	FFFF	FFFF	FFFF
	Char.																

Table B-4 Big5 à IBM Conversion Table (continued)

Big5		+ 0	+ 1	+ 2	+ 3	+ 4	+ 5	+ 6	+ 7	+ 8	+ 9	+ A	+ B	+ C	+ D	+ E	+ F
FDFO	IBM	FFFF	FFFF	FFFF	FFFF	FFFF	FFFF	FFFF	FFFF	FFFF	FFFF	FFFF	FFFF	FFFF	FFFF	FFFF	
	Char.																
FE40	IBM	FFFF	FFFF	FFFF	FFFF	FFFF	FFFF	FFFF	FFFF	FFFF	FFFF	FFFF	FFFF	FFFF	FFFF	FFFF	FFFF
	Char.																
FE50	IBM	FFFF	FFFF	FFFF	FFFF	FFFF	FFFF	FFFF	FFFF	FFFF	FFFF	FFFF	FFFF	FFFF	FFFF	FFFF	FFFF
	Char.																
FE60	IBM	FFFF	FFFF	FFFF	FFFF	FFFF	FFFF	FFFF	FFFF	FFFF	FFFF	FFFF	FFFF	FFFF	FFFF	FFFF	FFFF
	Char.																
FE70	IBM	FFFF	FFFF	FFFF	FFFF	FFFF	FFFF	FFFF	FFFF	FFFF	FFFF	FFFF	FFFF	FFFF	FFFF	FFFF	
	Char.																
FEA0	IBM		FFFF	FFFF	FFFF	FFFF	FFFF	FFFF	FFFF	FFFF	FFFF	FFFF	FFFF	FFFF	FFFF	FFFF	FFFF
	Char.																
FEBO	IBM	FFFF	FFFF	FFFF	FFFF	FFFF	FFFF	FFFF	FFFF	FFFF	FFFF	FFFF	FFFF	FFFF	FFFF	FFFF	FFFF
	Char.																
FECO	IBM	FFFF	FFFF	FFFF	FFFF	FFFF	FFFF	FFFF	FFFF	FFFF	FFFF	FFFF	FFFF	FFFF	FFFF	FFFF	FFFF
	Char.																
FEDO	IBM	FFFF	FFFF	FFFF	FFFF	FFFF	FFFF	FFFF	FFFF	FFFF	FFFF	FFFF	FFFF	FFFF	FFFF	FFFF	FFFF
	Char.																
FEE0	IBM	FFFF	FFFF	FFFF	FFFF	FFFF	FFFF	FFFF	FFFF	FFFF	FFFF	FFFF	FFFF	FFFF	FFFF	FFFF	FFFF
	Char.																
FEFO	IBM	FFFF	FFFF	FFFF	FFFF	FFFF	FFFF	FFFF	FFFF	FFFF	FFFF	FFFF	FFFF	FFFF	FFFF	FFFF	
	Char.																



EBCDIC-ASCII Code Conversion

Table C-1 lists the EBCDIC-ASCII code conversions performed by the default code conversion table which is provided with FCU (see Table 2-1).

Table C- 1 Default FCU EBCDIC-ASCII Conversions

Hex	EBCDIC	ASCII	Hex	EBCDIC	ASCII	Hex	EBCDIC	ASCII	Hex	EBCDIC	ASCII
00	NUL	NUL	20	DS		40	SP	DS	60	-	ENQ
01	SOH	SOH	21	SOS	a	41			61	/	BEL
02	STX	STX	22	FS	b	42			62		
03	ETX	ETX	23		c	43		s	63		
04	PF		24	BYP	d	44		t	64		
05	HT	RLF	25	LF	SMM	45		u	65		
06	LC	f	26	ETB	IL	46		v	66		
07	DEL	"	27	ESC	CUI	47		w	67		
08	GE	p	28		h	48		x	68		
09	RLF		29		i	49		y	69		
0A	SMM		2A	SW		4A		N	6A		
0B	VT	VT	2B	CUI		4B	.	ACK	6B	,	
0C	FF	FF	2C			4C	<	DC4	6C	%	LF
0D	CR	CR	2D	ENQ	HT	4D	(6D	_	~
0E	SO	SO	2E	ACK	LC	4E	+	CUI	6E	>	
0F	SI	SI	2F	BEL	DEL	4F		@	6F	?	SUB
10	DLE	DLE	30			50	&	ETB	70		
11	DC1	DC1	31		j	51		z	71		
12	DC2	DC2	32	SYN	BS	52			72		
13	DC3	DC3	33		l	53			73]
14	TM		34	PN	m	54			74		
15		e	35	RS	n	55		[75		
16	BS	GE	36	UC	o	56			76		{
17	IL	g	37	EOT	PF	57			77		A
18	CAN	CAN	38		q	58			78		B
19	EM	EM	39		r	59			79	'	-

Hex	EBCDIC	ASCII	Hex	EBCDIC	ASCII	Hex	EBCDIC	ASCII	Hex	EBCDIC	ASCII
1A	CC	k	3A		^	5A	!	SOS	7A	:	
1B	CUI		3B	CU3		5B	\$	BYP	7B	#	
1C	IFS	IFS	3C	DC4	TM	5C	*	SW	7C	@	SP
1D	IGS	IGS	3D	NAK		5D)		7D	'	ESC
1E	IRS	IRS	3E			5E	:	CU3	7E	=	NAK
1F	IUS	IUS	3F	SUB	CC	5F	~	=	7F	"	FS
80		C	A0		J	C0	{	#	E0	\	*
81	a	/	A1		V	C1	A		E1		
82	b		A2	s		C2	B		E2	S	
83	c		A3	t		C3	C		E3	T	
84	d		A4	u		C4	D		E4	U	
85	e		A5	v		C5	E		E5	V	
86	f		A6	w		C6	F		E6	W	
87	g		A7	x		C7	G		E7	X	
88	h		A8	y	'	C8	H		E8	Y	
89	i		A9	z	:	C9	I		E9	Z	!
8A		D	AA		K	CA		Y	EA		4
8B		E	AB		L	CB		Z	EB		5
8C		F	AC		M	CC			EC		6
8D		G	AD	[\$	CD			ED		7
8E		H	AE		O	CE			EE		8
8F		I	AF		P	CF			EF		9
90			B0		Q	D0	}	'	F0	0	
91	j		B1		R	D1	J		F1	1	
92	k	,	B2			D2	K	.	F2	2	SYN
93	l	%	B3			D3	L	<	F3	3	
94	m	_	B4			D4	M	(F4	4	PN
95	n	>	B5			D5	N	+	F5	5	RS
96	o	?	B6			D6	O		F6	6	UC
97	p		B7			D7	P	&	F7	7	EOT
98	q		B8		\	D8	Q		F8	8	
99	r		B9			D9	R		F9	9	
9A	^	;	BA		S	DA			FA		
9B			BB		T	DB			FB		
9C			BC		U	DC		0	FC		
9D			BD])	DD		1	FD		
9E			BE		W	DE		2	FE		
9F		}	BF		X	DF		3	FF		



Acronyms and Abbreviations

ASCII	American National Standard Code for Information Interchange
ccnv	Code Converter utility
DAT	digital audio tape
EA	EBCDIC/ASCII (refers to EBCDIC-to-ASCII and ASCII-to-EBCDIC)
EBCDIC	extended binary-coded decimal interchange code
FAL	File Access Library
FCU	File Conversion Utility
FX	Hitachi File Exchange
GUI	graphical user interface
mta	mainframe-to-open
MVS	Multiple Virtual Storage
NSC	Hitachi TagmaStore Network Storage Controller
OJE	open job entry
OS	operating system
otm	open-to-mainframe
oto	open-to-open
SAM	sequential-access method, System Administration Manager (HP-UX)
TAR	tape archive (file format)
UOC	user's own coding
USP	Hitachi TagmaStore Universal Storage Platform
USP V/VM	Hitachi Universal Storage Platform V/VM
VSE	Virtual Storage Extended
VSP	Hitachi Virtual Storage Platform
VSP G1000	Hitachi Virtual Storage Platform G1000

Hitachi Data Systems

Corporate Headquarters

2845 Lafayette Street
Santa Clara, California 95050-2639
U.S.A.

www.hds.com

Regional Contact Information

Americas

+1 408 970 1000

info@hds.com

Europe, Middle East, and Africa

+44 (0) 1753 618000

info.emea@hds.com

Asia Pacific

+852 3189 7900

hds.marketing.apac@hds.com



MK-94RD253-04